

 **TOYOTA**
SUPRA

ELECTRICAL WIRING DIAGRAM

配線図集

JZA8 # 系 (1993-5 ~ 2002-8)

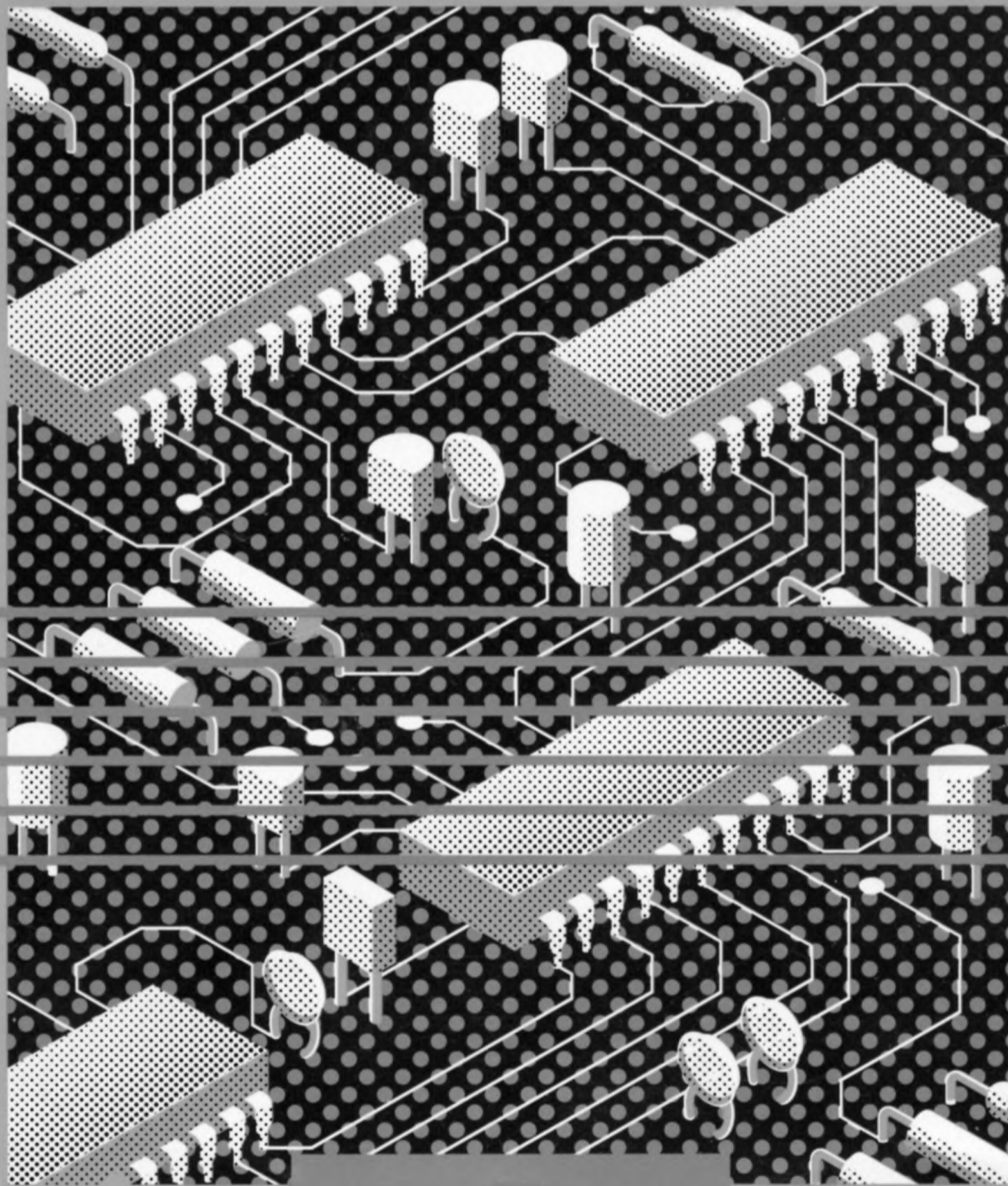

Supra

Wiring Diagrams

J Z A 8 # Series

(1993-5 ~ 2002-8)

Foreword

This is JDM Supra wiring diagram book. It covers whole production range since 1993 till 2002. It was bought a few years ago by our member Paul. In December 2013 it was scanned, OCRed and completely translated by me (Alex (beast_drc)). There are two things, that I excluded from the release: Japanese Index and By-Connector-Number Index. But I think I will include the latter later.

If you found any mistake or issue please contact me: lexalm@gmail.com

If you want to donate for my work, you can do it via PayPal: lexalm@gmail.com

Alex (beast_drc)
Supra club Russia
3 Jan 2014

Document version 1.0

Supra

Wiring Diagrams

JZA8 # Series

(1993-5~2002-8)

Inspection of the electrical wiring of the Supra, this document is a reference to the repair.

Please use in conjunction addition to this book, so we have issued new car manual, repair manual as maintenance related materials of this vehicle.

This document is Yes Ask me for a full wiring diagram of the vehicle that was produced from May 1993.

If you are different from the contents of this document due to change of specification, issue the replacement version if necessary.

December 2002 PN 6742505

トヨタ自動車株式会社
サービス部

History table (It shows the history of the issue wiring diagram compilation)

Issuance	Part number	Cost	Print	Publication
Wiring diagram compilation file cover (type A)	6 8 3 6 1	1300 Y	17.5.1993	24.5.1993
Supra wiring diagram compilation (JZA8 # system)	—	—	17.5.1993	24.5.1993
Supra wiring diagram compilation replacement version (JZA8 # system)	—	—	27.7.1994	3.8.1994
Supra wiring diagram compilation replacement version (JZA8 # system) [All the pages in the replacement part number 6742503]	—	—	2.5.1995	10.5.1995
Supra wiring diagram compilation replacement version (JZA8 # system) [All the pages in the replacement part number 6742504]	—	—	17.4.1996	24.4.1996
Supra wiring diagram compilation replacement version (JZA8 # system) [All the pages in the replacement part number 6742505]	—	—	22.8.1997	29.8.1997
Supra wiring diagram compilation replacement version (JZA8 # system)	6 7 4 2 5 0 5	3900 Y	20.12.2002	20.12.2002

Review article

1

Wiring diagram outfitting
and relay location

2

Wiring diagrams

3

Common connector

4

Index

5

1 Review article

Full book constitutes.....	1-2
Full square each chapter	
2 Wiring diagram outfitting and relay position location	
● Wiring outfitting charts	1-3
● Relay location.....	1-4
3 Wiring diagram chapter	
● Ground diagram.....	1-5
● Wiring diagram.....	1-6
4 Common connectors chapter	
● Junction block / relay block....	1-8
● Wire to wire	1-9
5 Index chapter	
● Index.....	1-10
Abbreviation.....	1-11
Symbol commentary.....	1-12

1-2 Review article

Full book constitutes

Note: The illustrations in the text is different from the contents of this document.

This document is organized in five chapters by the following description.

As for the 2-4 Chapter, it is assumed that you see in the next books.

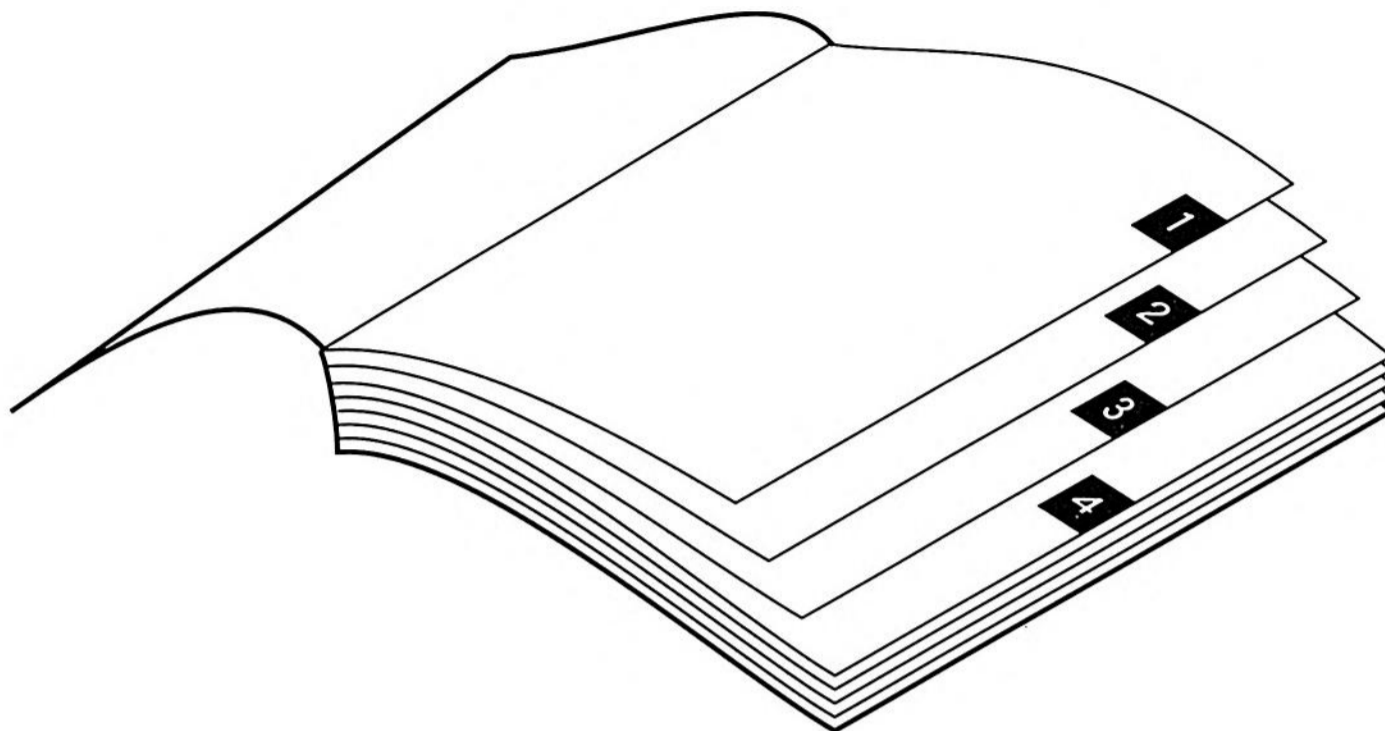

1 Review article

Including the organization of this document, a description of the abbreviations used in the wiring diagram, to read each chapter, and a note on treats take of this document are listed

2 Outfitting wiring diagram And relay location

Parts name to connect to it the wire harness that is used in the vehicle each part engine room, such as the instrument panel, mounting location of the connector, connector shape, the connector one No. Has been described wiring rigging diagram.

Vehicle mounting position relay, the relay block (R / B), Junction Block (J / B), such as a computer is described relay location.

3 System wiring diagram

Consists of a system-specific wiring diagrams. Grounding system diagram power, power. Grounding system diagram is described ground load and fuse load, each wiring diagram power supply circuit, such as an engine relationship has been described by system wiring diagram

4 Common connectors

Can be found in connector to connect to the junction block and (J / B), relay, fuse, the internal circuitry diagrams.

Connector type for connecting the wire harness and the wire harness has been described wire to wire.

5 Index

Outfitting wiring diagrams and described one page of each connector on the system by wiring diagram is described. I will do from the part name or connector No. Search.

Full square each chapter

Chapter wiring diagram outfitting and relay position location

Wiring installed outfitting charts

It shows the part name to connect to it mounting position the wire harness that is used in various parts vehicle, connectors, junction block, relay block, grounding point, connectors and No. (Each connector No., Symbols and system-specific wiring diagram

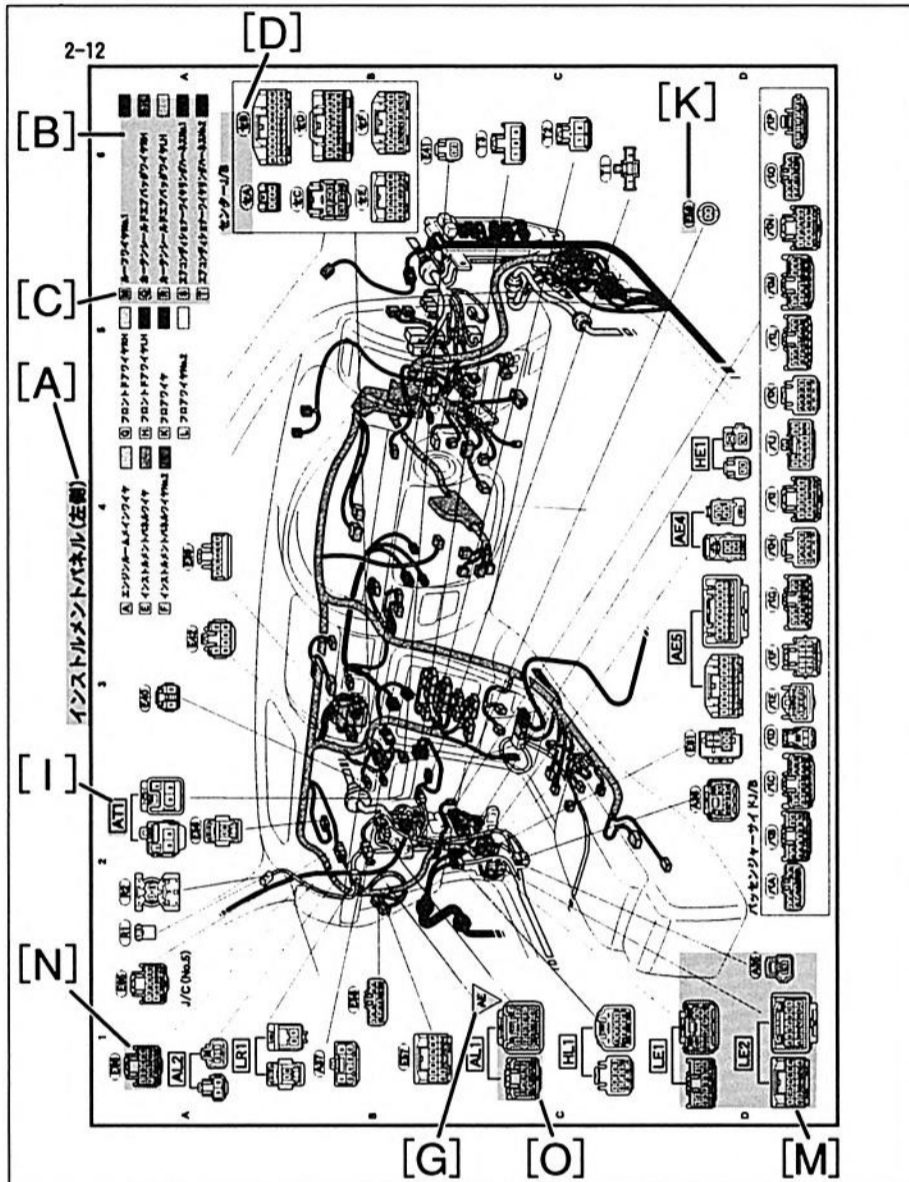

- [A] **Title**
It indicates whether the wiring diagram of outfitting any position of the vehicle
- [B] **Wire harness name**
It shows the color-coded with the name of the wire harness.
- [C] **Wire harness symbol**
This symbolized each wire harness, will first letter of the symbol of ground points from components and connectors for No. Wire to wire connector No...
- [D] **Junction block**
It shows the symbol of the connector to be connected to the name of the junction block.
- [E] **Junction block connector one No.**
It shows the symbol of the connector to connect to the junction block
- [F] **Wire to the junction block name**
It shows the name of the wire harness that connects to it the name of junction block
- [G] **Grounding point symbol**
It shows the symbol of the position at which the ground.
- [H] **Grounding point name**
It shows the name of the position to be ground.
- [I] **Wire to wire connector No.**
It shows the symbol of one connector to connect the wire harness and wire harness.
- [J] **Wire to wire name**
It lists the name of the wire harness and wire harness to connect.
- [K] **Parts of the connector.**
It shows the symbol of the connector to be connected to the component.
- [L] **Parts name**
It shows the name of the parts that connect the connector.
- [M] **One location Chillon**
For example, if "C-1", to examine the extent to which the intersection of column "1" rows and wiring outfitting view of the page in the "C", find the connector No. •, the tip of the lead line is the connector I shows the location of the Star.
- [N] **Parts for connector shape**
It shows the connector shape of the wire harness side that connects to the component. Numbers in the Pin number.
- [O] **Wire to wire connector shape**
It shows the shape of one connector to connect the wire harness and wire harness. Number indicates the terminal number.

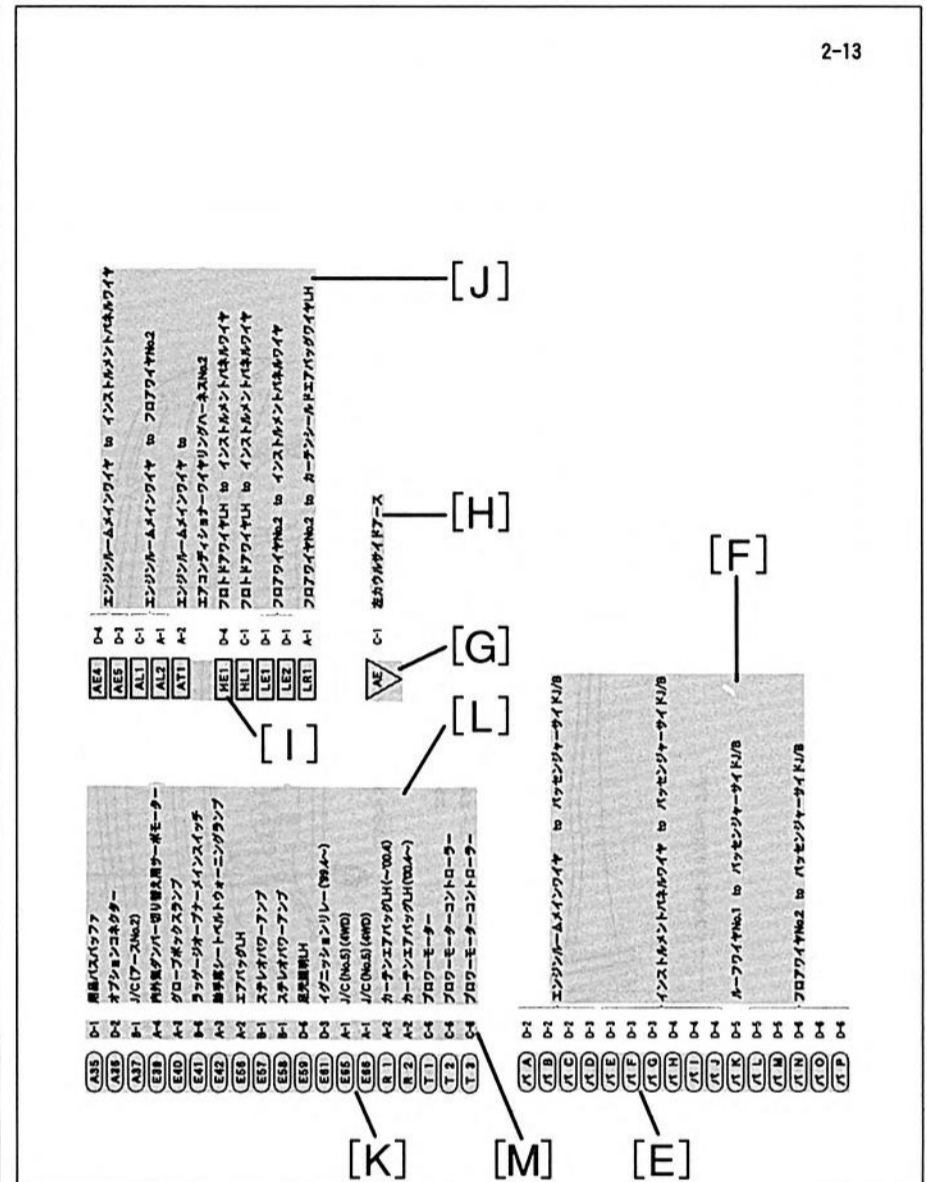

- [A] **Title**
It indicates whether the wiring diagram of outfitting any position of the vehicle
- [B] **Wire harness name**
It shows the color-coded with the name of the wire harness.
- [C] **Wire harness symbol**
This symbolized each wire harness, will first letter of the symbol of ground points from components and connectors for No. Wire to wire connector No...
- [D] **Junction block**
It shows the symbol of the connector to be connected to the name of the junction block.
- [E] **Junction block connector one No.**
It shows the symbol of the connector to connect to the junction block
- [F] **Wire to the junction block name**
It shows the name of the wire harness that connects to it the name of junction block
- [G] **Grounding point symbol**
It shows the symbol of the position at which the ground.
- [H] **Grounding point name**
It shows the name of the position to be ground.
- [I] **Wire to wire connector No.**
It shows the symbol of one connector to connect the wire harness and wire harness.
- [J] **Wire to wire name**
It lists the name of the wire harness and wire harness to connect.
- [K] **Parts of the connector.**
It shows the symbol of the connector to be connected to the component.
- [L] **Parts name**
It shows the name of the parts that connect the connector.
- [M] **One location Chillon**
For example, if "C-1", to examine the extent to which the intersection of column "1" rows and wiring outfitting view of the page in the "C", find the connector No. •, the tip of the lead line is the connector I shows the location of the Star.
- [N] **Parts for connector shape**
It shows the connector shape of the wire harness side that connects to the component. Numbers in the Pin number.
- [O] **Wire to wire connector shape**
It shows the shape of one connector to connect the wire harness and wire harness. Number indicates the terminal number.

1-4 Review article

● Relay location

Relay, relay block (R / B), junction block (J / B), fusible link (F / L), ECU
 It indicate which vehicle mounting position.

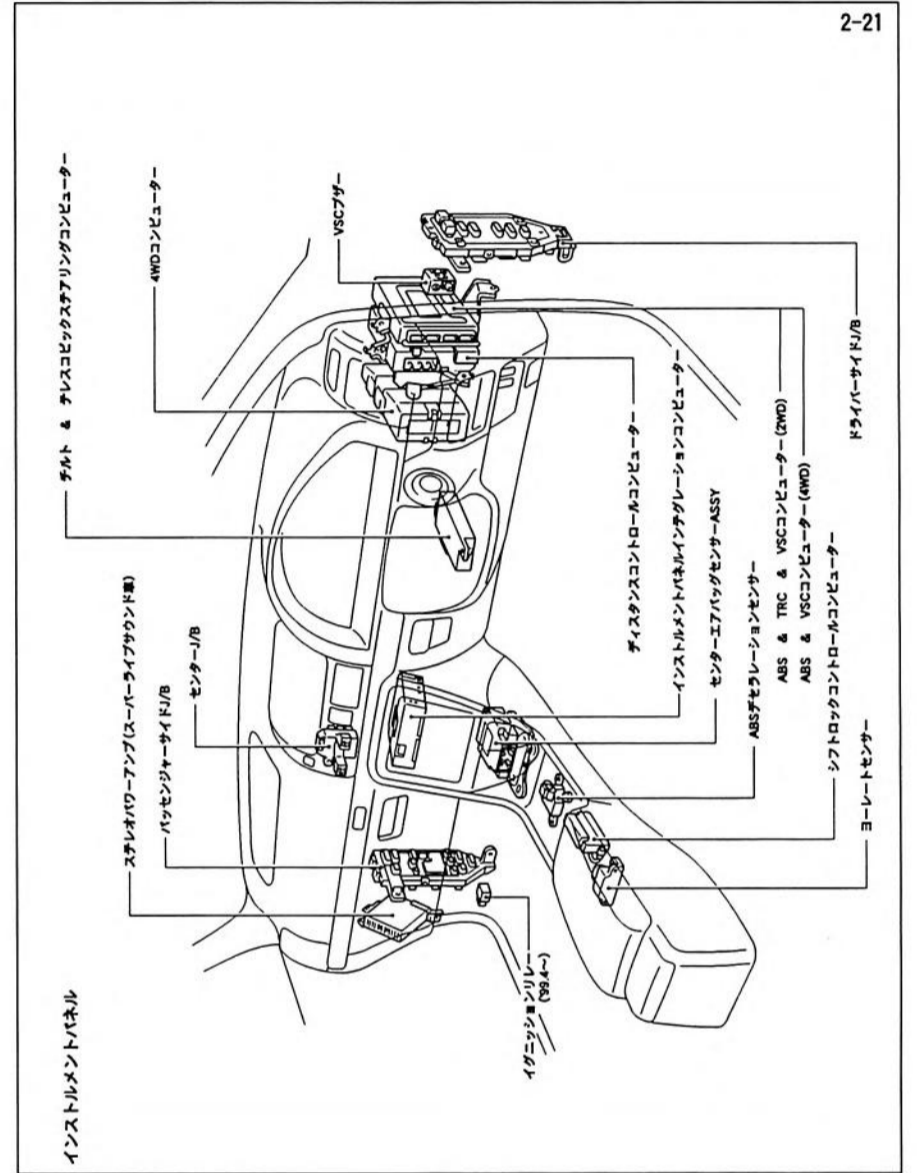
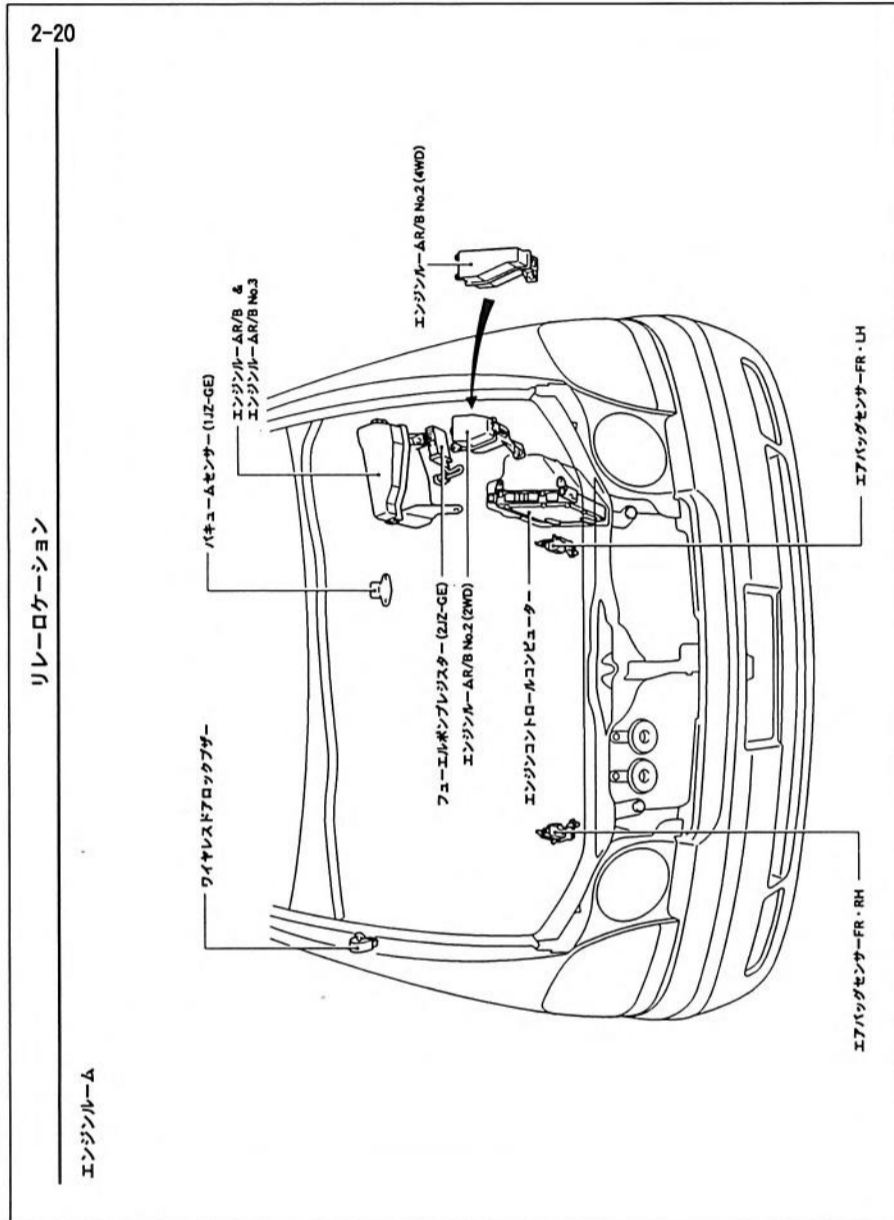

3 System wiring diagram chapter

● Ground power system diagram

Fuses load

It have stated the power fuse, fusible link is whether to supply power to any system.

Ground load

It will show each ground are related to any system.

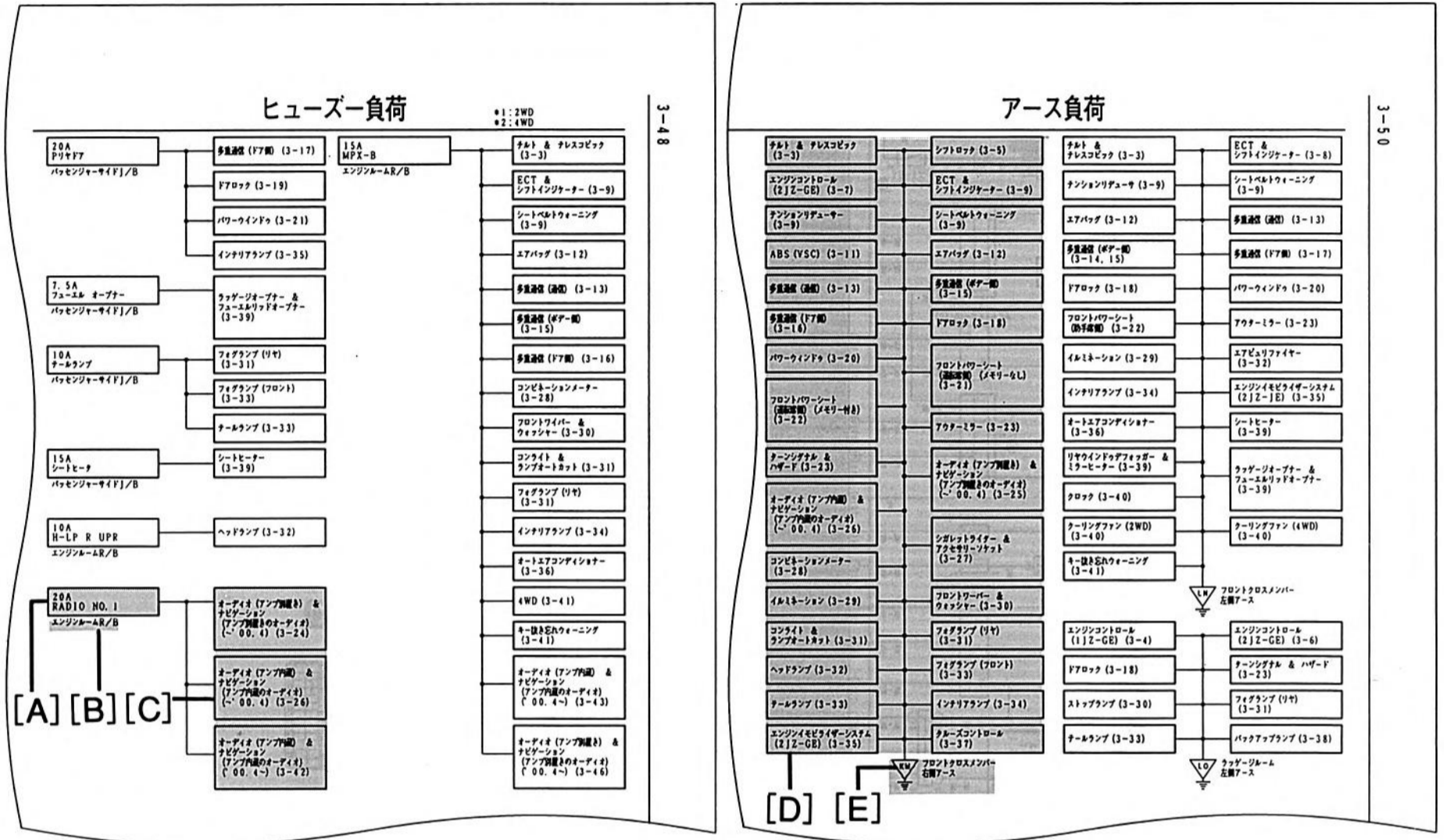

[A] Fuse name

It shows the fuse and fuse capacity name.

[B] Hughes mounting position

I shows the mounting position and vehicle parts name fuse is installed.

In addition, each fuse mounting position within the part will see "Chapter 4 Common connector"

[C] Page described the system name (fuse)

It shows the page that system by wiring diagram and system name that is using the fuse is described.

[D] Page described as the System Name (earth point)

I shows the page that system by wiring diagram and system name that is using each Asubointo is described.

[E] Boyne earth Bok name

I shows the name of the position to be grounded.

●System by wiring diagram

Consists of the following system wiring diagram and power wiring diagram, power supply wiring diagram; been described wiring diagram to fuse from the source, system wiring diagram you have been describing the wiring diagram to ground from the fuse of each system.

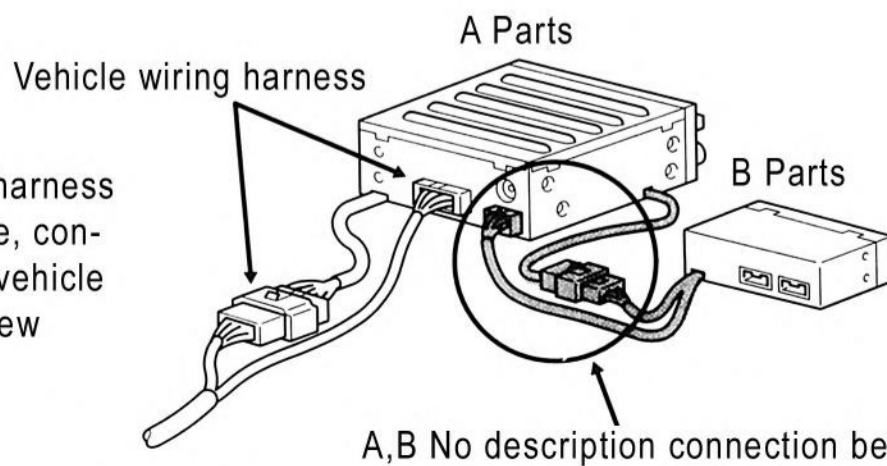
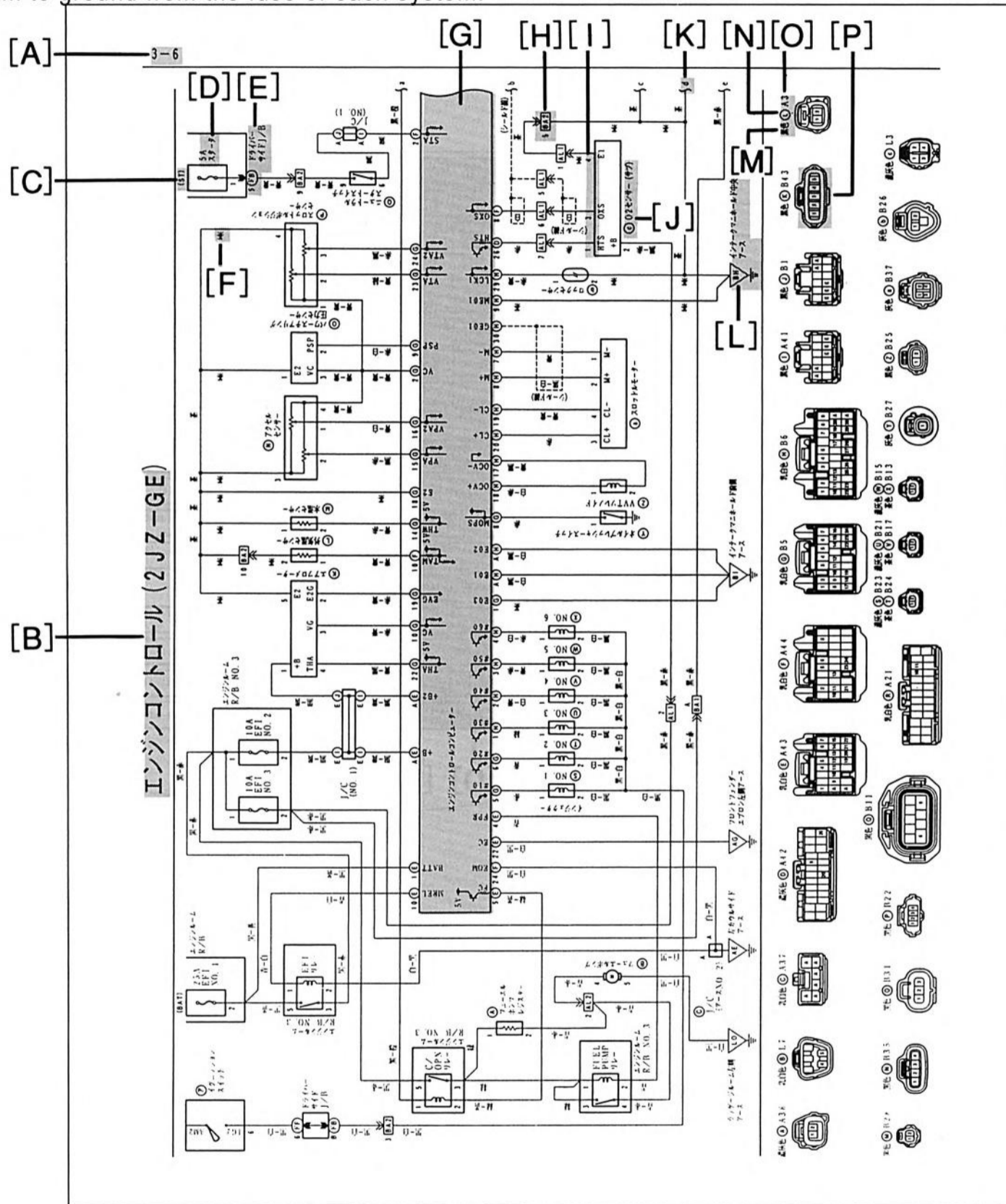

* Links with each component and vehicle wiring harness has been described in this document. Therefore, connections between components without using a vehicle wire harness is not listed. Please refer to the new model manual, repair manual.

A,B No description connection between components

The paper structure

Upper row shows a circuit diagram of a system, I will show the parts for connectors used in the system is lower.
Evening one connector on the other refers to the "one common connector 4 Chapter evening".

- [A] **Section page**
I shows the page of the section.
- [B] **Title**
I shows the name of the system.
- [C] **Identification of a power supply system**
I shows the position of the ignition key while the power is supplied to the fuse.
- [D] **Fuses name**
I lists the name and capacity of the fuse. Fuse mounting position refers to the "Chapter 4 common connector."
- [E] **Junction block (J / B)**
I indicates the number of the connector to be connected to the (J / B) junction block and the name of the junction block (J / B). One shape connector evening or browse "2 Akiratori his own line IyaSo-zu & relay location" and "Chapter 4 common connector."

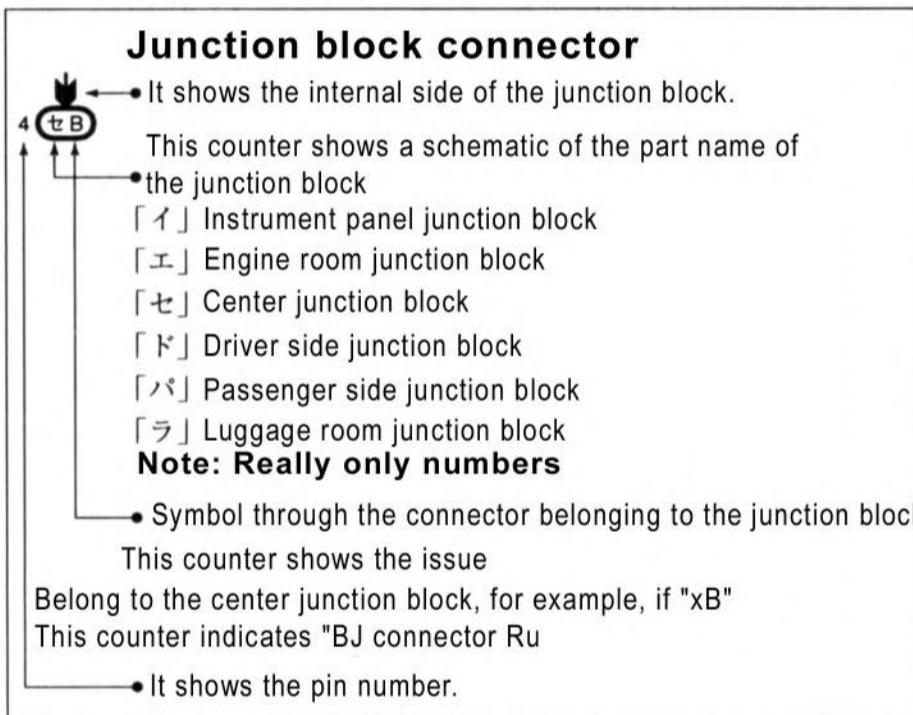

- [F] **Line color**
It will show the color of the wire harness.
For example, if it is visible two colors [B-W], It shows the wire-harness that white line to enter the black ground.



- [G] **Internal circuit**
It shows the internal circuit of the relay, the input and output circuit of the computer.

- [H] **Wire to wire harness No.**
I shows the symbol of the connector to connect the wire harness and wire harness.
Connector type or browse to "2 Akiratori his own line view and relay location" and "Chapter 4 common connector."

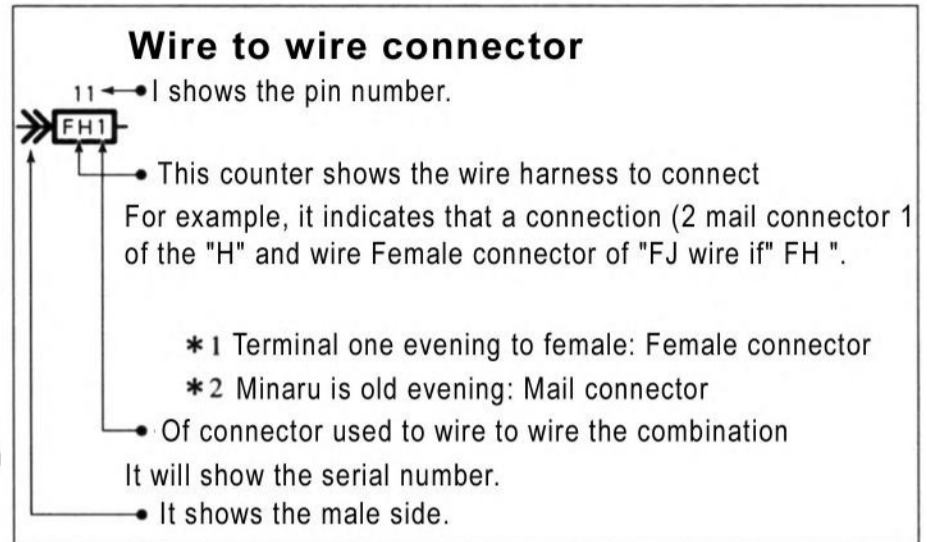

- [I] **Terminal number**
It shows the pin number of the connector to be connected.
- [J] **One symbol and connector parts name**
It shows the connector symbol to connect to it and each component name.
Connector symbol is related to the following view of the connector.
- [K] **Page connection symbol**
Symbol indicates that you are connected to the one-ness of Waiyaha same symbol on the next page.
- [L] **Earth point Bok symbol**
It lists the symbolic position and grounded.

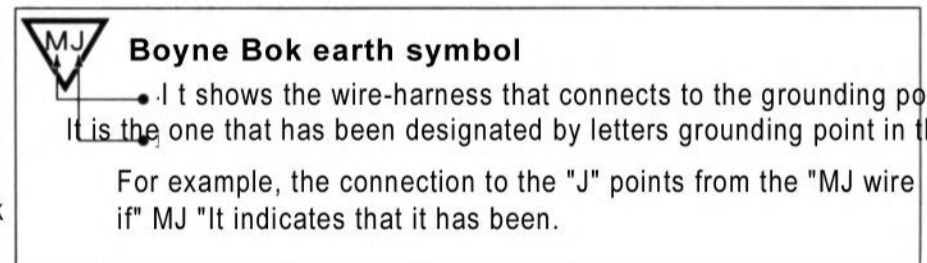

- [M] **Connector color**
It will show the color of the connector
- [N] **Connector symbol**
In connection with the symbol in the circuit diagram above, it indicates that connector
- [O] **Parts for connector No.**
It shows the connector number to connect to the component.
This is the same as the wiring diagram outfitting.

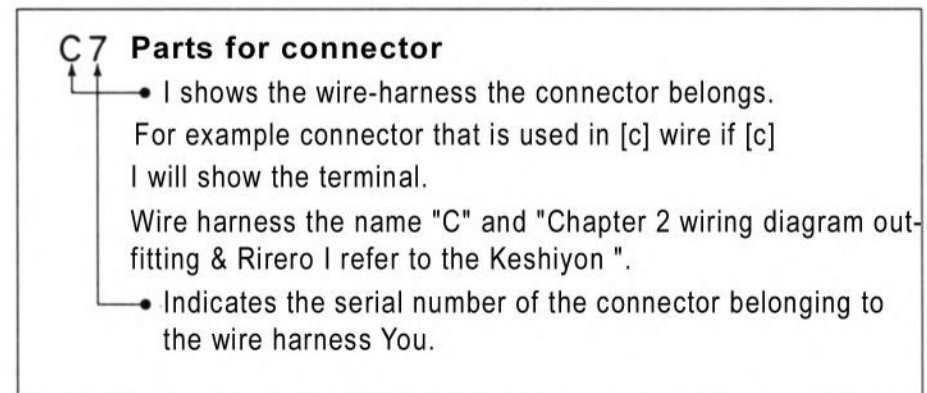

- [P] **Terminal connector number and shape**
The one shows the shape of the wire harness connector side to be connected to the partsWill.
Numbers indicate the position of the terminal number that you are using in the circuit diagram.

4 Chapter common connector

● Junction block (J / B) / relay block (R / B)

Connector to connect to the junction block and (J / B), relay, fuse, and you have been describing the internal circuit.

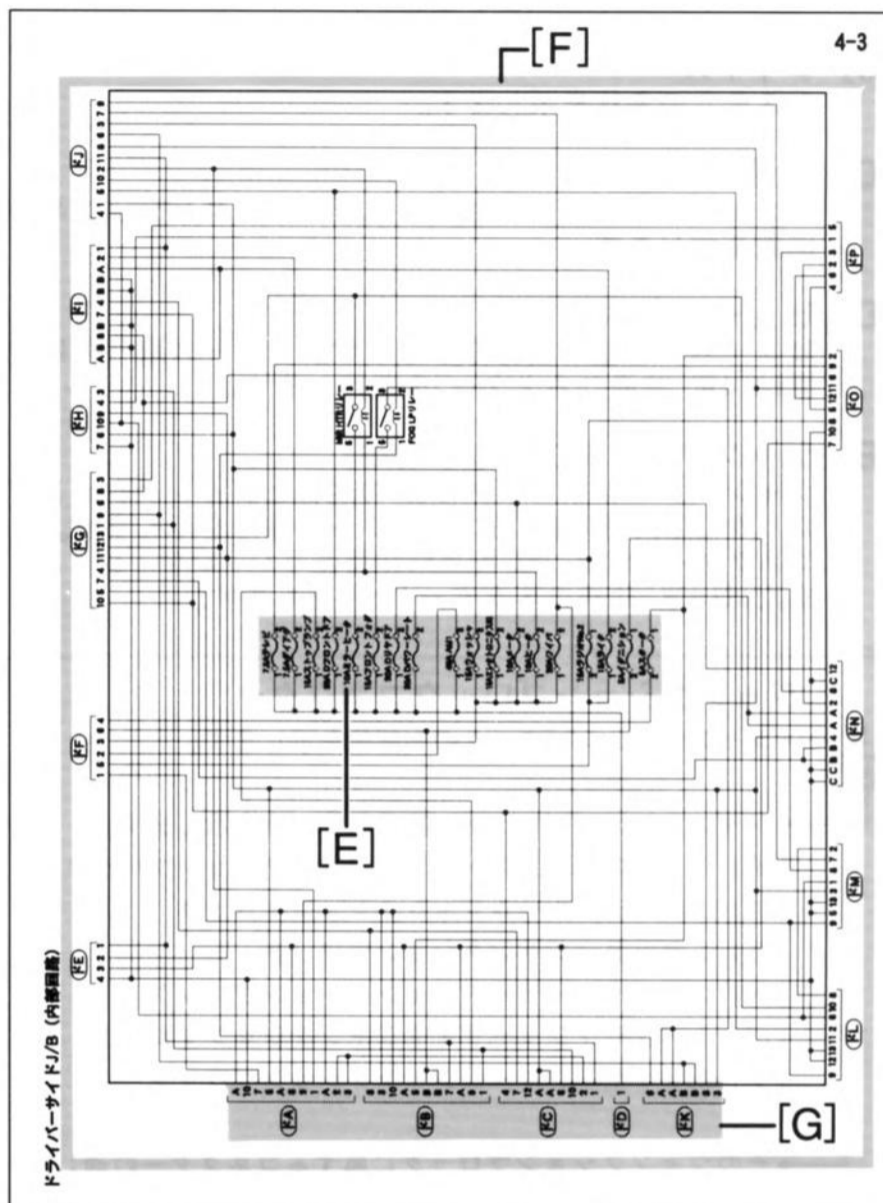
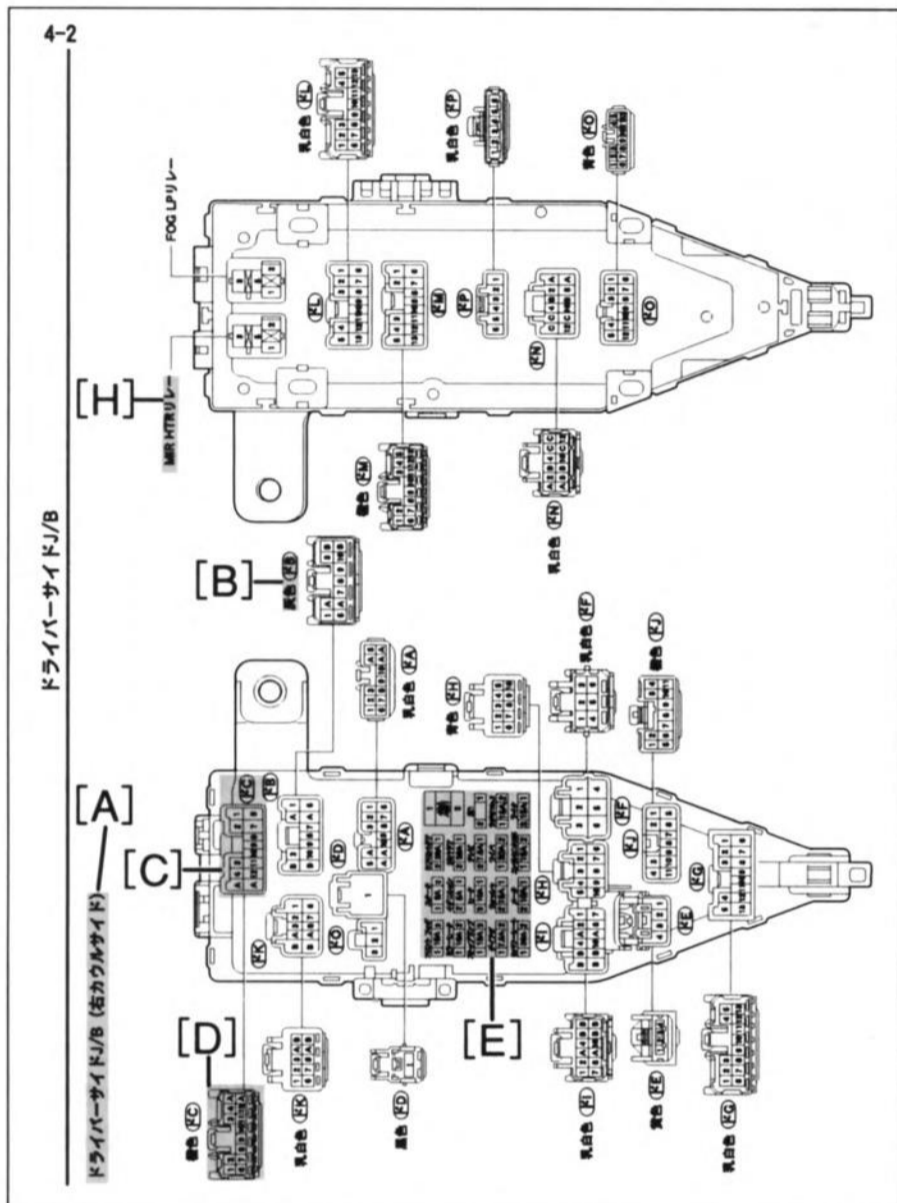

[A] Junction block / "relay block name

It lists the name of the junction block / relay block

[B] Connector color and connector No •

It shows the color and number of the connector that connects to the junction block.

[C] Terminal connector number and shape

It shows the shape of the connector of junction block side. Number indicates the terminal number.

[D] Terminal connector number and shape

It shows the shape of the evening one connector of the wire harness side. Number indicates the terminal number.

[E] Fuse name

It shows the fuse and fuse capacity name.

[F] Internal circuit

It shows the internal wiring circuit of the junction block.

[G] Terminal number and connector No •

It shows the terminal number and number of one connector to connect to junction block.

[H] Relay name

It lists the name of the component is attached to the junction block.

● **Wire to Wire**

It is mentioned a list of the connector to connect the wire harness and wire harness.

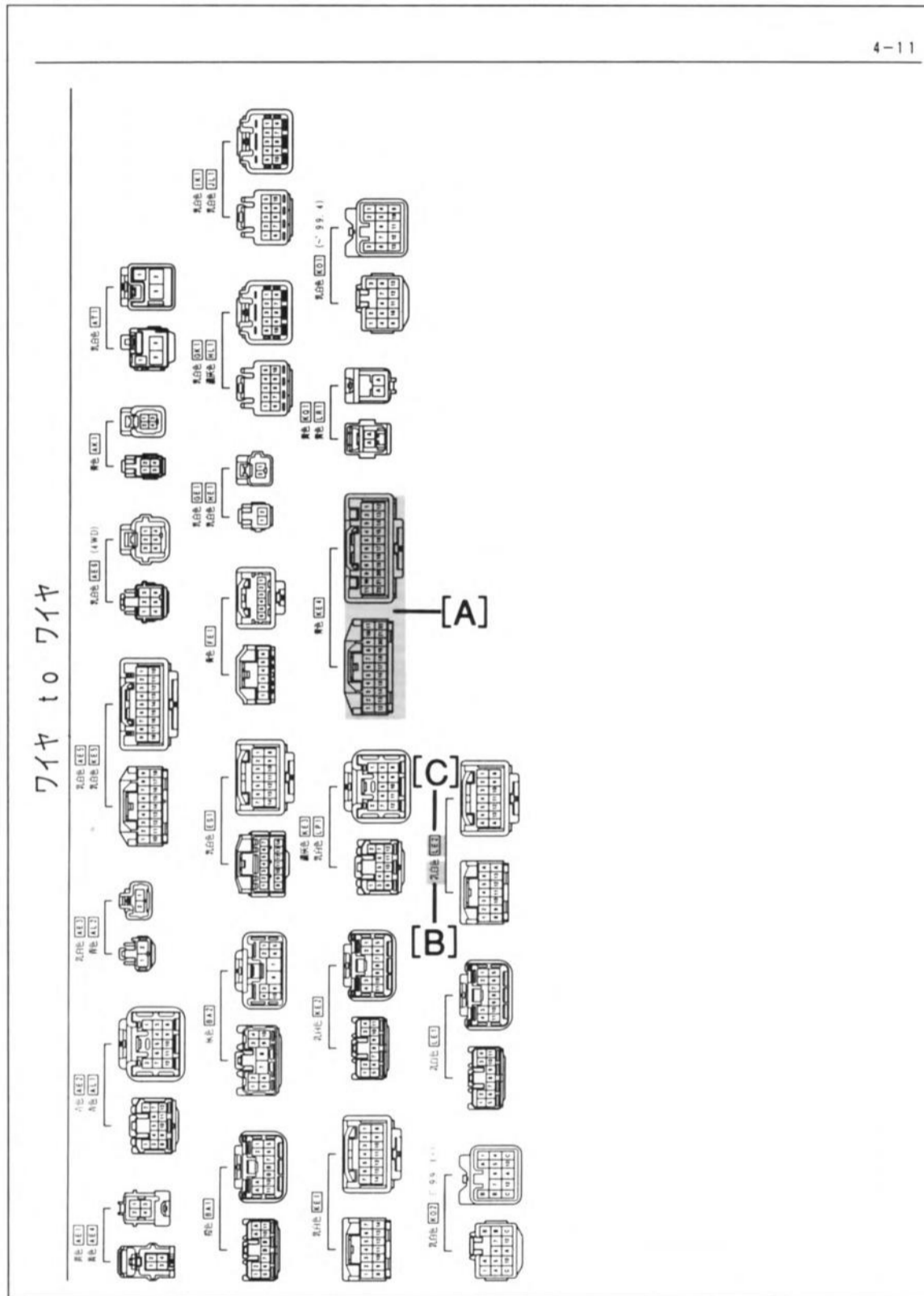

[A] **Terminal connector number and shape**

It shows the connector shape to connect the wire harness and wire harness.
 (Connector of the K-wire in this case) Female connector * 1 shape: left
 (Connector of the E-wire in this case) mail connector * 2 shape: right
 1 Female connector: terminal female
 2 mail connector: terminal male
 Numbers indicate the position of the terminal number.

[B] **Connector color**

It will show the color of the connector.

[C] **Wire to wire connector No.**

It shows the connector No • connect wire harness and wire harness.
 It is a common wiring diagram rigging, and system-specific wiring diagram.

5 Chapter Index

● Index

Outfitting wiring diagrams and description page of each connector on the system by wiring diagram is described. Index is done from the component name or connector No..
Index entries are grouped parts, wire to wire, junction block (J / B).

部品名	コネクタ No.	システム別配線図 ページ	配線構築図 ページ
J/C (アースNo. 6)	K 1 1	3-4,6,29,31,32,34,36,49,50	2-18
J/C (アースNo. 7)	M 7	3-15,18,19,25,26,29,31,32,33,55	2-18
O/Dスイッチ & ソフトスイッチ	E 2 6	3-9,11,14,28,39	2-13
O ₁ センサー	B 5 2	3-4	2-4
O ₁ センサー-LH	B 6 4	3-34	2-7
O ₁ センサー-No. 1	B 7 1	3-36	2-10
O ₁ センサー-No. 2	B 8 6	3-37	2-10
O ₁ センサー-RH	B 6 5	3-34	2-7
O ₁ センサー-RR LH	K 2	3-7	2-17
TRC OFFスイッチ	E 2 1	3-13,28,45	2-13
TVチューナー	J 1 1	3-20,25	2-18
TVチューナー	J 1 2	3-20,23,25	2-18
TVチューナー	J 1 8	3-48,50	2-18
TVチューナー	J 2 1	3-48,50	2-18
VSCブザー	D 4 3	3-45	2-14
VSV (ACM)	B 4 0	3-6,34	2-7
VSV (エアゲ)	B 3 7	3-6,34	2-7
VSV (エアゲ)	B 4 4	3-4	2-4
VSV (エアゲ)	B 6 7	3-36	2-10
VSV (可変吸気No. 1)	B 3 3	3-6,34	2-7
VSV (可変吸気No. 2)	B 3 6	3-6,34	2-7
VVTソレノイド	B 8 5	3-37	2-10
VVTソレノイドLH	B 1 6	3-7,35	2-7
VVTソレノイドRH	B 1 7	3-7,35	2-7
アウターミラースイッチ	E 1	3-19	2-14
アンテナアンブ	E 3 1	3-20,21,22,24,39,47,48,50	2-13
イグナイター-No. 1	B 2 5	3-3,7,35,40	2-7
イグナイター-No. 1	B 4 9	3-3,4	2-4
イグナイター-No. 1	B 7 5	3-36,40	2-10
イグナイター-No. 2	B 3 1	3-3,7,35,40	2-7
イグナイター-No. 2	B 4 7	3-3,4	2-4
イグナイター-No. 2	B 7 4	3-36,40	2-10
イグナイター-No. 3	B 2 3	3-3,7,35,40	2-7
イグナイター-No. 3	B 7 3	3-37,40	2-10
イグナイター-No. 4	B 3 2	3-3,7,35,40	2-7
イグナイター-No. 4	B 7 6	3-37,40	2-10
イグナイター-No. 5	B 2 1	3-3,7,35,40	2-7
イグナイター-No. 6	B 3 5	3-3,7,35,40	2-7
イグニッションキー-開閉	D 1 3	3-14,33	2-14
イグニッションスイッチ	D 1 1	3-2,3,4,6,31,34,36,40	2-14
インジェクター-No. 1	B 2 6	3-6,34	2-7
インジェクター-No. 1	B 5 7	3-4	2-4
インジェクター-No. 1	B 8 2	3-36	2-10
インジェクター-No. 2	B 3 0	3-6,34	2-7
インジェクター-No. 2	B 5 6	3-4	2-4
インジェクター-No. 2	B 8 1	3-36	2-10
インジェクター-No. 3	B 2 7	3-6,34	2-7
インジェクター-No. 3	B 5 4	3-4	2-4
インジェクター-No. 3	B 8 0	3-36	2-10
インジェクター-No. 4	B 3 4	3-6,34	2-7
インジェクター-No. 4	B 4 5	3-4	2-4
インジェクター-No. 4	B 7 7	3-36	2-10
インジェクター-No. 5	B 2 8	3-6,34	2-7
インジェクター-No. 6	B 3 8	3-6,34	2-7
ウォッシュモーター	A 1 3	3-26	2-3,6,9
エアコンコンピューター & コンビネーションメーター	E 5	3-4,7,8,10,12,13,23,29,30	2-13
エアコンコンピューター & コンビネーションメーター	E 6	3-2,4,7,8,9,10,11,12,13,14,16 3-17,18,20,23,25,27,29,30,32,33 3-35,36,38,41,42,43,44,46,49,51 3-52,53,54,55	2-13
エアコンコンピューター & コンビネーションメーター	E 7	3-30,44,46,52	2-13
エアコンコンピューター & コンビネーションメーター	E 3 7	3-10,29,30,35,36,38,42,44,46,53	2-13
エアバッグLH	D 2 2	3-9,41	2-12
エアバッグRH	D 1 7	3-9,41	2-14
エアバッグインジェクターランプ (助手席)	E 1 8	3-17	2-12
エアフロメーター	B. 6	3-6,34,37	2-7,10

コネクタ No.	部品名	システム別配線図 ページ	配線構築図 ページ	品番
B 6 5	O2センサー-RH	3-34	2-7	11028
B 6 6	コンデンサー (ラジオ)	3-40	2-7	10843
B 6 7	VSV (エアゲ)	3-36	2-10	11156
B 6 8	水温センサー	3-37,38	2-10	10737
B 6 9	オイルプレッシャースイッチ	3-37	2-10	11363
B 7 0	カムポジションセンサー	3-36	2-10	10947
B 7 1	O2センサー-No. 1	3-36	2-10	11028
B 7 2	コンデンサー (ラジオ)	3-40	2-10	10843
B 7 3	イグナイター-No. 3	3-37,40	2-10	11885
B 7 4	イグナイター-No. 2	3-36,40	2-10	11885
B 7 5	イグナイター-No. 1	3-36,40	2-10	11885
B 7 6	イグナイター-No. 4	3-37,40	2-10	11885
B 7 7	インジェクター-No. 4	3-36	2-10	11875
B 7 8	スロットルポジションセンサー	3-37,38	2-10	11261
B 7 9	ISC V	3-36	2-10	11145
B 8 0	インジェクター-No. 3	3-36	2-10	11875
B 8 1	インジェクター-No. 2	3-36	2-10	11875
B 8 2	インジェクター-No. 1	3-36	2-10	11875
B 8 3	ノックセンサー	3-36	2-10	11166
B 8 4	パワーステアリング圧力スイッチ	3-37	2-10	11428
B 8 5	VVTソレノイド	3-37	2-10	11162
B 8 6	O2センサー-No. 2	3-37	2-10	10869
B 8 7	クラッチポジションセンサー	3-36	2-10	10947
C 1	バッテリー+	3-340	2-4,7,10	-
C 2	スターター	3-340	2-4,7,10	-
D 1	J/C (アースNo. 4)	3-9,11,12,13,14,16,18,22,23 3-26,27,28,29,30,31,32,41 3-43,45,46,52,54,55	2-14	10926
D 2	ABS & TRCコンピューター	3-6,13,23	2-14	11391
D 3	ABSコンピューター (TRCなし)	3-12,23	2-14	11390
D 4	J/C (No. 4)	3-4,5,7,8,9,11,12,15,25,30 3-31,38,42,44,45,49,51	2-14	11542
D 5	J/C (No. 5)	3-3,4,6,8,9,11,14,17,18,19 3-29,55	2-14	11542
D 6	ステレオパワーアンブ	3-21,24,47,50	2-14	10848
D 7	ステレオパワーアンブ	3-21,24,47,50	2-14	10807
D 8	ストップランプスイッチ	3-5,7,8,10,12,13,14,17,32 3-35,37,38,42,44,53	2-13	11118
D 9	ターンシグナルフラッシュャーリレー	3-23,29,46	2-14	10799
D 10	D L C 3	3-4,7,8,9,11,12,13,15,35,36 3-38,41,42,44,49,51,53	2-14	11978
D 11	イグニッションスイッチ	3-2,3,4,6,31,34,36,40	2-14	11615
D 12	キーアンロックウェーニングスイッチ	3-11,14,18	2-14	10860
D 13	イグニッションキー-開閉	3-14,33	2-14	10906
D 14	キーインターロックソレノイド	3-17	2-14	10825
D 15	コンビネーションスイッチ	3-15,26	2-14	11594
D 16	コンビネーションスイッチ	3-9,11,29,39,53	2-14	11616
D 17	エアバッグRH	3-9,41	2-14	10850
D 18	コンビネーションスイッチ	3-14,23,27,28,29,32,46,52 3-54,55	2-14	11671
D 19	パーキングブレーキスイッチ	3-15,20,23,25,43,45,46,49 3-51	2-13	10871
D 21	センターエアバッグセンサー-ASSY	3-9,15,23	2-13	11868
D 22	エアバッグLH	3-9,41	2-12	11884
D 23	J/C (アースNo. 3)	3-15,16,18,22,26,29,30,31 3-33,54	2-12	10976
D 24	サイドターンLH	3-29	2-3,6,9	11162
D 25	オブションコネクタ	3-3	2-3,6,9	11028
D 26	ABSスピードセンサー-FR・LH	3-12,13,43,45	2-3,6,9	11075
D 27	ダイヤルシフトコネクタ	3-4,7,8,9,10,12,13,15	2-3,6	11195
D 28	フロントエアバッグセンサー-LH	3-9,41	2-3,6,9	11856
D 29	J/C (No. 6)	3-14,16,18,33	2-12	11542
D 30	マルチプレックスネットワークボデーコンピューター	3-14,16,18,33,54,55	2-12	11955
D 31	マルチプレックスネットワークボデーコンピューター	3-9,11,14,17,18,23,26,30,32 3-33,41,46	2-12	11956
D 32	マルチプレックスネットワークボデーコンピューター	3-2,4,7,9,11,14,16,18,23,26	2-12	11954

コネクタ一挿給の有無はW/Hリペアマニュアルのハウジング品番一覧表を確認してください。(00/10 品番12345)

[C]

[D]

[E]

[D]

[C]

[E]

[F]

[A] Parts name order index

System-specific wiring diagram that is mentioned in the connector with the connector No. Then the name of the parts, components and order name index to find the page of the wiring diagram outfitting.

[B] One connector No. Order index

System-specific wiring diagram that is mentioned in the connector and part name from connector No., And connector No. Order index to find the page of wiring Giso-zu.

[C] Parts name

I assigned the name of the component to be connected.

[D] One connector No.

I indicates the number of the connector.

System-specific wiring diagram and will be shared with the wiring diagram outfitting

[E] System-specific wiring diagram page / wiring diagram outfitting page

System-specific wiring diagram that is described in the one connector each, and I shows the page of the wiring diagram outfitting.

[F] Part Number (90980 -)

I shows the last five digits of those 5-digit above 90,980 for part of the factory during the assembly of the connector. Check the housing part number list of W / H repair manual presence or absence of supply connector.











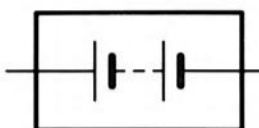

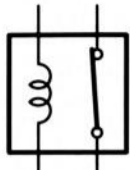

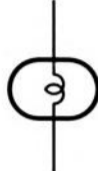
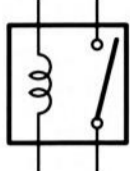

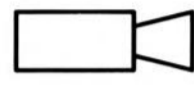

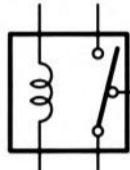
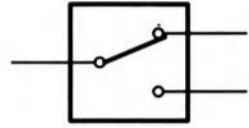



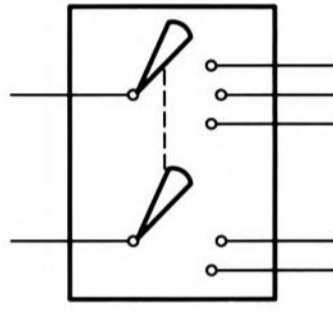

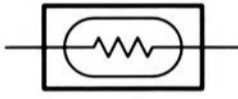
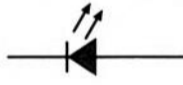
Abbreviation

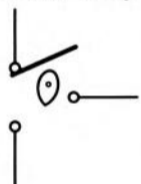
I'm using the term as a term, such as the following in this document.

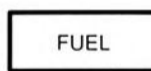
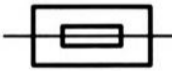
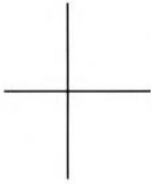
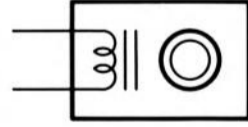
ABBR	Description
ABS	Antilock brake system
A/T	Automatic transaxle
ECT	Electronic controlled transmission
FR	Front
ISCV	Idle speed control valve
J/B	Junction block
J/C	Junction connector
LH	Left Hand
M/T	Manual transaxle
O/D	Overdrive
RH	Right hand
RR	Rear right
R/B	Relay blocks
TRC	Traction control
VSV	Vacuum switching valve
VVT	Continuous variable valve timing mechanism

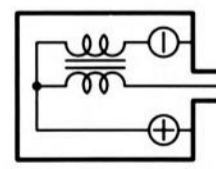
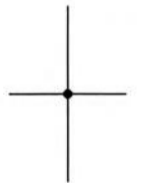
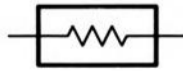
1-12 Review article

Symbol commentary

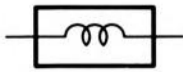
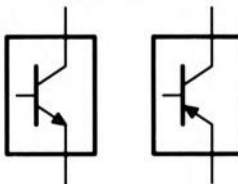
<p>Battery</p> 	<p>Ground</p> 	<p>Relay</p>  <p>1. Normal Closed</p>	<p>Switch</p>  <p>1. Normal Opened</p>
<p>Capacitor (Condenser)</p> 	<p>Head lamp</p>  <p>1. Single filament</p>	 <p>2. Normal Opened</p>	 <p>2. Normal Closed</p>
<p>Cig. lighter</p> 	 <p>2. Double Filament</p>	<p>Double throw relay</p> 	<p>Switch, double throw</p> 
<p>Diode</p> 	<p>Horn</p> 	<p>Tap resistor</p> 	<p>Switch, ignition</p> 
<p>Zener diode</p> 	<p>Lamp</p> 	<p>Sensor</p> 	
<p>LED (Light Emitting Diode)</p> 	<p>Analog meters</p> 	<p>Speed sensor</p> 	<p>Switch, wiper</p> 
<p>Photo diode</p> 	<p>Digital Meter</p> 	<p>Short pin</p> 	<p>Wire</p>  <p>1. Not connected</p>
<p>Distributor</p> 	<p>Motor</p> 	<p>Ignition coil</p> 	 <p>2. Connected</p>
<p>Resistor</p> 	<p>Fuse</p> 	<p>Speaker</p> 	
<p>Rheostat</p> 	<p>Solenoid</p> 	<p>Transistor</p> 	

2 Wiring diagram outfitting & relay location

Wiring installed outfitting Charts

Engine (2JZ-GE)	2-2
Engine (2JZ-GTE)	2-6
Instrument panel	2-10
Body	2-16
Seats	2-20

Relay location

Relay location	2-22
----------------------	------

Wire harness symbol	Wire harness name
A	System engine main wire
B	Engine wiring
C	Cowl wire
D	Cowl No. 2 wire
E	Cowl No. 3 wire
F	Cowl No. 4 wire
G	Instrument panel wire
H	Front door RH wire
I	Front door L H wire
J	Floor wire
K	Floor N o. 3 wire
L	Console box wire
M	Seat wire
N	Roof wire
O	Fuel gauge wire
P	Backdoor N o. 1 wire
Q	Backdoor N o. 2 wire
R	Engine room N o. 2 wire
S	Engine No. 2 wire
T	Power steering wire ground

Engine room (2JZ-GE around)

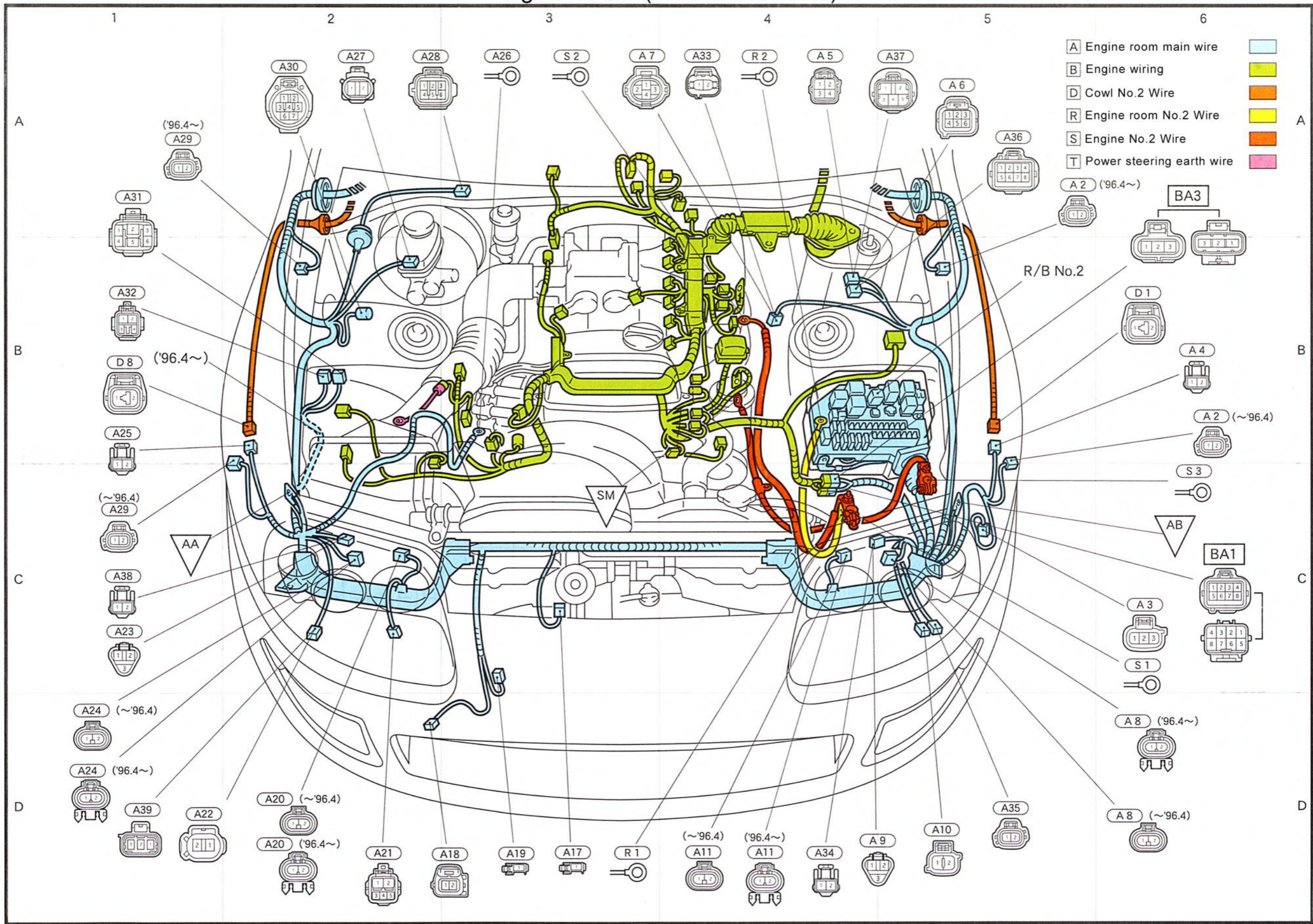

- A Engine room main wire
- B Engine wiring
- D Cowl No.2 Wire
- R Engine room No.2 Wire
- S Engine No.2 Wire
- T Power steering earth wire

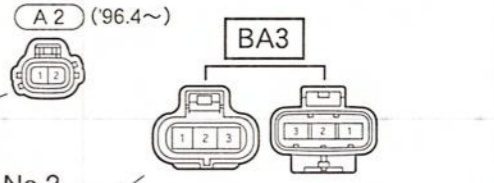

R/B No.2

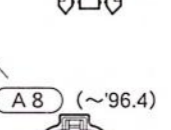
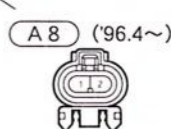
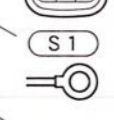
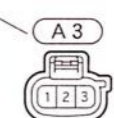
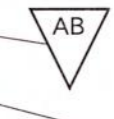
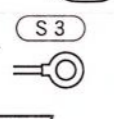
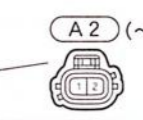
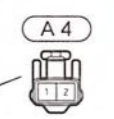
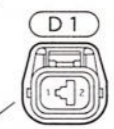

1 2 3 4 5 6

A30 A27 A28 A26 S 2 A 7 A33 R 2 A 5 A37 A 6 A36 A29 ('96.4~) A31 A32 D 8 ('96.4~) A25 A29 (~'96.4) A38 A23 A24 (~'96.4) A24 ('96.4~) A39 A22 A20 (~'96.4) A20 ('96.4~) A21 A18 A19 A17 R 1 (~'96.4) A11 ('96.4~) A34 A 9 A10 A35 A8 ('96.4~) A8 (~'96.4)

AA AB BA3 BA1

R/B No.2

SM

(A 2)	B-6	Side turn LH (~ '96 .4)	(S 2)	A-3	Starter
(A 2)	A-5	Side turn LH (96.4 ~)	(S 3)	C-6	Battery (-)
(A 3)	C-6	Washer motor			
(A 4)	B-6	ABS Speed sensor FR. LH			
(A 5)	A-4	ABS actuator (~, 96.4)			
(A 6)	A-5	ABS actuator (~, 96.4)	(BA1)	C-6	} Engine room main wire and the engine wiring
(A 7)	A-3	Pressure switch (high or low pressure air-side switch and air conditioning during the compression side switch) (~ '94 .8)	(BA3)	A-6	
(A 8)	D-6	Head lamp LH (LO)			
(A 9)	D-4	Fog lamp LH & clearance lamp LH (~ '96 .4)			
(A10)	D-5	Front turn LH	(AA)	C-1	Right fender apron earth
(A11)	D-4	Head lamp LH (ratio)	(AB)	C-6	Left fender apron earth
(A17)	D-3	Horn LH	(SM)	C-3	Engine block ground
(A18)	D-3	Ambient temperature sensor			
(A19)	D-3	Horn RH			
(A20)	D-2	Head lamp RH (HI)			
(A21)	D-2	Spoiler motor (94.8 ~)			
(A22)	D-1	Front turn RH (~ '96 .4)			
(A23)	C-1	Fog lamp RH & clearance lamp RH + (~ 96.4)			
(A24)	D-1	Head lamp RH (LO)			
(A25)	B-1	ABS speed sensor FR. RH			
(A26)	A-3	Alternator			
(A27)	A-2	Brake level warning switch			
(A28)	A-2	Wiper motor			
(A29)	C-1	Side turn RH (~, 96.4)			
(A29)	A-1	Side turn RH (, 96.4 ~)			
(A30)	A-2	Cruise control actuator (~, 95.5)			
(A31)	A-1	ABS relay			
(A32)	B-1	ABS relay			
(A33)	A-4	Pressure switch (high or low pressure air-side switch) ('94 .8 ~)			
(A34)	D-4	Fog lamp LH (96.4 ~)			
(A35)	D-5	Clearance lamp LH ('96 .4 ~)			
(A36)	A-5	ABS actuator (96.4 ~)			
(A37)	A-5	ABS actuator (96.4 ~)			
(A38)	C-1	Fog lamp RH ('96 .4 ~)			
(A39)	D-1	Front turn RH & clearance lamp RH + (96.4 ~)			
(D 1)	B-6	Airbag sensor LH (~, 96.4)			
(D 8)	B-1	Airbag sensor RH (~, 96.4)			
(R 1)	D-3	Battery (+)			
(R 2)	A-4	FL Horta			
(S 1)	C-6	Battery (+)			

Engine room - (2JZ-GE body)

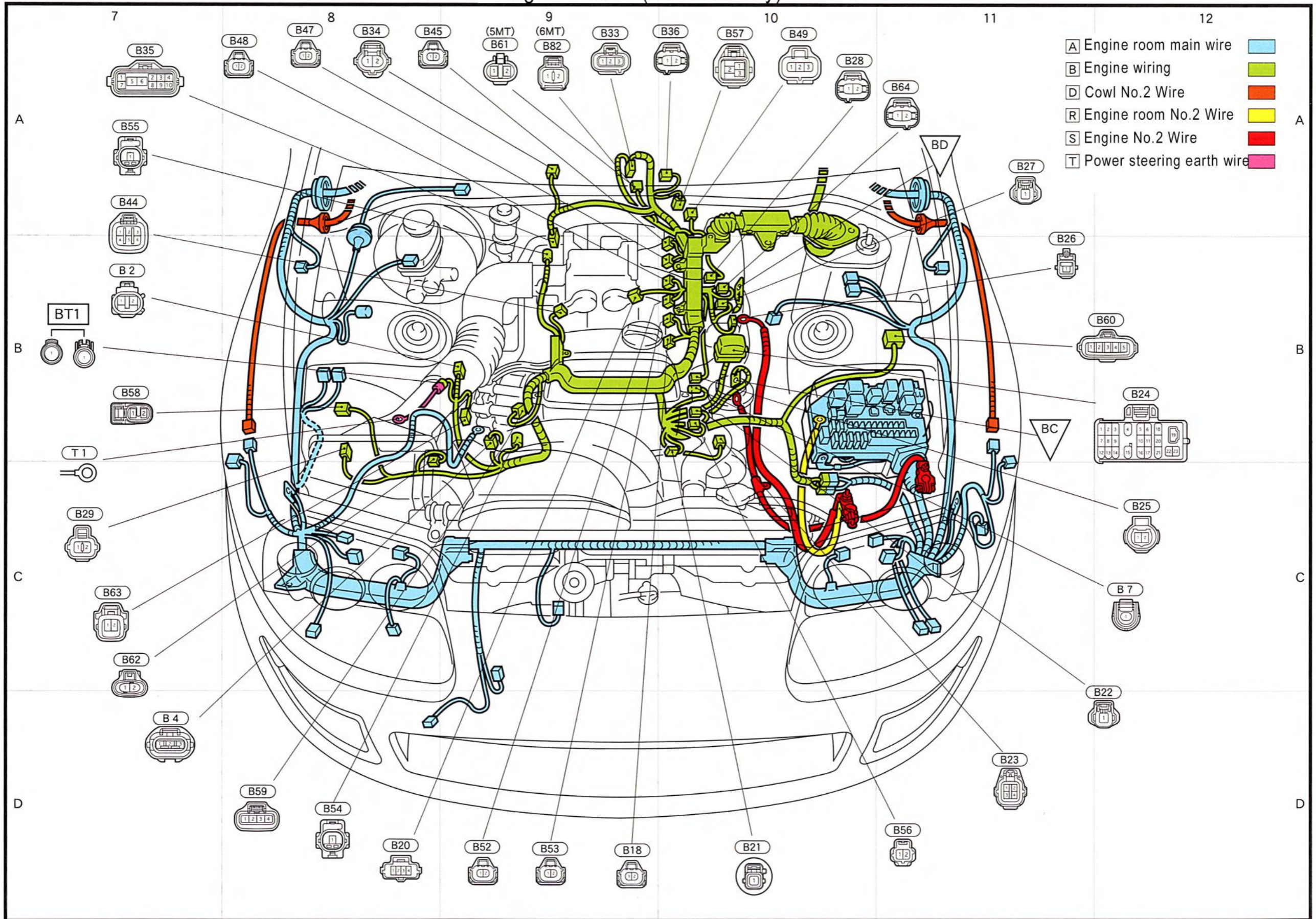

- A Engine room main wire █
- B Engine wiring █
- D Cowl No.2 Wire █
- R Engine room No.2 Wire █
- S Engine No.2 Wire █
- T Power steering earth wire █

- (B 2) B-7 Power steering solenoid
- (B 4) D-7 Alternator
- (B 7) C-12 Water temperature sender gauge
- (B18) D-9 Injector No.1
- (B20) D-8 Throttle position sensor
- (B21) D-10 Oil pressure switch
- (B22) D-12 Knock Sensor No.1
- (B23) D-11 Magnetic clutch and lock sensor
- (B24) B-12 Diagnosis connector
- (B25) C-12 Engine Sae oil level sensor (~ 96.4)
- (B26) B-11 Starter
- (B27) A-11 Knock Sensor No.2
- (B28) A-10 VSV (Canister purge)
- (B29) C-7 Condenser (radio)
- (B33) A-9 Meter speed sensor
- (B34) A-8 A/T oil temperature sensor
- (B35) A-7 Park-Neutral switch (A/T)
- (B36) A-10 A/T Rotation sensor
- (B44) A-7 ISCV
- (B45) A-8 Injector
- (B47) A-8 Injector
- (B48) A-8 Injector
- (B49) A-10 Vacuum sensor
- (B52) D-9 Injector
- (B53) D-9 Injector
- (B54) D-8 O₂ sensor No.1
- (B55) A-7 O₂ sensor No.2
- (B56) D-11 Water temperature sensor
- (B57) A-10 ECT solenoid
- (B58) B-7 Ignition coil
- (B59) D-8 Distributor
- (B60) B-12 Igniter
- (B61) A-9 Rear lamp switch (5M / T)
- (B62) C-7 Intake air temperature sensor
- (B63) C-7 Power steering pressure switch
- (B64) A-11 VSV (Variable intake control)
- (B82) A-9 Rear lamp switch (6M / T)
- (T 1) B-7 Steering gear box earth (~, 94.8)

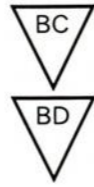

B-11 Intake manifold front ground

A-11 Intake manifold rear ground

- BT1 B-7 Power steering and engine ground wire(~ 94.8)

Engine room (2JZ-GTE types)

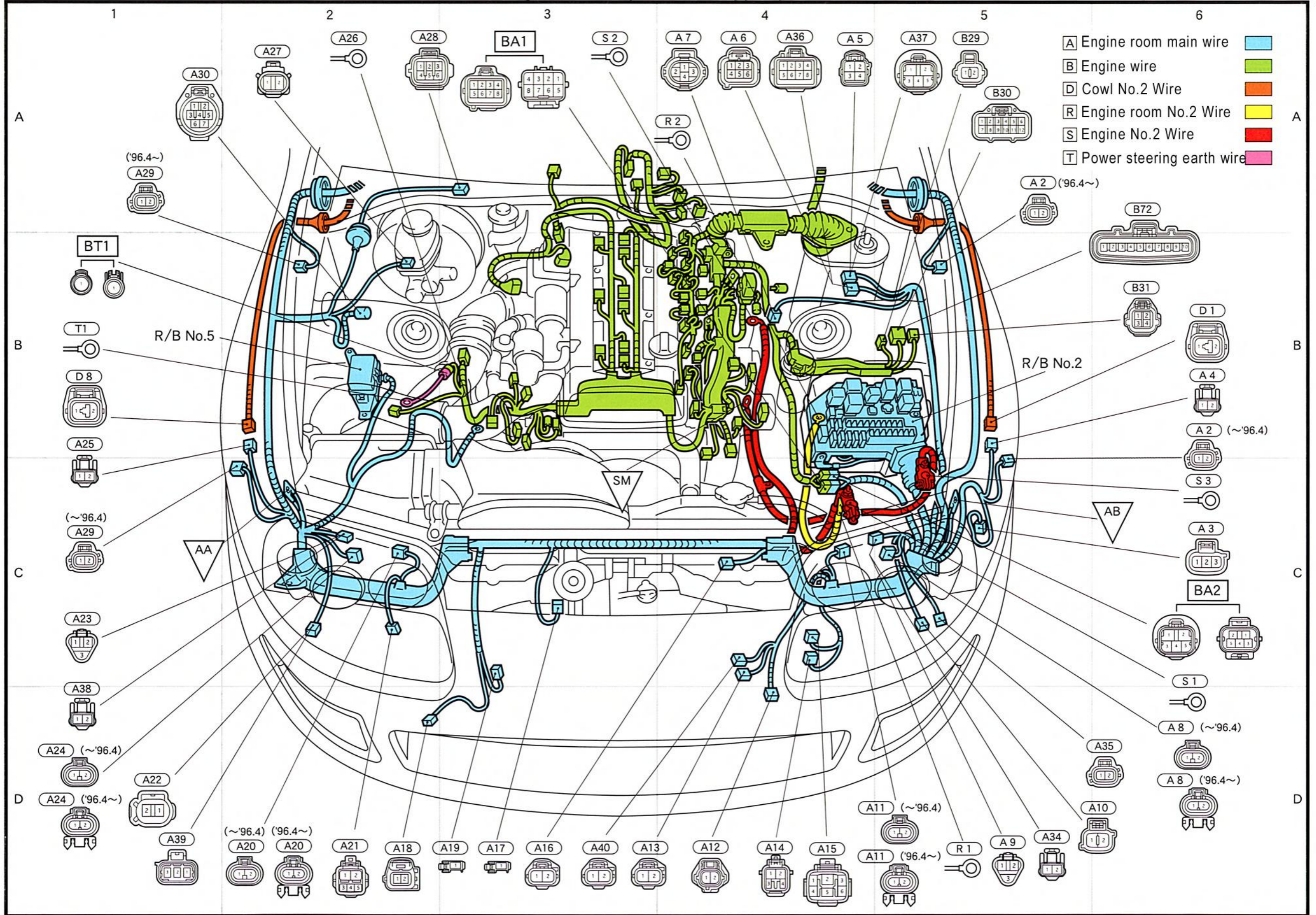

- A Engine room main wire
- B Engine wire
- D Cowl No.2 Wire
- R Engine room No.2 Wire
- S Engine No.2 Wire
- T Power steering earth wire

(A 2) A-5 Side turn LH (~, 96.4)
 (A 2) B-6 Side turn LH (96.4 ~)
 (A 3) C-6 Washer motor
 (A 4) B-6 ABS speed sensor FR. LH
 (A 5) A-5 ABS actuator ('96 .4)
 (A 6) A-4 ABS actuator one ter (~, 96.4)
 (A 7) A-4 Pressure switch (high and low pressure side switch and air conditioning in the pressure side switch)
 (A 8) D-6 Head lamp LH (LO)
 (A 9) D-5 Fog lamp LH & clearance lamp LH (~ 96.4)
 (A10) D-6 Front turn LH
 (A11) D-5 Head lamp LH (HI)
 (A12) D-4 Water temperature switch (condenser fan)
 (A13) D-3 Radiator fan motor
 (A14) D-4 Fan relay No_1
 (A15) D-4 Fan relay No_2
 (A16) D-3 Condenser fan motor
 (A17) D-3 Horn LH
 (A18) D-2 Ambient temperature sensor
 (A19) D-3 Horn RH
 (A20) D-2 Head lamp RH (IH)
 (A21) D-2 Spoiler motor
 (A22) D-1 Front turn RH (~, 96.4)
 (A23) C-1 Fog lamp RH & clearance lamp RH + (~, 96.4)
 (A24) D-1 Head lamp RH (LO)
 (A25) B-1 ABS speed sensor FR. RH
 (A26) A-2 Alternator
 (A27) A-2 Brake level warning switch
 (A28) A-2 Wiper motor
 (A29) C-1 Side turn RH (~, 96_4)
 (A29) A-1 Side turn RH (96.4 ~)
 (A30) A-1 Cruise control actuator (~ '95_5)
 (A34) D-5 Fog lamp LH (96.4 ~)
 (A35) D-6 Clearance lamp LH (96.4 ~)
 (A36) A-4 ABS actuator (96.4 ~)
 (A37) A-5 ABS actuator (96.4 ~)
 (A38) D-1 Fog lamp RH (96.4 ~)
 (A39) D-1 Front turn RH & clearance lamp RH + ('96 .4 -
 (A40) D-3 Cooling fan motor ('96 .4 ~)
 (B29) A-5 Condenser (radio)
 (B30) A-5 Igniter (~ '97 .8)

(B31) B-6 Igniter (~ 97.8)
 (B72) A-6 Igniter (97.8 ~)
 (D 1) B-6 Airbag sensor LH (~ '96 .4)
 (D 8) B-1 Airbag sensor RH (~ '96 .4)
 (R 1) D-5 Battery (+)
 (R 2) A-3 FL Horta
 (S 1) C-6 Battery (+)
 (S 2) A-3 Starter
 (S 3) B-6 Battery (-)
 (T 1) B-1 Steering gear box earth (~ 94.8)
 (BA1) A-3 } Engine room main wire and the engine wiring
 (BA2) C-6 }
 (BT1) B-1 Power steering and engine ground wire wire (~, 94.8)

(AA) C-1 Right fender apron earth
 (AB) C-5 Left fender apron earth
 (SM) C-3 Engine block ground

Engine room (2JZ-GTE body)

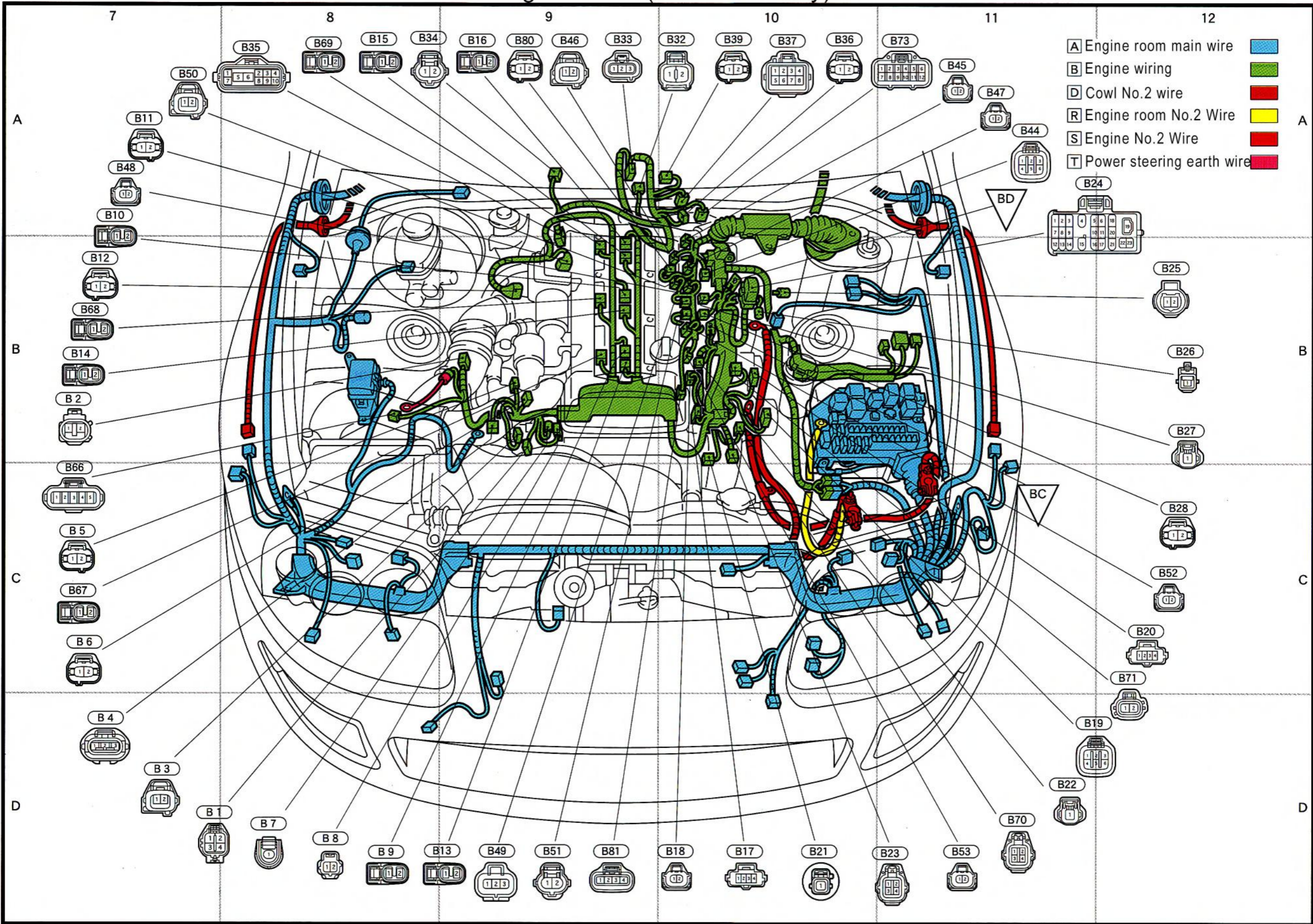

- A Engine room main wire
- B Engine wiring
- D Cowl No.2 wire
- R Engine room No.2 Wire
- S Engine No.2 Wire
- T Power steering earth wire

- (B 1) D-7 Sensor
- (B 2) B-7 Power steering solenoid
- (B 3) D-7 Engine speed sensor
- (B 4) D-7 Alternator
- (B 5) C-7 VSV (Exhaust control valve)
- (B 6) C-7 VSV (Wastegate)
- (B 7) D-8 Water temperature gauge sender
- (B 8) D-8 Water temperature sensor
- (B 9) D-8 Ignition coil No.2 (~, 97.8)
- (B10) A-7 Ignition coil No.4 (~, 97.8)
- (B11) A-7 VSV (Intake control valve)
- (B12) B-7 VSV (Exhaust bypass valve)
- (B13) D-9 Ignition coil No.1 (~, 97.8)
- (B14) B-7 Ignition coil No.3 (~, 97.8)
- (B15) A-8 Ignition coil No.5 (~, 97.8)
- (B16) A-9 Ignition coil No.6 (~, 97.8)
- (B17) D-10 Sub-throttle position sensor (~ '97 .8)
- (B18) D-10 Injector No.1
- (B19) D-12 Throttle valve motor (~ '97 .8)
- (B20) C-12 Throttle position sensor
- (B21) D-10 Oil pressure switch
- (B22) D-11 Knock Sensor No.1
- (B23) D-11 Magnetic clutch and lock sensor
- (B24) A-11 Diagnosis connector
- (B25) B-12 Engine oil level sensor
- (B26) B-12 Starter
- (B27) B-12 Knock Sensor No.2
- (B28) C-12 VSV (Canister purge)
- (B32) A-10 Backup lamp switch (M / T)
- (B33) A-9 Meter speed sensor (~ '97 .8)
- (B34) A-8 A / T oil temperature sensor (~ '97 .8)
- (B35) A-8 Neutral start switch (A / T)
- (B36) A-10 A/T Rotation sensor
- (B37) A-10 ECT solenoid (~, 97.8)
- (B39) A-10 O / D direct clutch speed sensor
- (B44) A-11 ISCV (~ .97.8)
- (B45) A-11 Injector No.6
- (B46) A-9 Cam position sensor RH
- (B47) A-11 Injector No.5
- (B48) A-7 Injector No.4
- (B49) D-9 Vacuum sensor

- (B50) A-7 Cam position sensor LH (~ 97.8)
- (B51) D-9 Intake air temperature sensor (~ '97 .8)
- (B52) C-12 Injector No.3
- (B53) D-11 Injector No.2
- (B66) C-7 Air flow meter (97.8 ~)
- (B67) C-7 Ignition coil No.1 (97.8 ~)
- (B68) B-7 Ignition coil No.2 (97.8 ~)
- (B69) A-8 Ignition coil No.3 (97.8 ~)
- (B70) D-11 Throttle valve motor (97.8 ~)
- (B71) C-12 VVT solenoid (97.8 ~)
- (B73) A-11 ECT solenoid (97.8 ~)
- (B80) A-9 VSV (fuel pressure control) (97.8 ~)
- (B81) D-9 Accelerator sensor (97.8 ~)



C-11 Intake manifold front ground



A-11 Intake manifold rear ground

Instrument panel (left side)

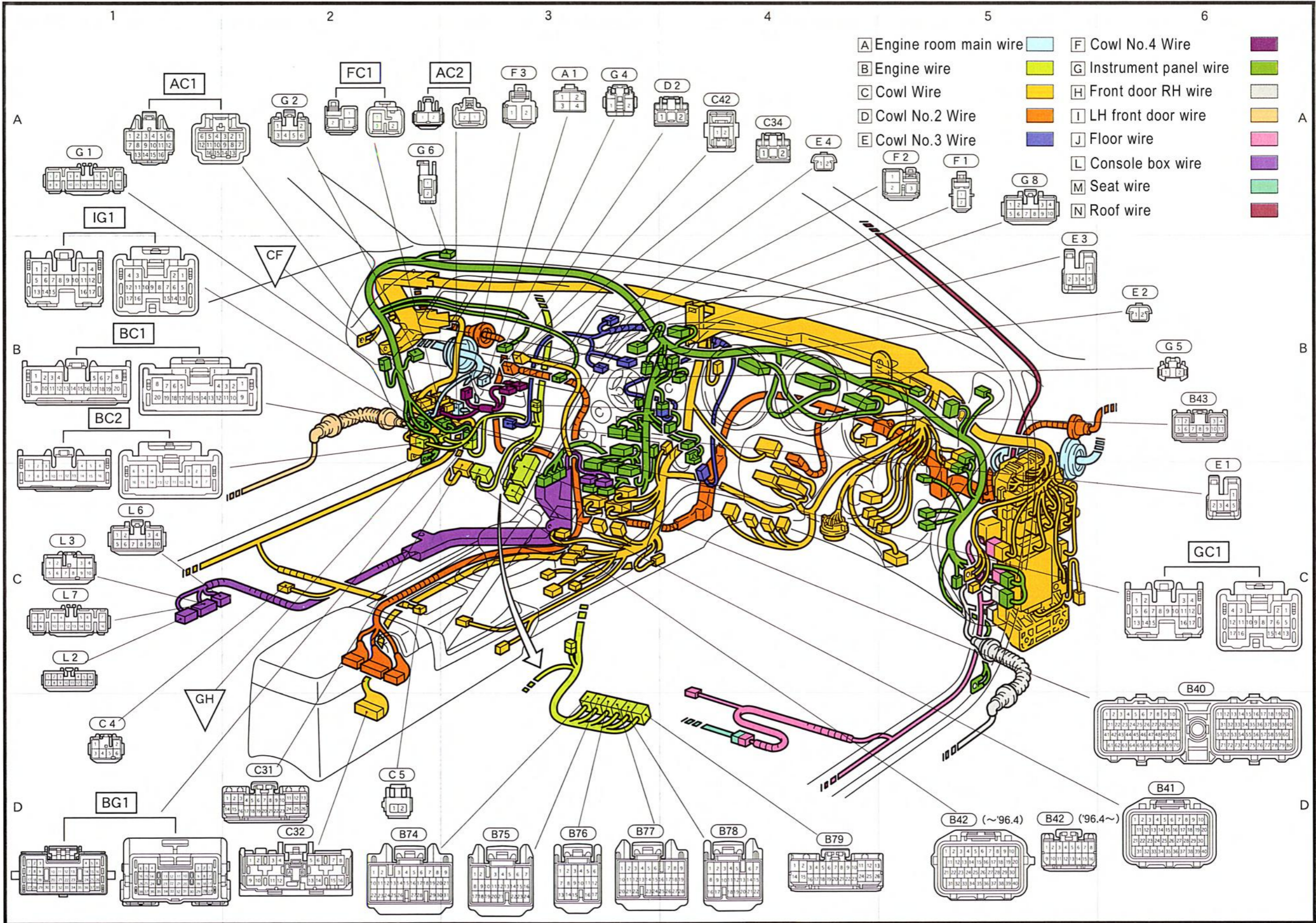

- | | | |
|-------------------------|-------------------------|--|
| A Engine room main wire | F Cowl No.4 Wire | |
| B Engine wire | G Instrument panel wire | |
| C Cowl Wire | H Front door RH wire | |
| D Cowl No.2 Wire | I LH front door wire | |
| E Cowl No.3 Wire | J Floor wire | |
| | L Console box wire | |
| | M Seat wire | |
| | N Roof wire | |

A 1	A-3	Telephone service connector ('96 .4)
B40	C-6	Engine control computer
B41	D-6	Engine control computer
B42	D-5	Throttle control computer (2JZ-GTE) (~, 97.8)
B43	B-6	J / C (Ground No.1)
B74	D-2	Engine control computer (2JZ-GTE) (97.8 ~)
B75	D-3	Engine control computer (2JZ-GTE) (97.8 ~)
B76	D-3	Engine control computer (2JZ-GTE) (97.8 ~)
B77	D-3	Engine control computer (2JZ-GTE) (97.8 ~)
B78	D-4	Engine control computer (2JZ-GTE) (97.8 ~)
B79	D-4	Engine control computer (2JZ-GTE) (97.8 ~)
C 4	C-1	Stereo power amplifier
C 5	D-2	Buckle switch LH
C31	D-2	Throttle control computer (2JZ-GTE) (96.4 ~, 97.8)
C32	D-2	Center airbag sensor (96.4 ~)
C34	A-4	Airbag LH (96.4 ~, 97.8)
C42	A-4	Airbag LH (97.8 ~)
D 2	A-4	Airbag LH (~, 96.4)
E 1	C-6	Inside and outside air - damper switching servo motor
E 2	B-6	After evaporation sensor
E 3	B-5	Air mix damper switching servo motor
E 4	A-4	Water temperature sensor
F 1	A-5	Blower control relay
F 2	A-5	Blower control relay
F 3	A-3	Blower motor
G 1	A-1	Door control relay
G 2	A-2	Power steering computer
G 4	A-3	Glove box lamp switch
G 5	B-6	Glove box lamp
G 6	A-2	Tweeter LH
G 8	A-5	Hazard switch
L 2	C-1	Stereo power amplifier
L 3	C-1	Stereo power amplifier (live sound system) (~ 94.8)
L 6	C-1	Stereo power amplifier (super live sound system)
L 7	C-1	Stereo power amplifier (super live sound system)

AC1	A-1	} Engine room main wire to cowl wire
AC2	A-3	
BC1	B-1	} Engine wire to cowl wire
BC2	B-1	
BG1	D-1	Engine wire to the instrument panel wire
FC1	A-2	Cowl No.4 wire to cowl wire
GC1	C-6	Instrument panel wire to cowl wire
IG1	A-1	Front door LH wire to the instrument panel wire

CF	B-2	Left side cowl on ground
GH	D-1	Left cowl side under ground

Instrument panel (center)

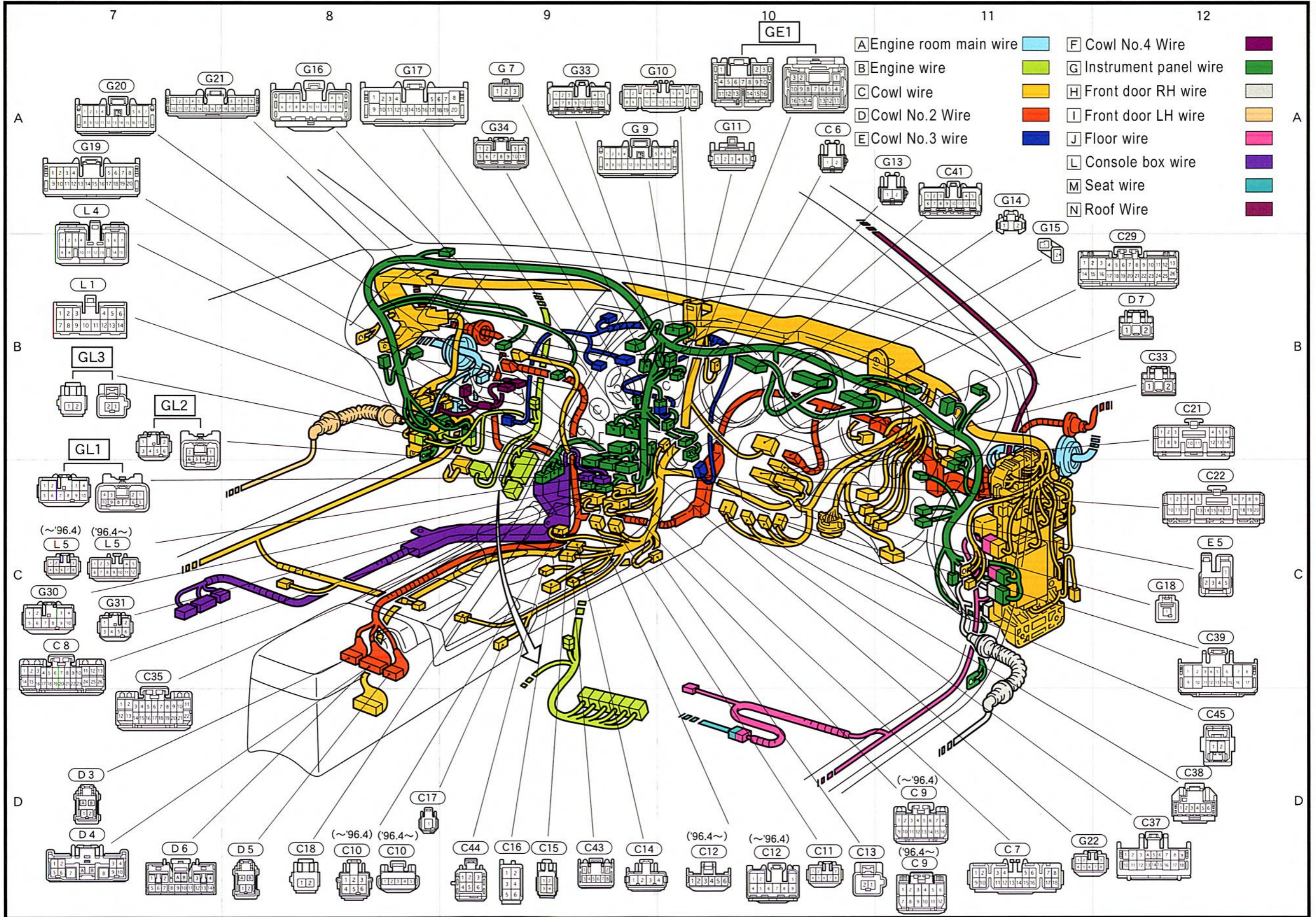

C 6 A-10 Clutch switch (M / T) (-95.5)
 C 7 D-11 Spoiler control computer
 C 8 C-7 ABS computer
 C 9 D-11 ABS computer
 C10 D-8 ABS Deceleration sensor
 C11 D-10 Spoiler control switch
 C12 D-10 Slip control off switch
 C13 D-10 Exhaust gas temperature sensor (~ '97 .8)
 C14 D-9 Selector position switch
 C15 D-9 O / D main switch (2JZ-GTE) (~, 97.8)
 C16 D-9 Shift lock control relay
 C17 D-8 Parking brake switch
 C18 D-8 Ashtray lighting
 C21 B-12 Combination switch (~ '97 .8)
 C22 C-12 Combination switch (~ '97 .8)
 C29 B-12 Cruise control computer (~, 95.5)
 C33 B-12 Airbag RH (96.4 ~ '97 .8)
 C35 C-7 ABS computer (except S-ABS) (96.4 ~)
 C37 D-12 Combination switch (97.8 ~)
 C38 D-12 Combination switch (97.8 ~)
 C39 C-12 Combination switch (97.8 ~)
 C41 A-11 J/C No.2 (97.8~)
 C43 D-9 Shift lock control relay (97.8 ~)
 C44 D-9 Shift select switch (97.8 ~)
 C45 D-12 Airbag RH (steering wheel pad) (97.8 ~)
 D 3 D-7 Center airbag sensor (no passenger) (~, 96.4)
 D 4 D-7 Center airbag sensor (no passenger) (~, 96.4)
 D 5 D-8 Center airbag sensor (no passenger) (~, 96.4)
 D 6 D-7 Center airbag sensor (with passenger) (~, 96.4)
 D 7 B-12 Airbag RH (~ .96.4)
 E 5 C-12 Mode switching damper servo motor
 G 7 A-9 Diode (idle-up)
 G 9 A-9 Tail lamp LH
 G10 A-10 J/C No.1
 G11 A-10 Clock
 G13 A-11 Indoor temperature sensor
 G14 A-11 Cigarette lighter lighting
 G15 A-11 Cigarette lighter
 G16 A-8 Air conditioner control switch
 G17 A-8 Air conditioner control switch

G18 C-12 Antenna amplifiers (~, 96.4)
 G19 A-7 Air conditioning computer
 G20 A-7 Air conditioning computer
 G21 A-7 Air conditioning computer
 G22 D-11 Auto-antenna relay
 G30 C-7 Radio & Stereo (6 speaker system)
 G31 C-7 Radio & Stereo (6 speaker system)
 G33 A-9 J/C No.3 ('97.8~)
 G34 A-9 J/C No.4 ('97.8~)
 L 1 B-7 Radio & Stereo (live sound system) (~, 94.8)
 L 4 A-7 Radio & Stereo (super live sound system)
 L 5 C-7 Radio & Stereo (super live sound system)

GE1 A-10 Instrument panel wire to cowl No.3 wire
 GL1 B-7
 GL2 B-7 } Instrument panel wire to wire console box
 GL3 B-7

Instrument panel (on the right)

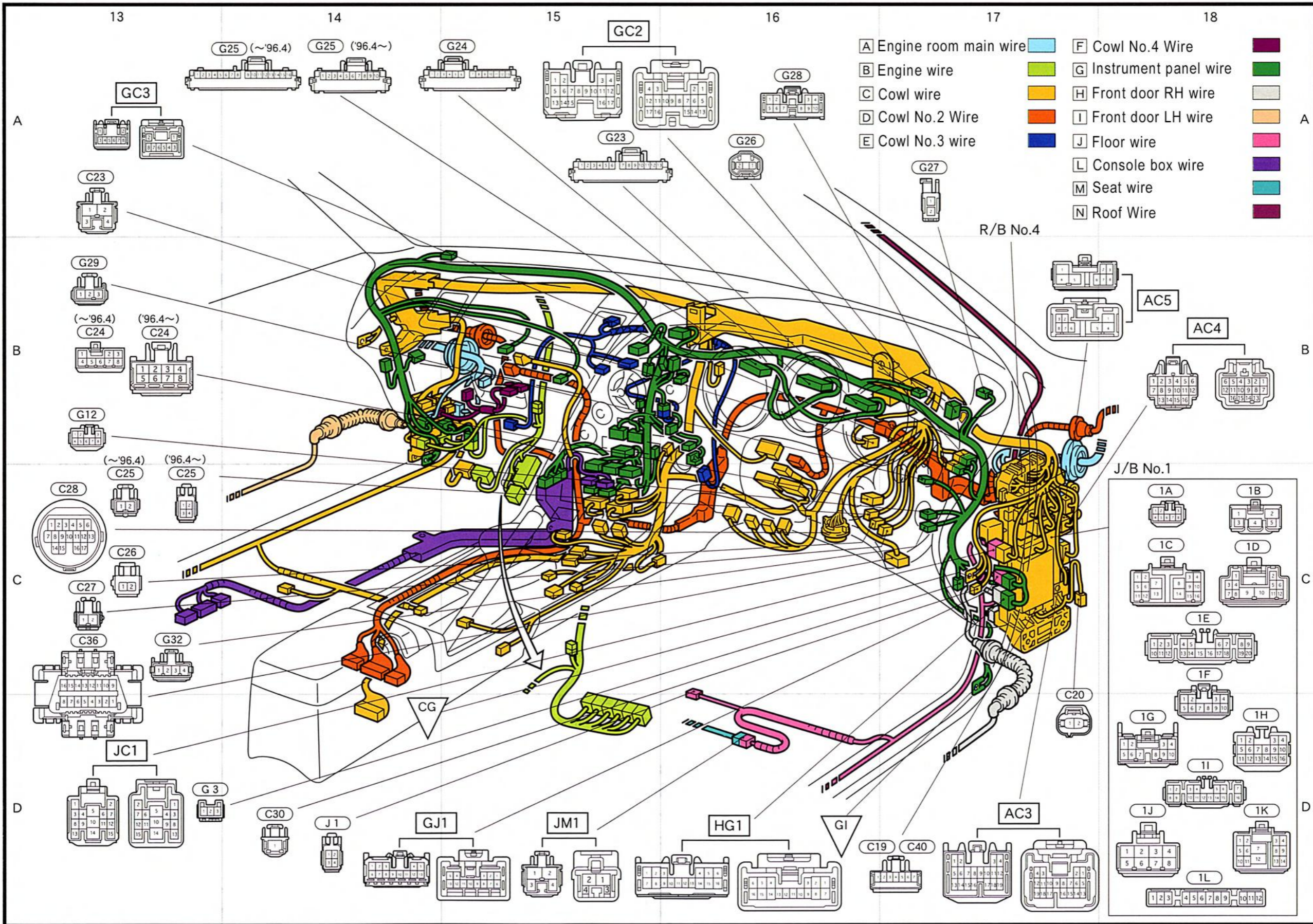

- (C19) D-17 Integration relay (~, 95.5)
- (C20) D-17 Kick-down switch (~ '97 .8)
- (C23) A-13 Stop lamp switch
- (C24) B-13 Ignition switch
- (C25) C-13 Key unlock warning switch & key interlock solenoid

- (C26) C-13 Key interlock solenoid (~'96 .4)
- (C27) C-13 Key cylinder lamp
- (C28) C-13 TDCL
- (C30) D-14 Noise filter (defogger)
- (C36) C-13 DLC3 (2JZ-GTE) (97.8~)
- (C40) D-17 Integration relay (97.8 ~)
- (G 3) D-13 Diode (interior lamp)
- (G12) B-13 Outer mirror switch
- (G23) A-15 Combination meter
- (G24) A-15 Combination meter
- (G25) A-14 Combination meter
- (G26) A-16 Solar radiation sensor
- (G27) A-17 Tweeter RH
- (G28) A-16 Tail light RH
- (G29) B-13 Rheostat
- (G32) C-13 Mirror folding switch (94.8 ~)
- (J 1) D-14 Buckle switch RH

- (AC3) D-17
- (AC4) B-18 } Engine room main wire to cowl wire
- (AC5) B-18 }
- (GC2) A-15 } Instrument panel wire to cowl wire
- (GC3) A-13 }
- (GJ1) D-14 Instrument panel wire to floor wire
- (HG1) D-16 Front door RH wire to the instrument panel wire
- (JC1) D-13 Floor wire to cowl wire
- (JM1) D-15 Floor wire to seat wire

- (CG) D-15 Right cowl side on earth
- (GI) D-16 Right cowl side under ground

- (1 A) C-18 } Engine room main wire to J / B No.1
- (1 B) C-18 }
- (1 C) C-18 Floor wire to J / B No.1
- (1 D) C-18 Front door RH wire to J / B No.1
- (1 E) C-18 Instrument panel wire to J / B No.1
- (1 F) C-18 Roof wire to J / B No.1
- (1 G) D-18 Cowl No_2 wire to J / B No.1 (~, 96.4)
- (1 G) D-18 Cowl wire to J / B No.1 (96.4 ~)
- (1 H) D-18
- (1 I) D-18 } Cowl wire to J / B No.1
- (1 J) D-18 }
- (1 K) D-18
- (1 L) D-18 Integration relay to J / B No.1

Body (No.1)

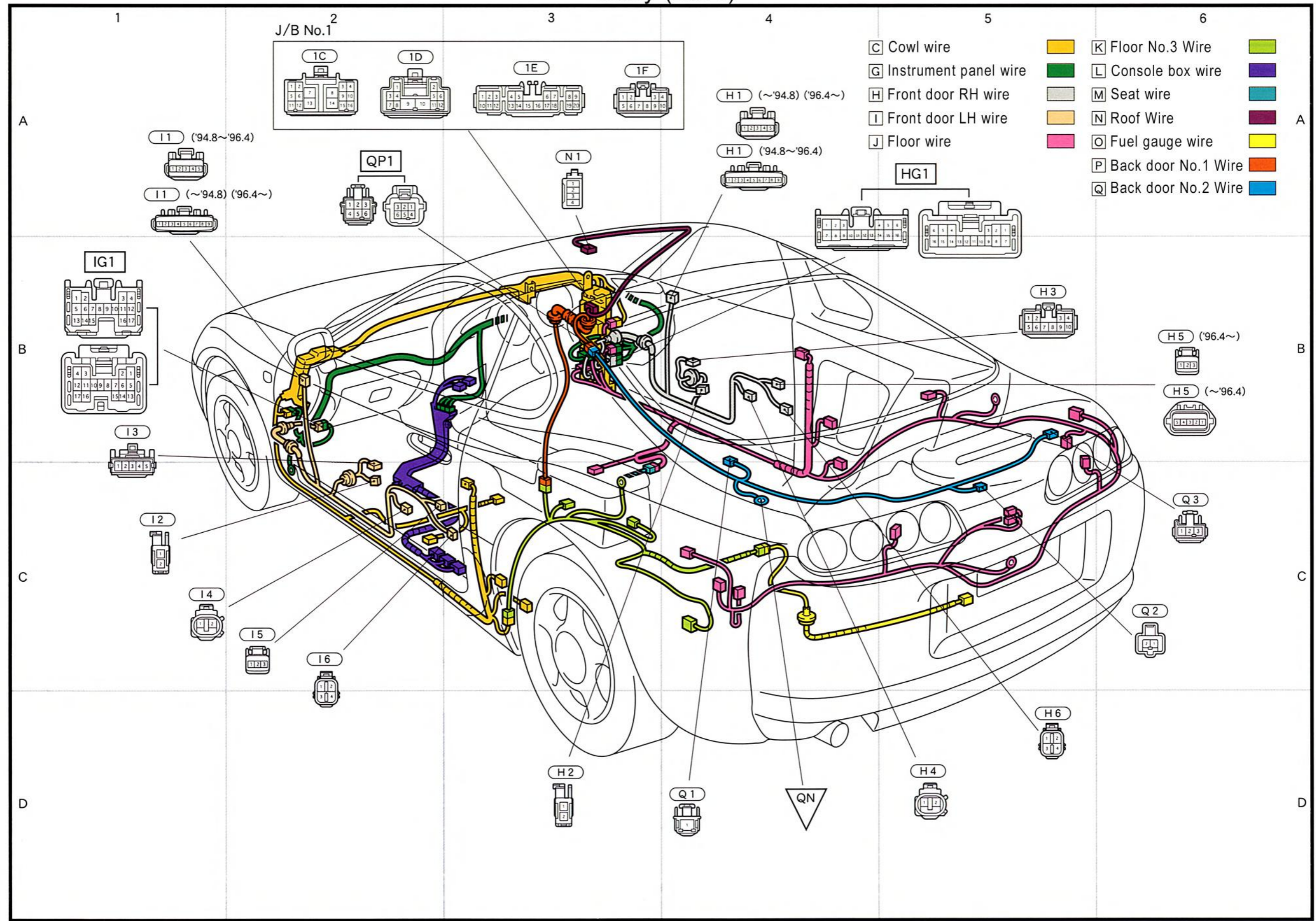

H1 A-4 Remote control actuator RH (door mirror) and mirror heater RH

H2 D-3 Front speakers RH

H3 B-5 Door control switch (power window master switch)

H4 D-5 Power window motor RH

H5 B-6 Door control switch RH (key interlock) & door key lighting

H6 D-5 Door control motor RH

I1 A-1 Remote control actuator LH (door mirror) and mirror heater LH

I2 C-1 Front speakers LH

I3 B-1 Power window switch LH

I4 C-1 Power window motor LH

I5 C-2 Door control switch LH (key interlock)

I6 C-2 Door control motor-LH

N1 A-3 Map lamp and room lamp

Q1 D-4 Noise filter (defogger)

Q2 C-6 Center stop lamp (LED)

Q3 C-6 Rear wiper motor and relay

1C A-2 Floor wire to J / B No.1

1D A-2 Front door RH wire to J / B No.1

1E A-3 Instrument panel wire to J / B No.1

1F A-3 Roof wire to J / B No.1

HG1 A-5 Front door RH wire to the instrument panel wire

IG1 B-1 Front door LH wire to the instrument panel wire

QP1 A-2 Back door No.2 wire to wire back door No.1

QN D-4 Back door panel left earth

Body (No.2)

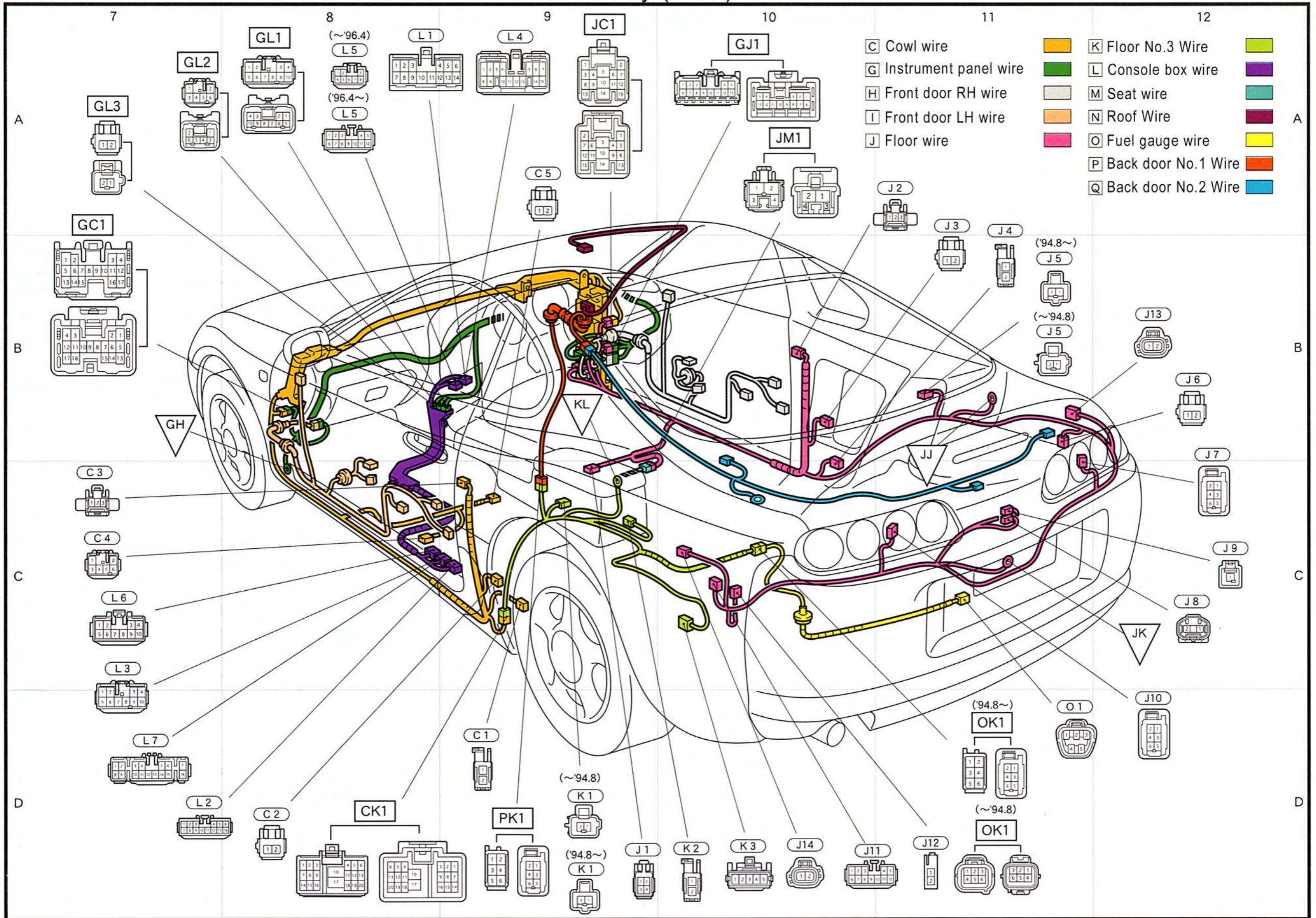

C1	D-9	LH rear speaker
C2	D-8	Lap belt solenoid LHd
C3	C-7	Courtesy switch LH
C4	C-7	Stereo power amplifier
C5	A-9	Buckle switch LH
J1	D-9	Buckle switch RH
J2	A-11	Courtesy switch RH
J3	A-11	Lap belt solenoid RH
J4	A-11	RH rear speakers
J5	B-11	ABS speed sensor RR • RH
J6	B-12	Antenna motor
J7	B-12	Rear combination lamp RH
J8	C-12	License plate lamp
J9	C-12	Luggage room lamp switch
J10	D-12	Rear combination lamp LH
J11	D-10	Lamp failure ECU
J12	D-11	Luggage room lamp
J13	B-12	Rear side turn RH (96.4 ~)
J14	D-10	Rear side turn LH (96.4 ~)
K1	D-9	ABS speed sensor RR • LH
K2	D-10	Woofer speaker
K3	D-10	Fuel pump ECU
L1	A-8	Radio & Stereo (live sound system) (~ '94 .8)
L2	D-7	Stereo power amplifier
L3	C-7	Stereo power amplifier (live sound system) (~ '94 .8)
L4	A-9	Radio & Stereo (super live sound system)
L5	A-8	Radio & Stereo (super live sound system)
L6	C-7	Stereo power amplifier (super live sound system)
L7	D-7	Stereo power amplifier (super live sound system)
O1	D-11	Fuel pump and fuel gauge sender

PK1 D-9 Backdoor No.1 wire to wire floor No.3

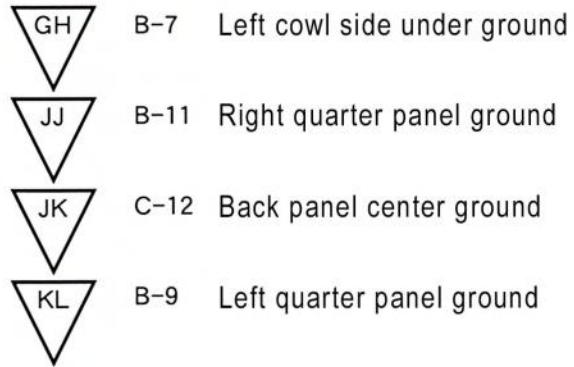

CK1	D-8	Cowl wire to floor wire No.3
GC1	A-7	Instrument panel wire to cowl wire
GJ1	A-10	Instrument panel wire to floor wire
GL1	A-8	Instrument panel wire to console box wire
GL2	A-7	
GL3	A-7	
JC1	A-9	Floor wire to cowl wire
JM1	A-10	Floor wire to seat wire
OK1	D-11	Fuel gauge wire to wire floor No.3

Seat

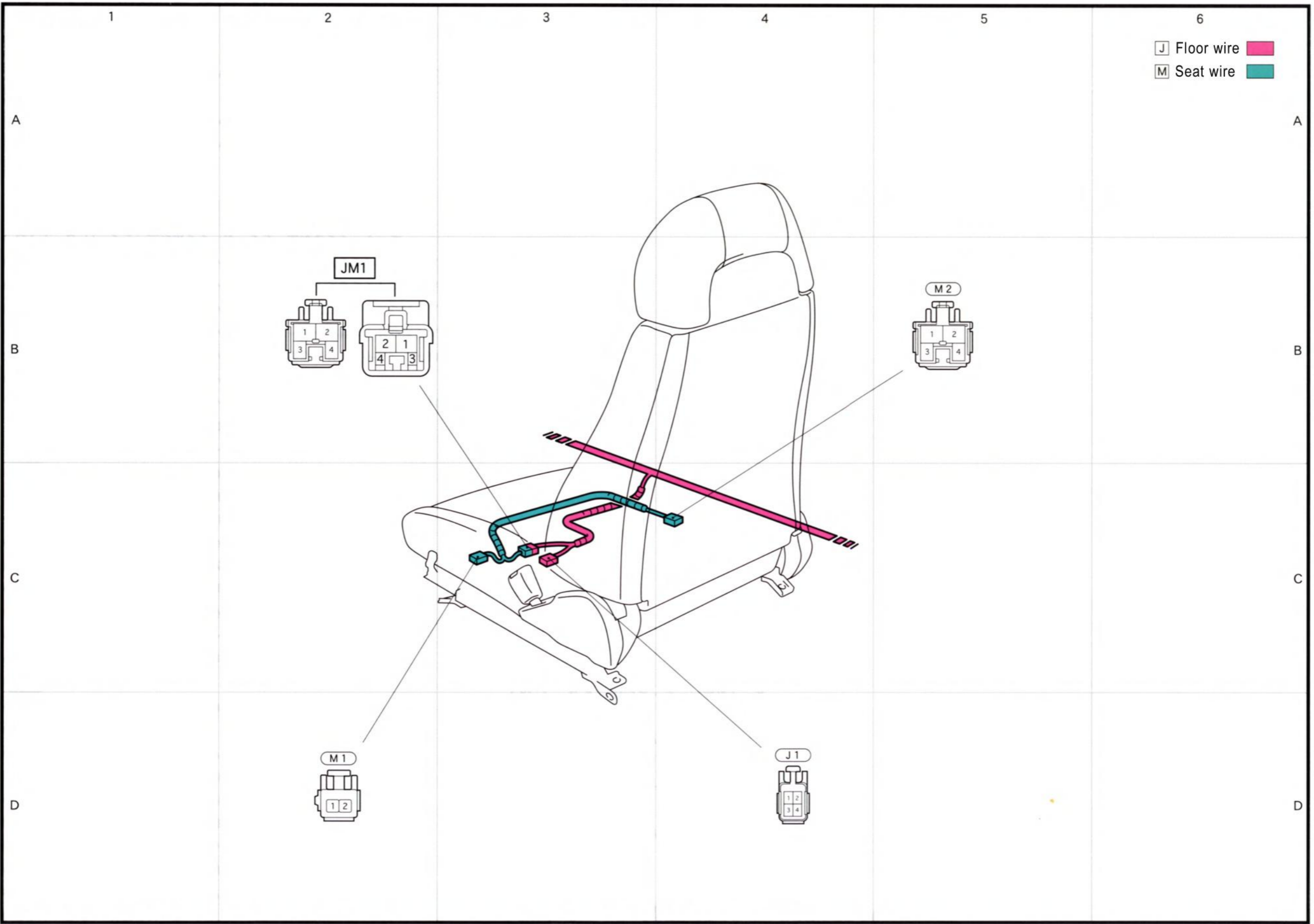

- J 1 D-4 Buckle switch RH
- M 1 D-2 Power seat motor
- M 2 B-5 Power seat switch

JM1 B-2 Floor wire to seat wire

Relay location

Engine room

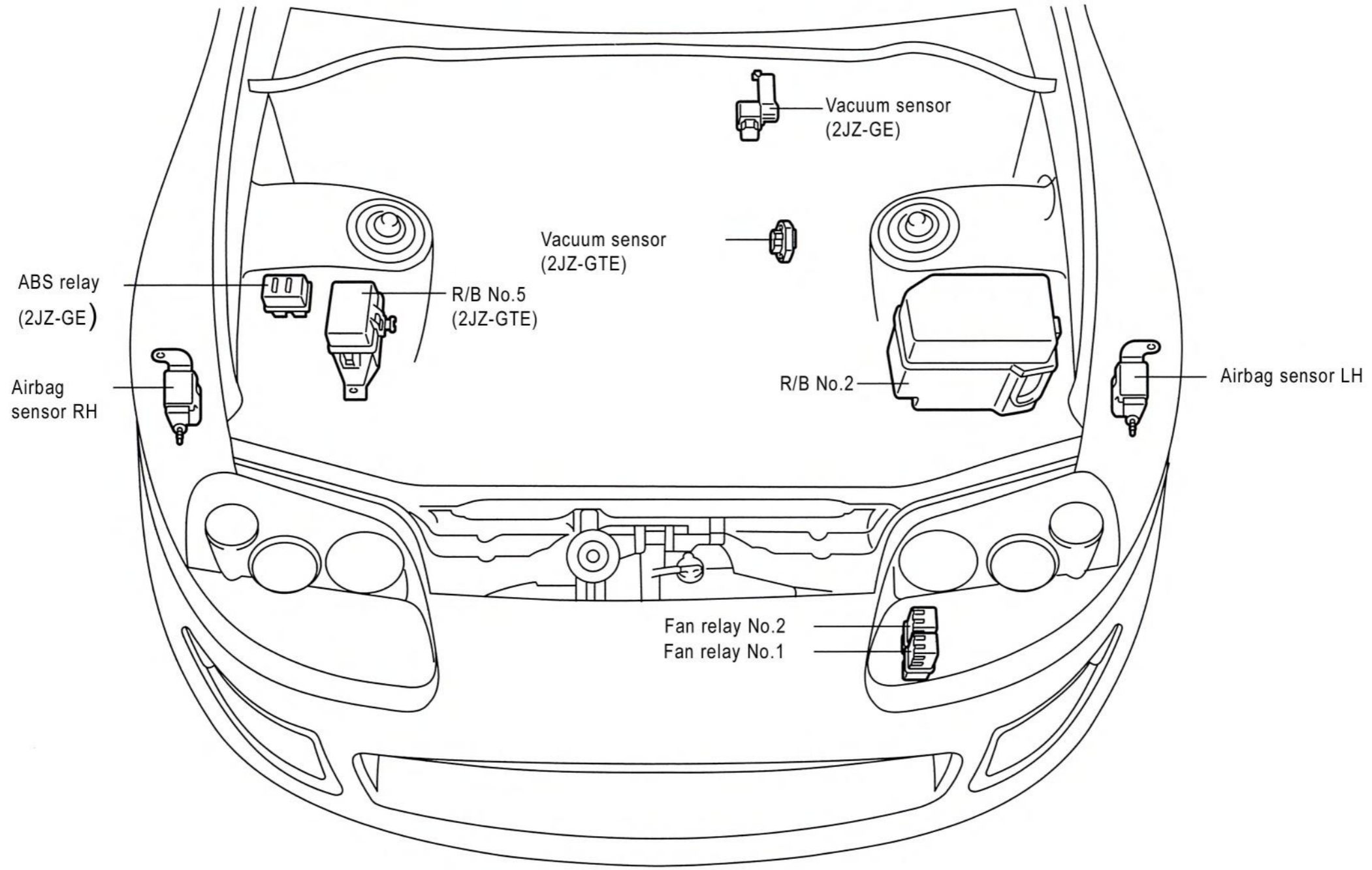

Instrument panel

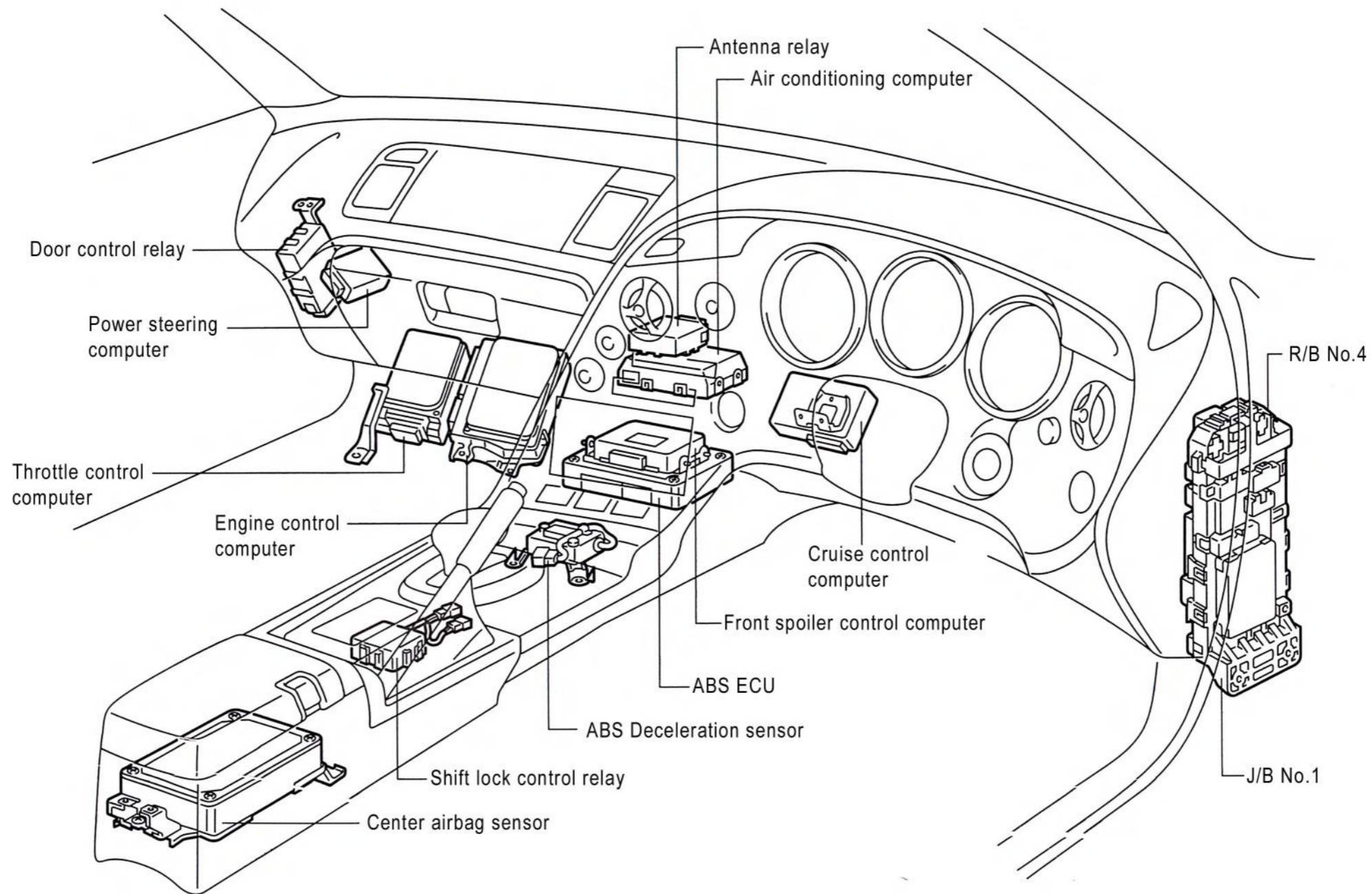

Body

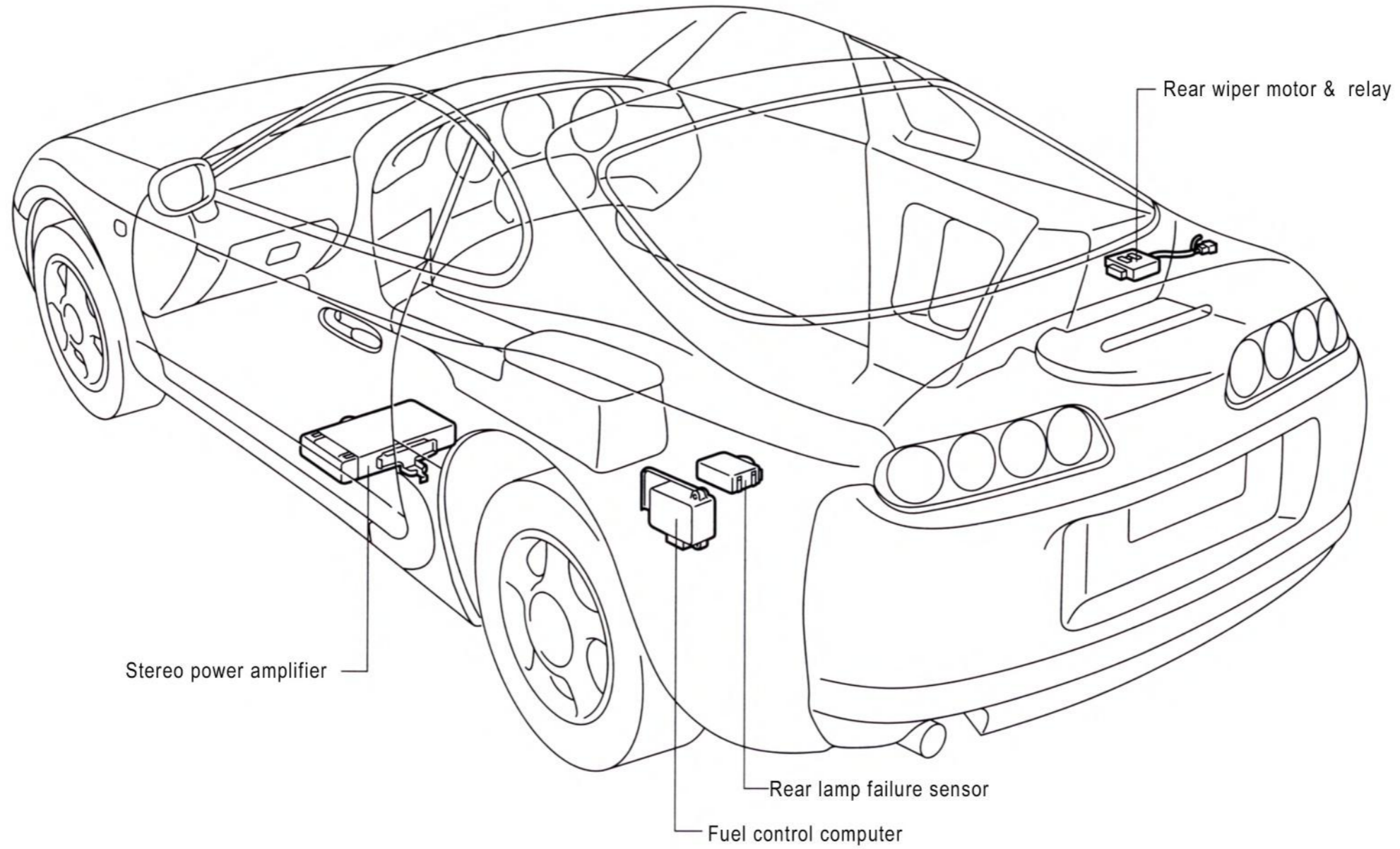

3 Wiring diagrams

Wiring diagrams

Power connection

Power source	3-2
Charging	3-5

Engine-connection

Starting and ignition	3-4
Engine control (2 J Z-G T E of ~ '9 7.8)	3-6
Engine control (2JZ-GE)	3-10
Engine contro (, 2 J Z-G T E 9 7.8 ~)	3-14

Chassis relationship

Shift lock (straight type).....	3-12
ECT ('~97.8 2JZ-GTE)	3-18
ECT ('97.8~ 2JZ-GTE)	3-20
ECT (2JZ-GE)	3-22
ABS (~ '9 6 • 4)	3-24
ABS ('9 6. 4 ~)	3-26
Shift indicator (97.8 ~ 2JZ - GTE)	3-27
TRC (~ '9 6 • 4)	3-28
TRC (, 96.4 ~ '97 .8).....	3-30
Air bag	3-32
Power steering	3-36
Shift lock (gated)	3-41
Shift indicator (, 97.8 ~ 2JZ-GTE).....	3-46

Body connection

Outer mirror.....	3-13
Warning forget to pull out the key	3-13
Front power seat	3-16
Power window	3-17
Active front spoiler	3-17
Door lock	3-23
Seat belt warning & Tension Reducer	3-29

Instrument panel around

Front wiper and washer	3-9
Wiper and washer	3-9
Horn	3-25
Audio (Super Live Sound System)	3-33
Combination meter (~ '9 6.4)	3-34
Antenna motor	3-37
Combination meter ('9 6.4 ~)	3-38
Audio (6 speaker system)	3-41
Audio (Live sound system - '9 4.8)	3-42
Clock	3-53

Light and Lamps

Head lamp.....	3-43
Turn signal and hazard.....	3-44
Prevent forgetting to turn off auto lamp	3-45
cut-and-light	
Fog lamp	3-45
Stop lamp	3-46
Tail lamp	3-47
Interior lamp	3-48
Illumination	3-49
Backup lamp	3-53

Air conditioning

Auto air conditioner.....	3-50
---------------------------	------

Other

Cruise control (~, 9 5.5).....	3-3
Rear window defogger and mirror heater ..	3-31
Ground	3-36
Telephone ('~96 .4)	3-37
Cigarette lighter.....	3-42
Power supply groundsystem over list	3-54

Power

*1:~'96.4 *3:~'97.8 2JZ-GTE *5:~'94.8
 *2:~'96.4~ *4:~'97.8~ 2JZ-GTE *6:~'94.8~

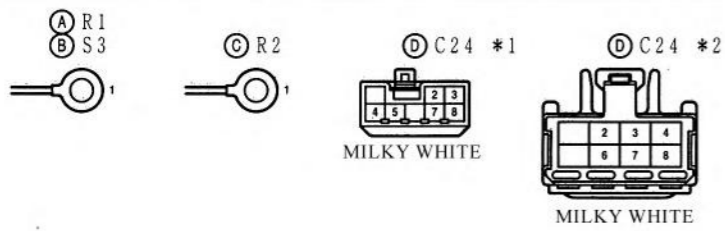
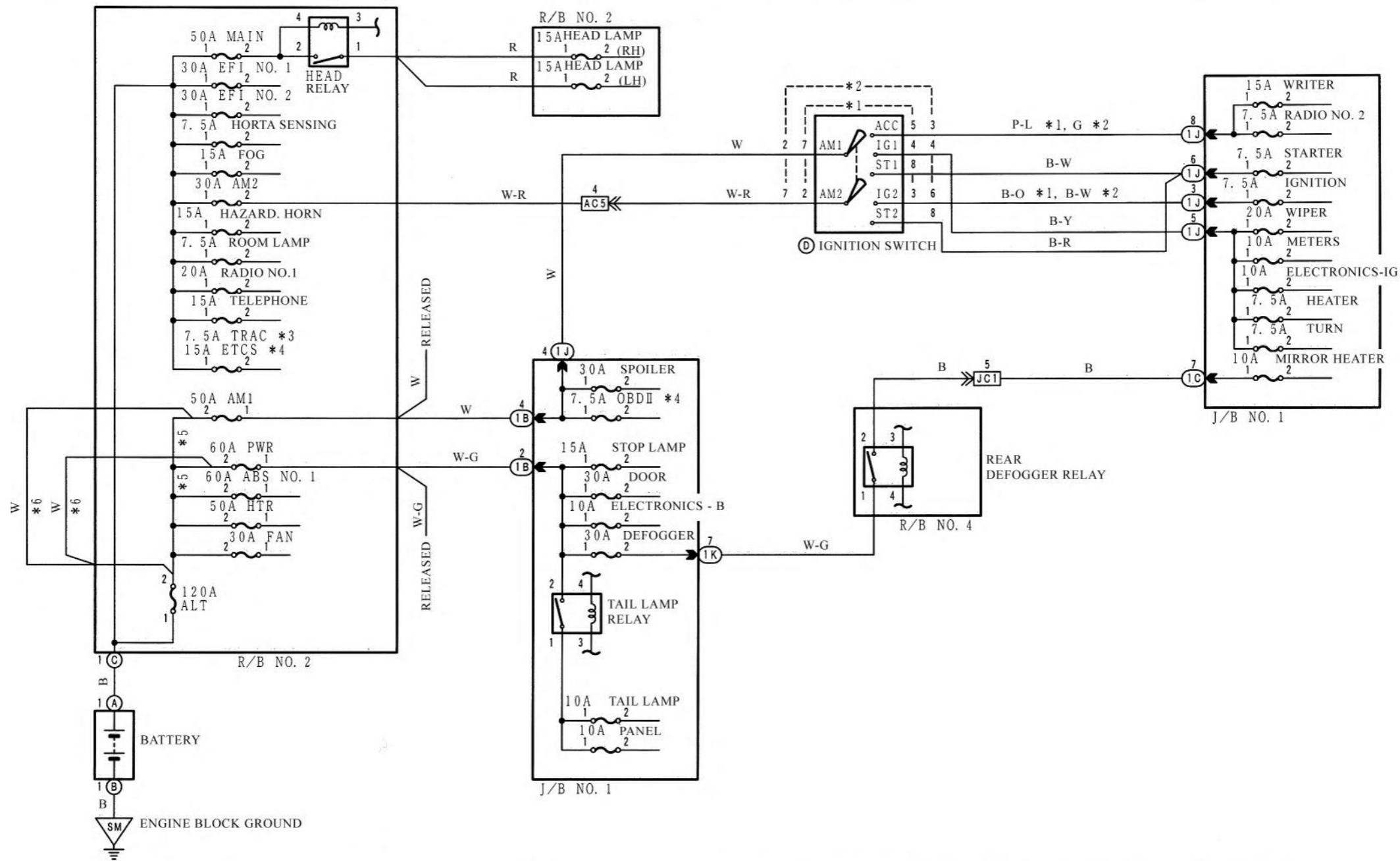

Cruise control (~ '9 5.5)

*1: ~ '94. 8
*2: '94. 8~

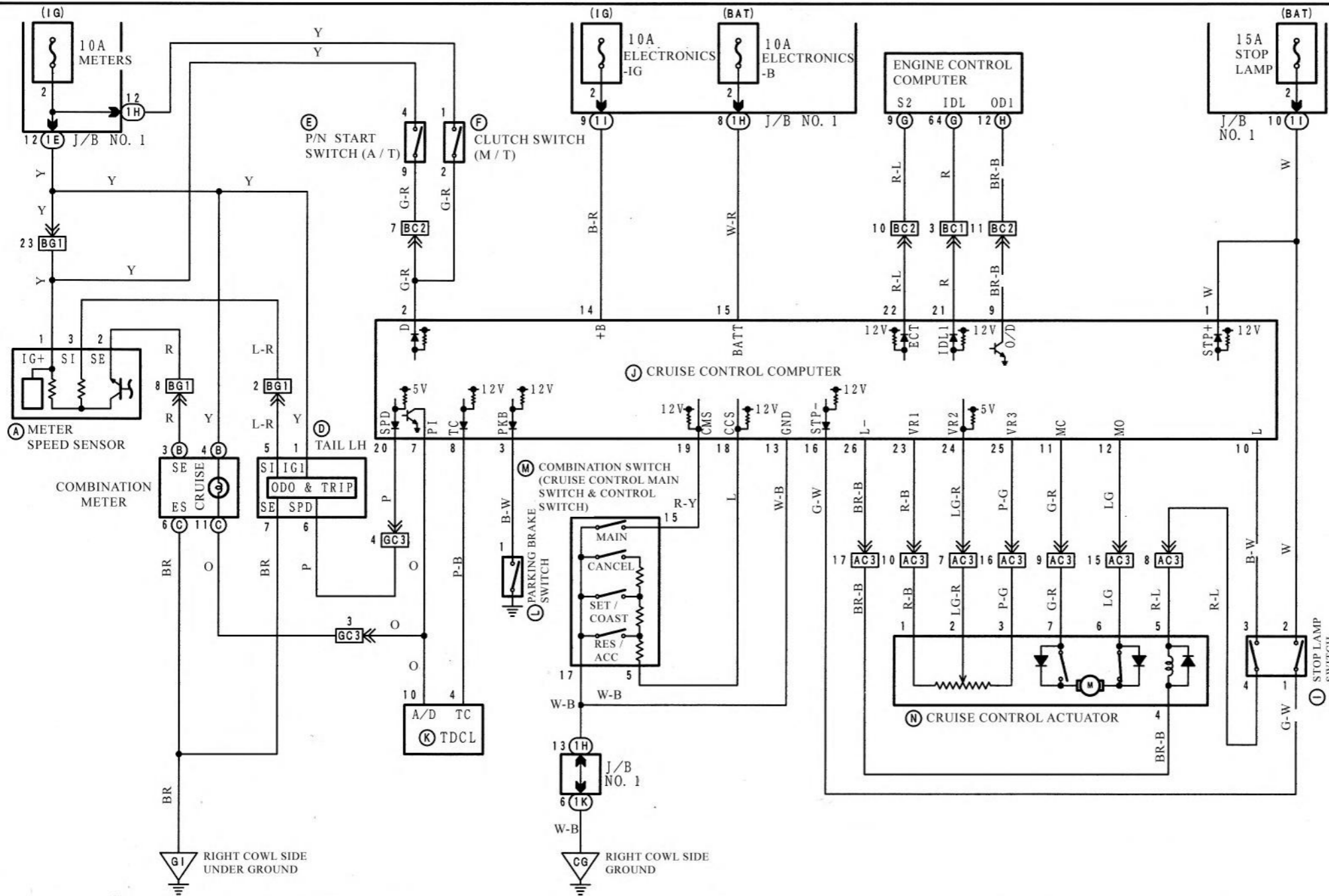

GRAY (A) B33 *1
BLACK (A) B33 *2

BLUE (B) G23

WHITE (C) G25

WHITE (D) G9

GRAY (E) B35

MILKY WHITE (F) C6

DARK GRAY (G) B40

DARK GRAY (H) B41

BLUE (I) C23

GREEN (J) C29

GRAY (K) C28 *1
DARK GRAY (K) C28 *2

(L) C17
MILKY WHITE

BLACK (M) C22

GRAY (N) A30

Starting & ignition

*1: 2JZ-GE *3: ~'96.4 *5: ~'97.8の2JZ-GTE *7: ~'94.4
 *2: 2JZ-GTE *4: '96.4~ *6: '97.8~の2JZ-GTE *8: '94.4~

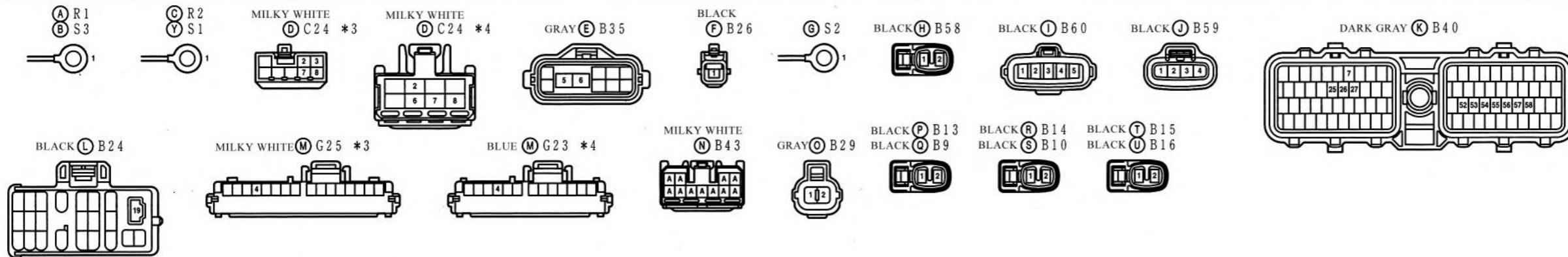
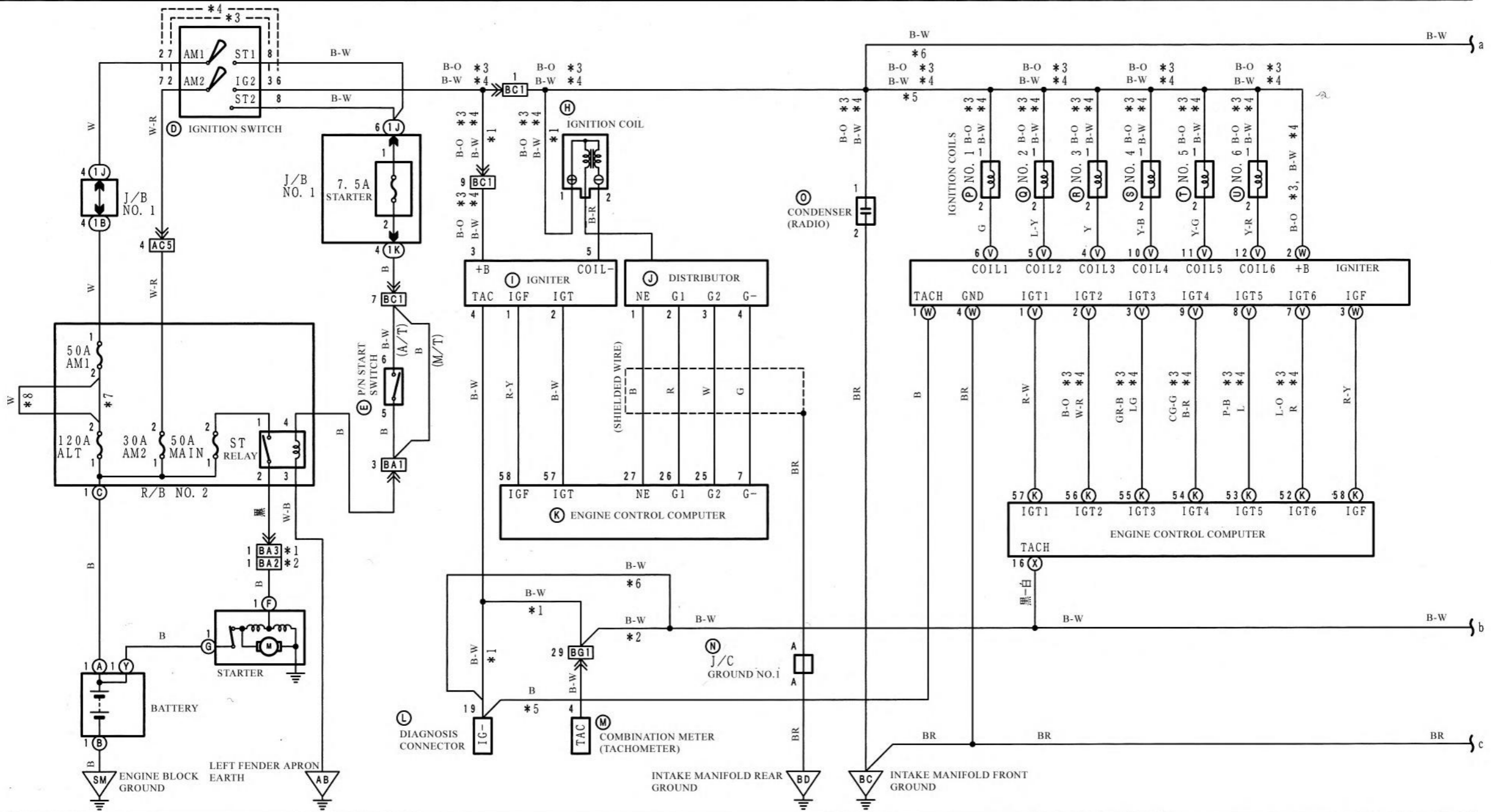

Starting and ignition

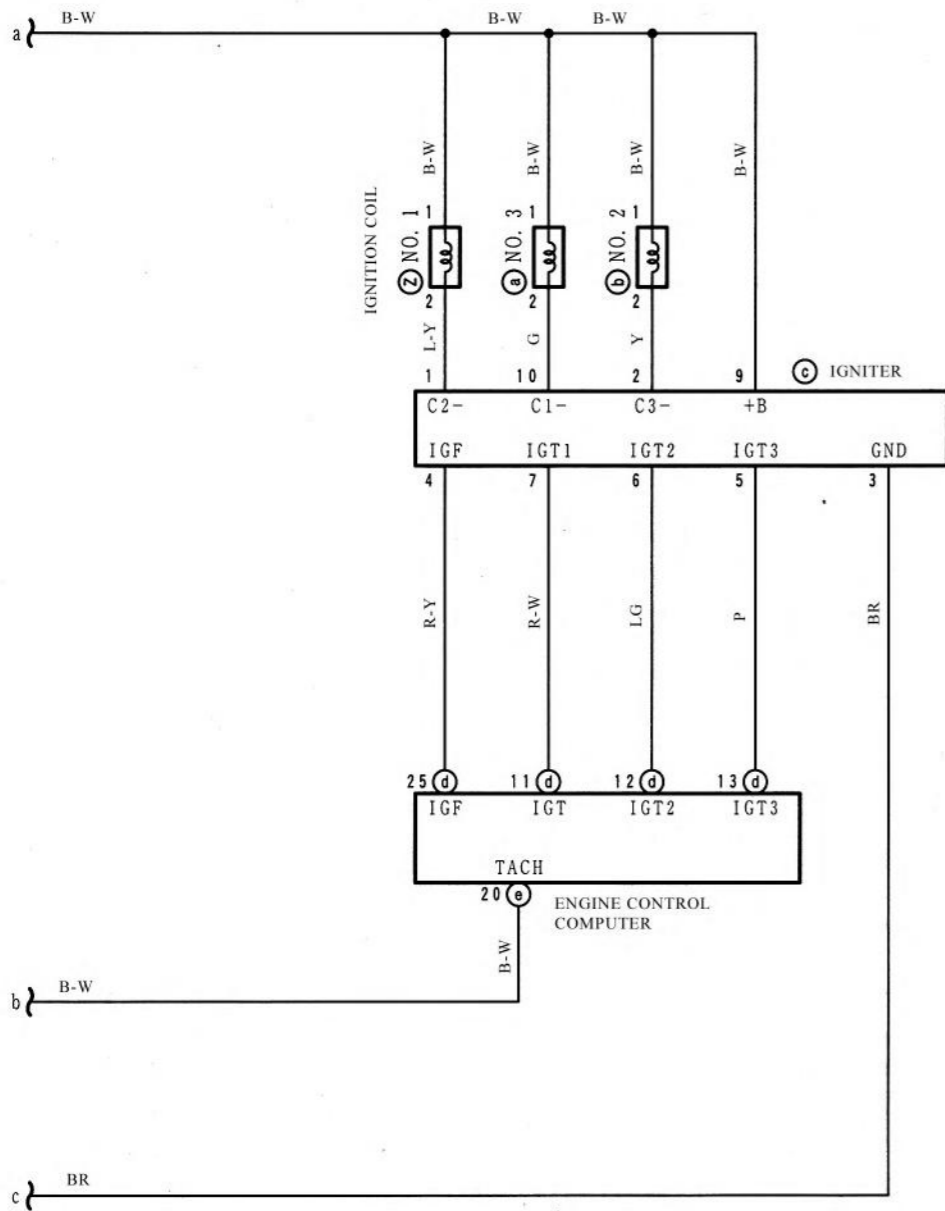

Charging

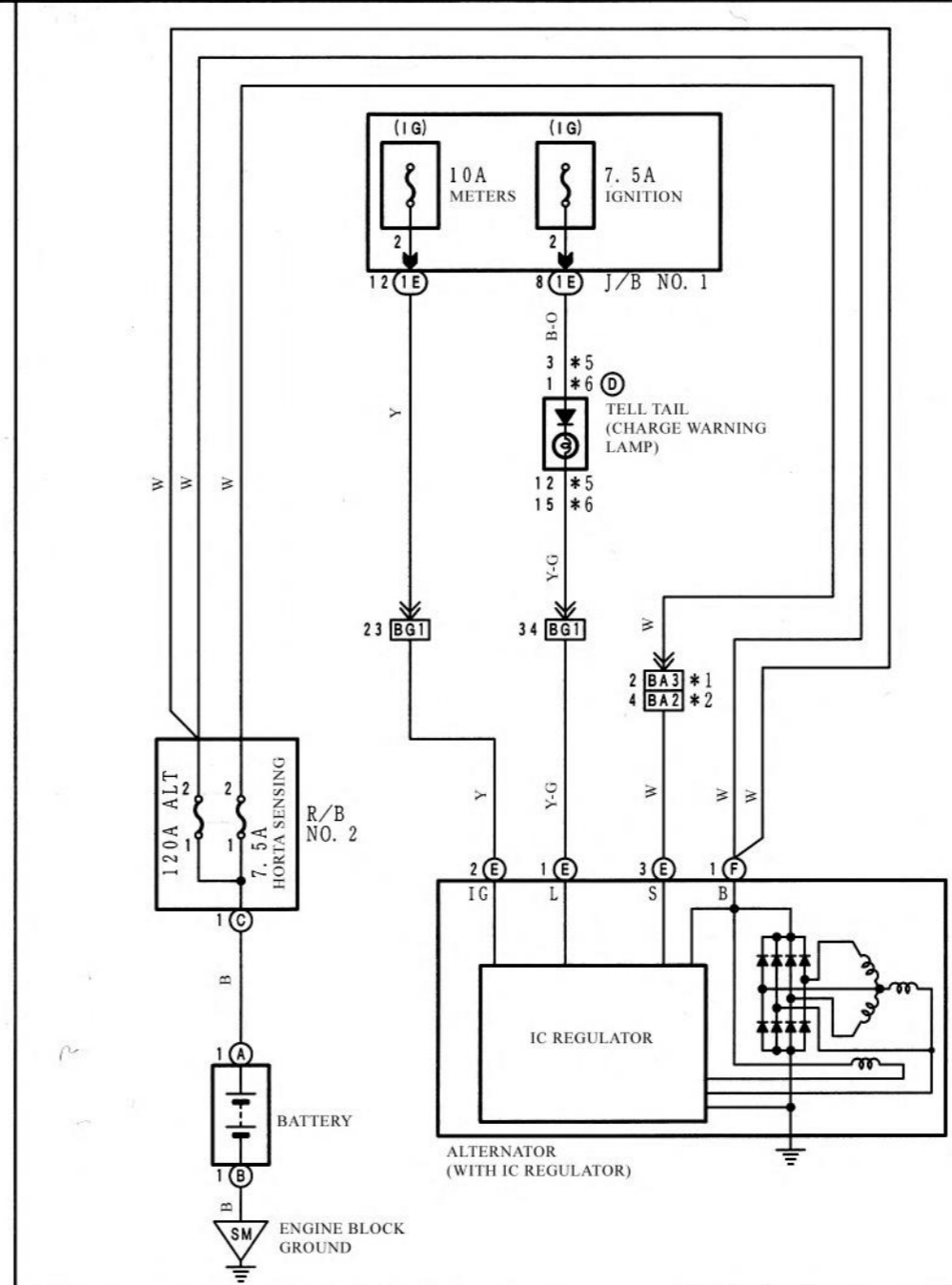

- *1: 2JZ-GE
- *2: 2JZ-GTE
- *3: ~'94.8
- *4: ~'94.8~
- *5: ~'96.4
- *6: ~'96.4~

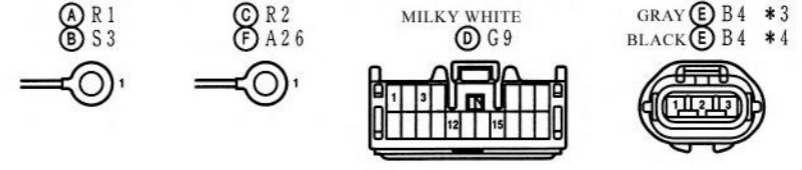
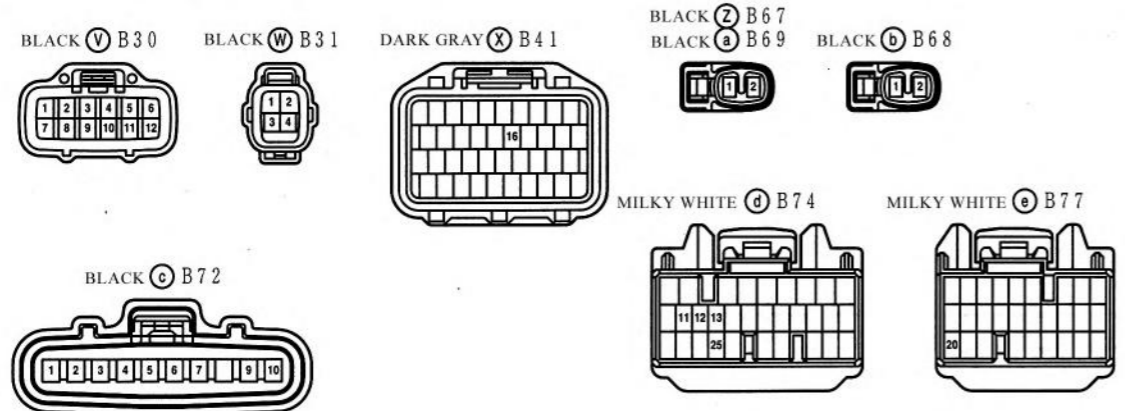

ENGINE CONTROL (~ '9 7 8 @ 2 JZ -. GTE)

*1: '94. 8 *4: '96. 4
*3: '96. 4

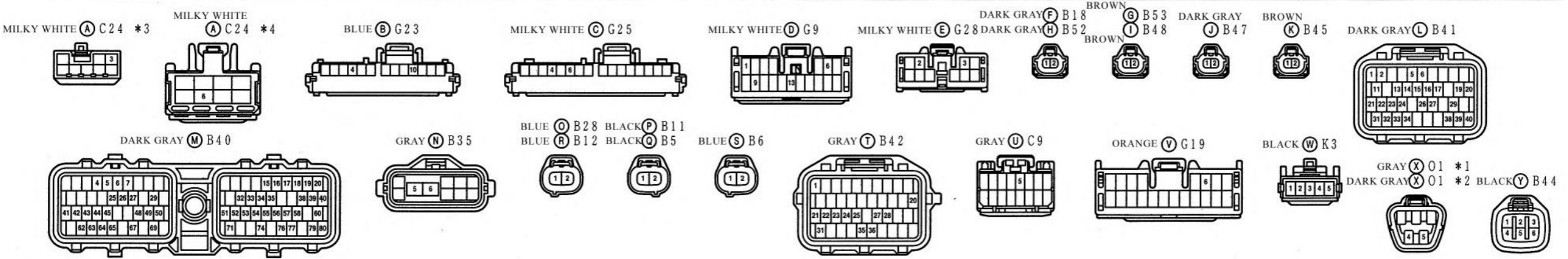
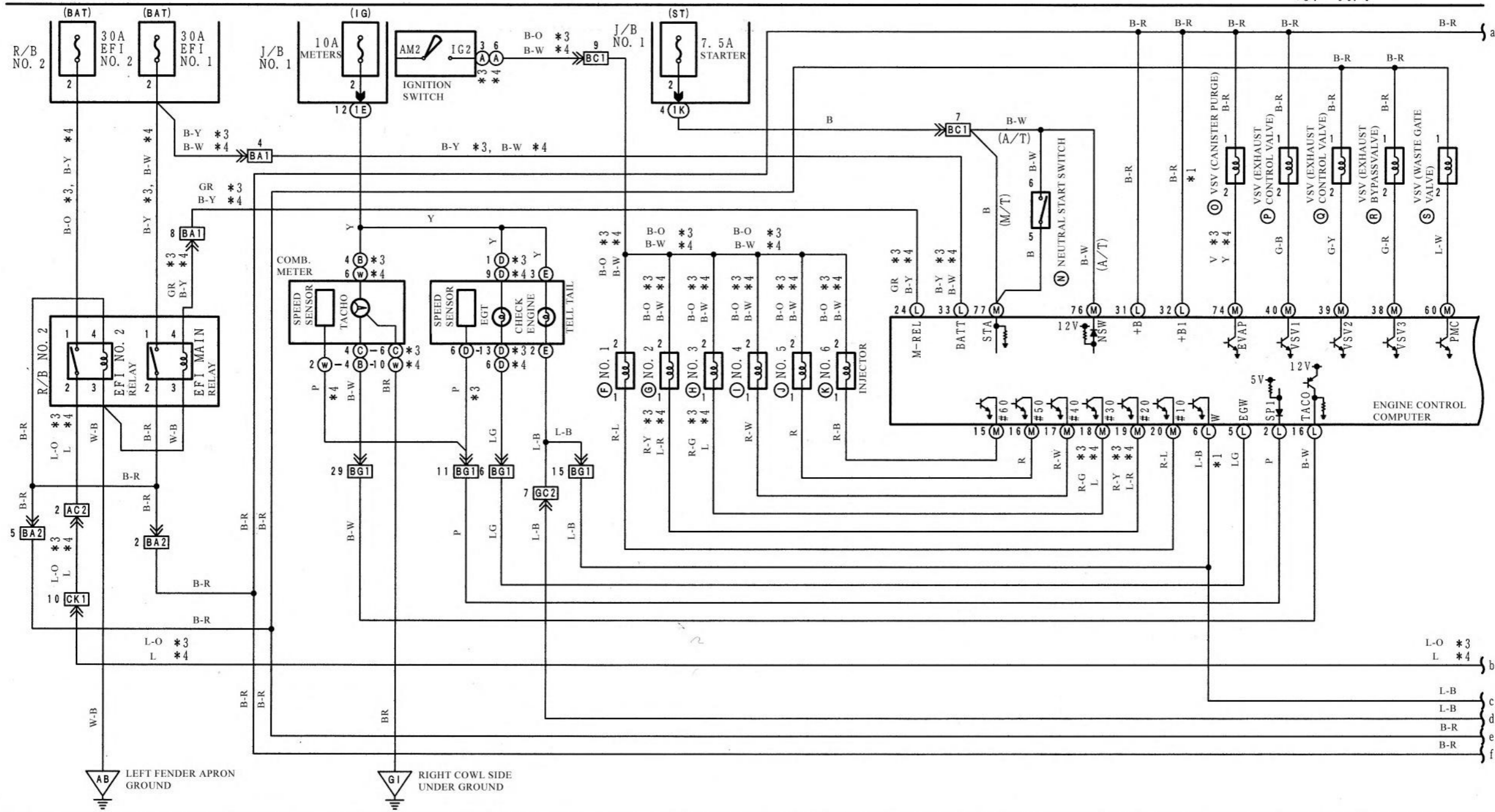

Engine control (~, 97. 8 @ 2 JZ-GTE)

*1: 94. 8 *3: 96. 4 *5: 96. 4 ~ EXCEPT S-ABS
 *2: 94. 8 ~ *4: 96. 4 ~ *6: 96. 4 ~ S-ABS

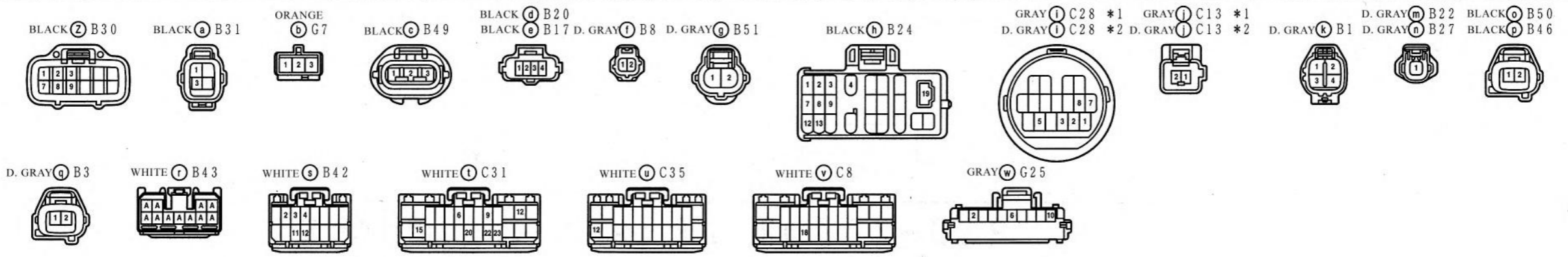
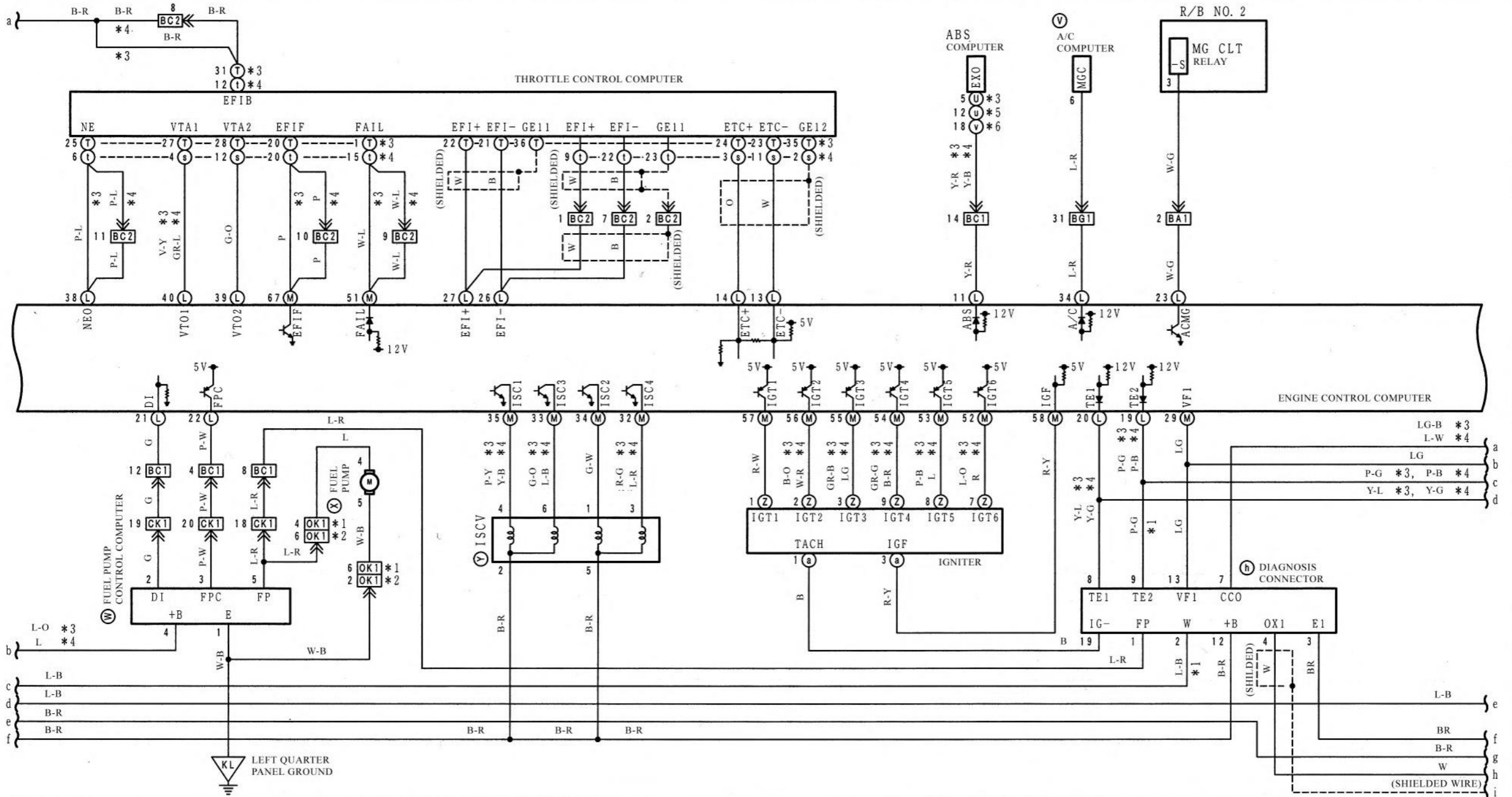

Engine control (~, 97.8 @ 2 JZ-GTE)

*1: '94.8 *4: '96.4
*3: '96.4

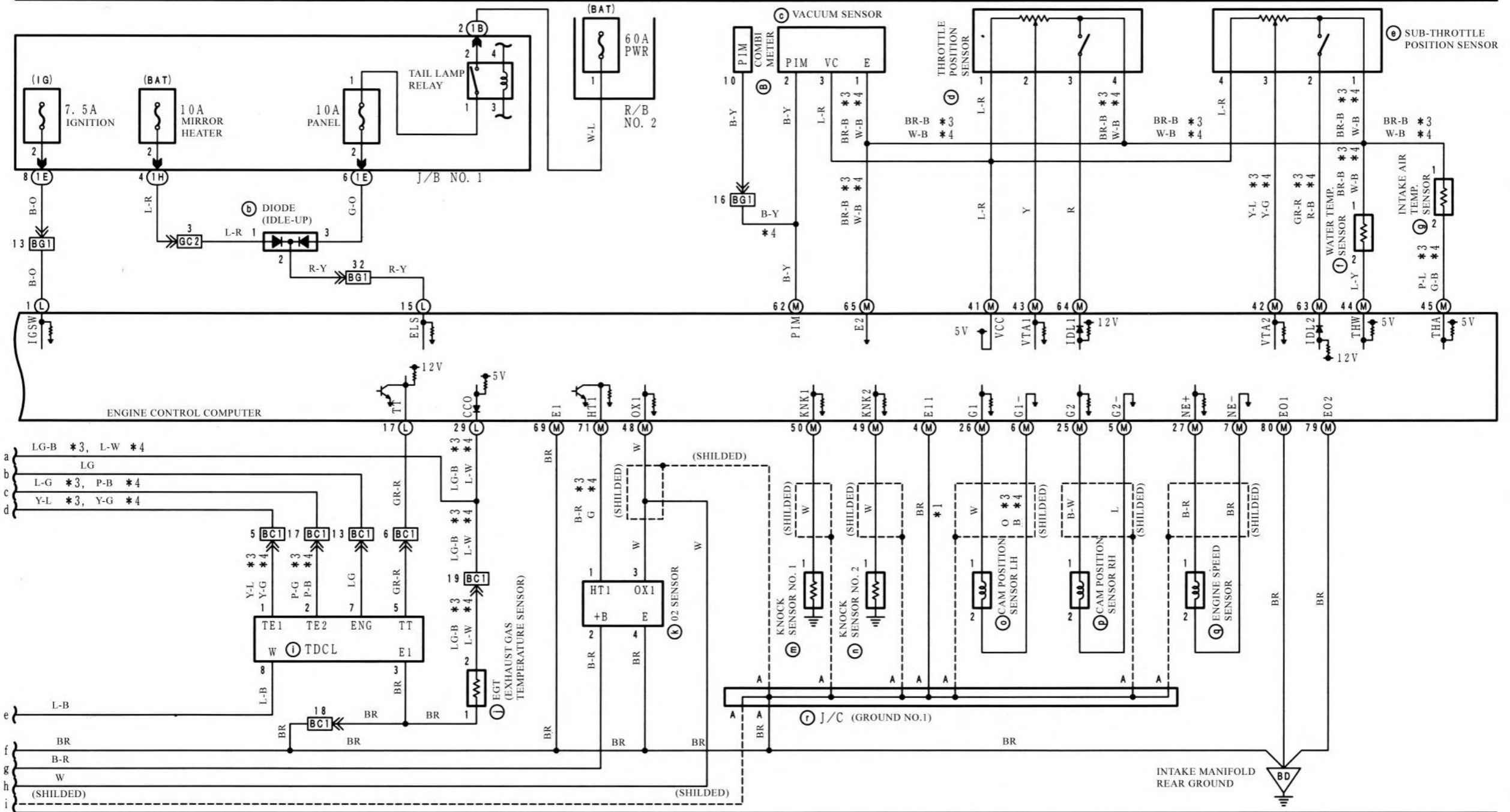

Front wiper and washer

Rear wiper and washer

*1: ~'97.8 *2: '97.8~

- *1: ~'95.5
- *2: '95.5~
- *3: ~'96.4
- *4: '96.4~
- *5: ~'97.8
- *6: '97.8~

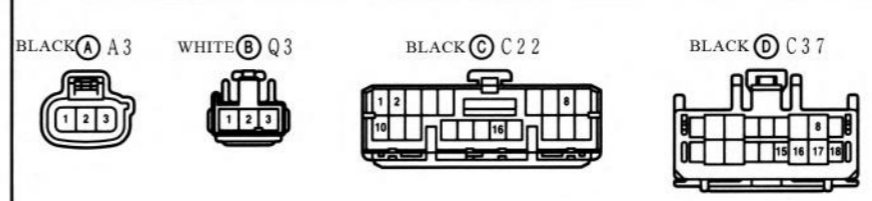
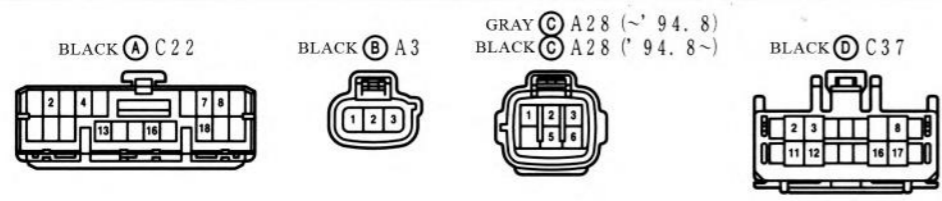
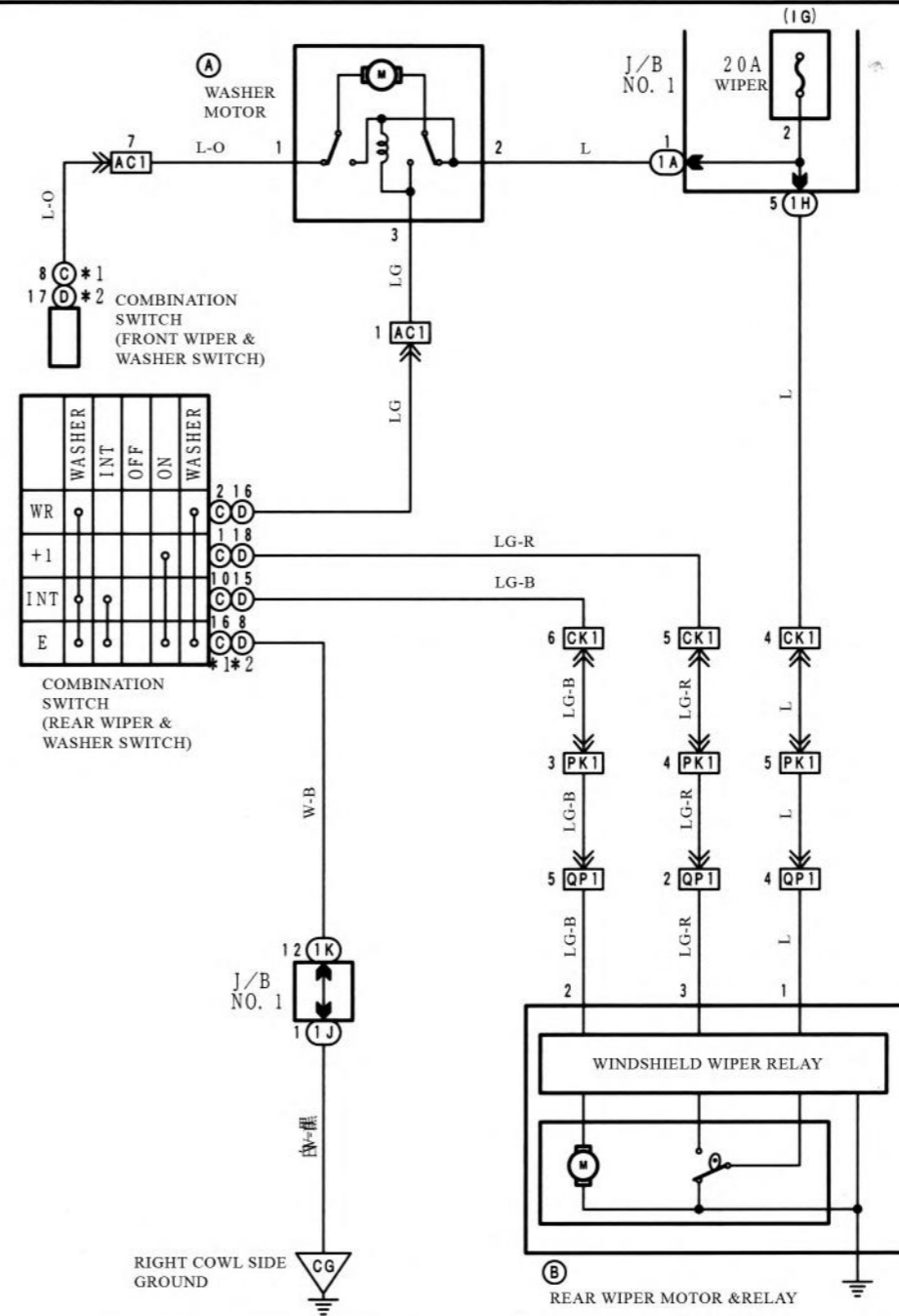
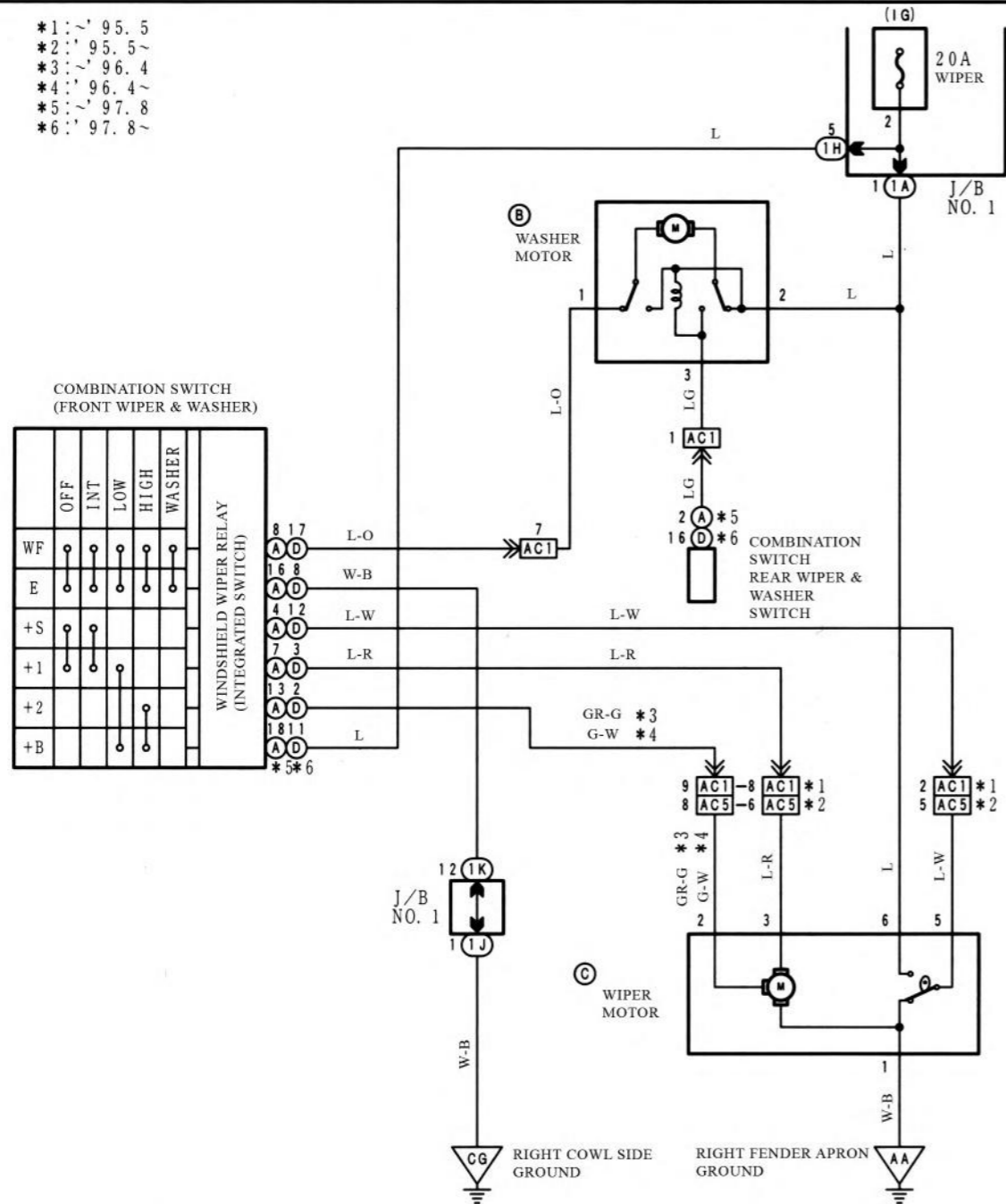

Engine control (2JZ-GE)

*1: ~'94.2 *5: ~'96.4 ~
*4: ~'96.4 *6: ~'97.8

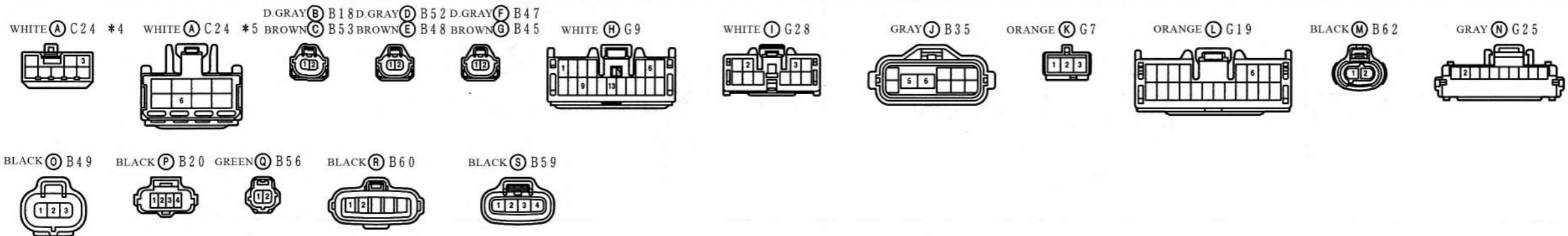
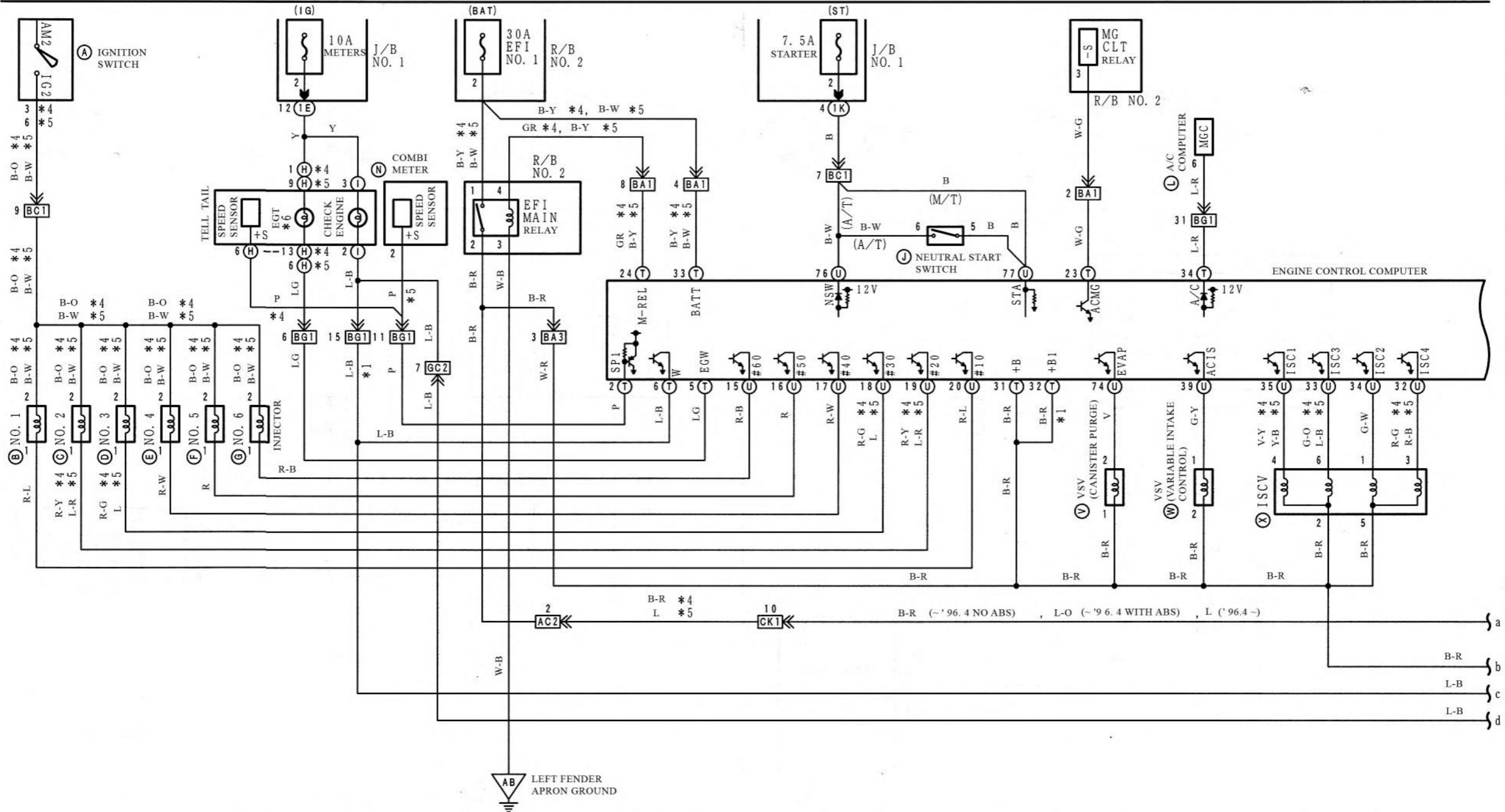

Engine control (2 JZ - GE)

*1: ~'94.2 *4: ~'96.4 *6: ~'97.8
 *2: ~'94.2 *5: ~'96.4 *7: ~'97.8

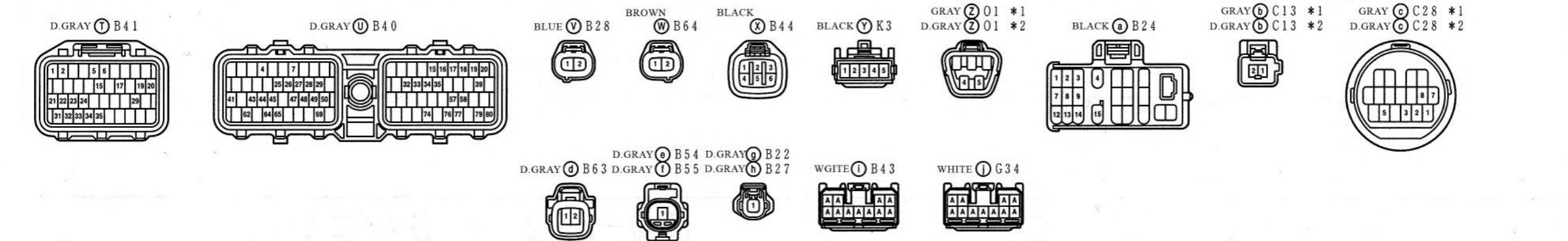
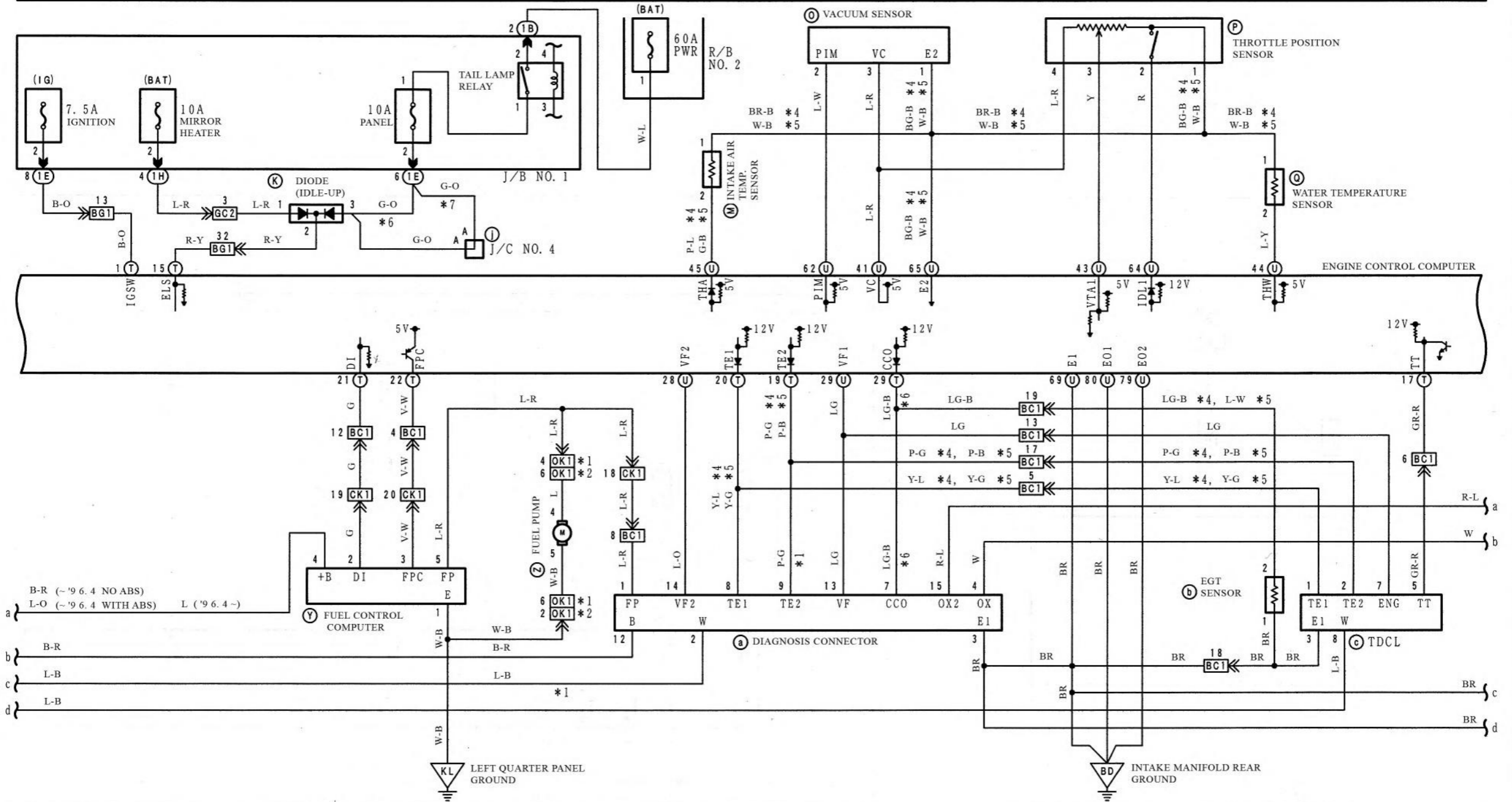

Engine control (2JZ - GE)

Shift lock (straight type)

*1: '94.2
*4: '96.4
*5: '96.4~

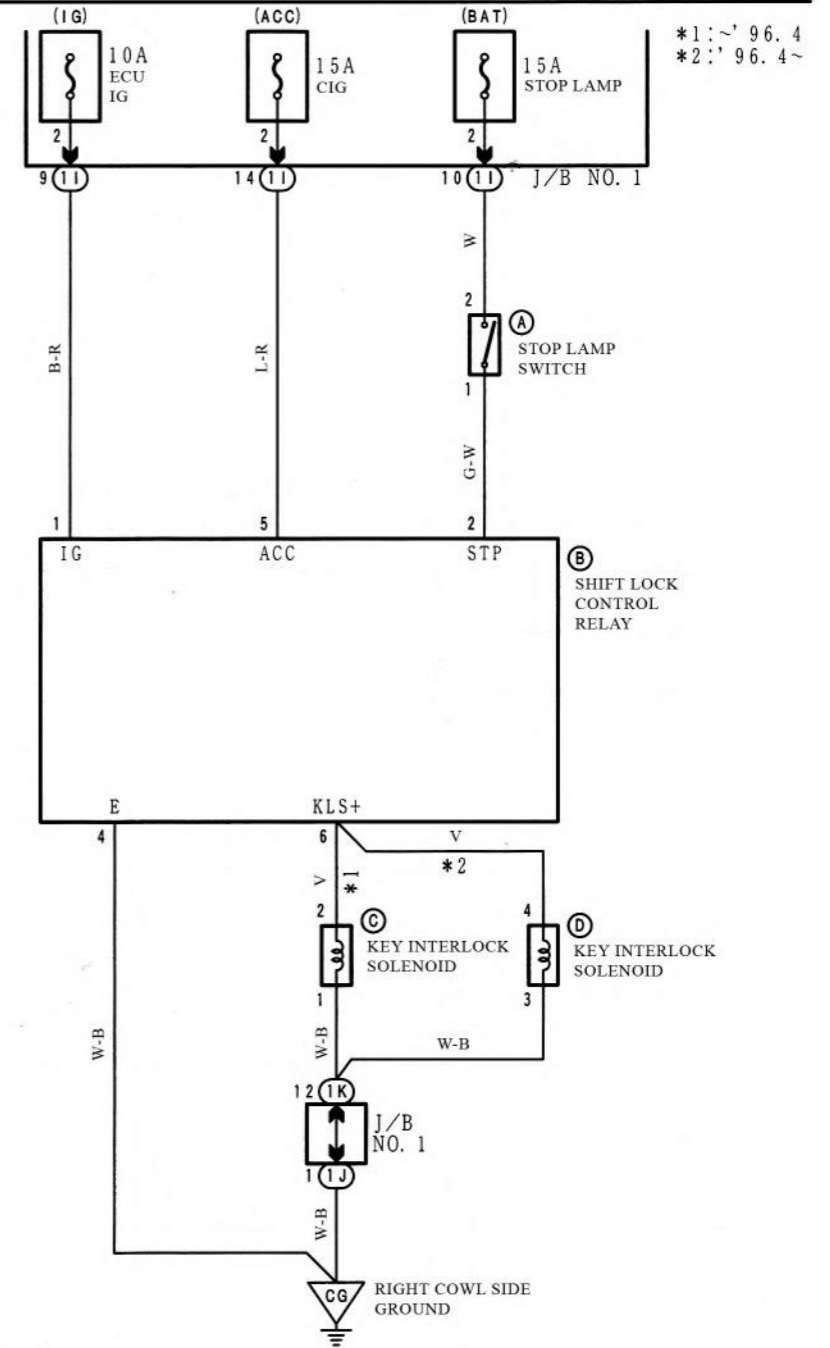
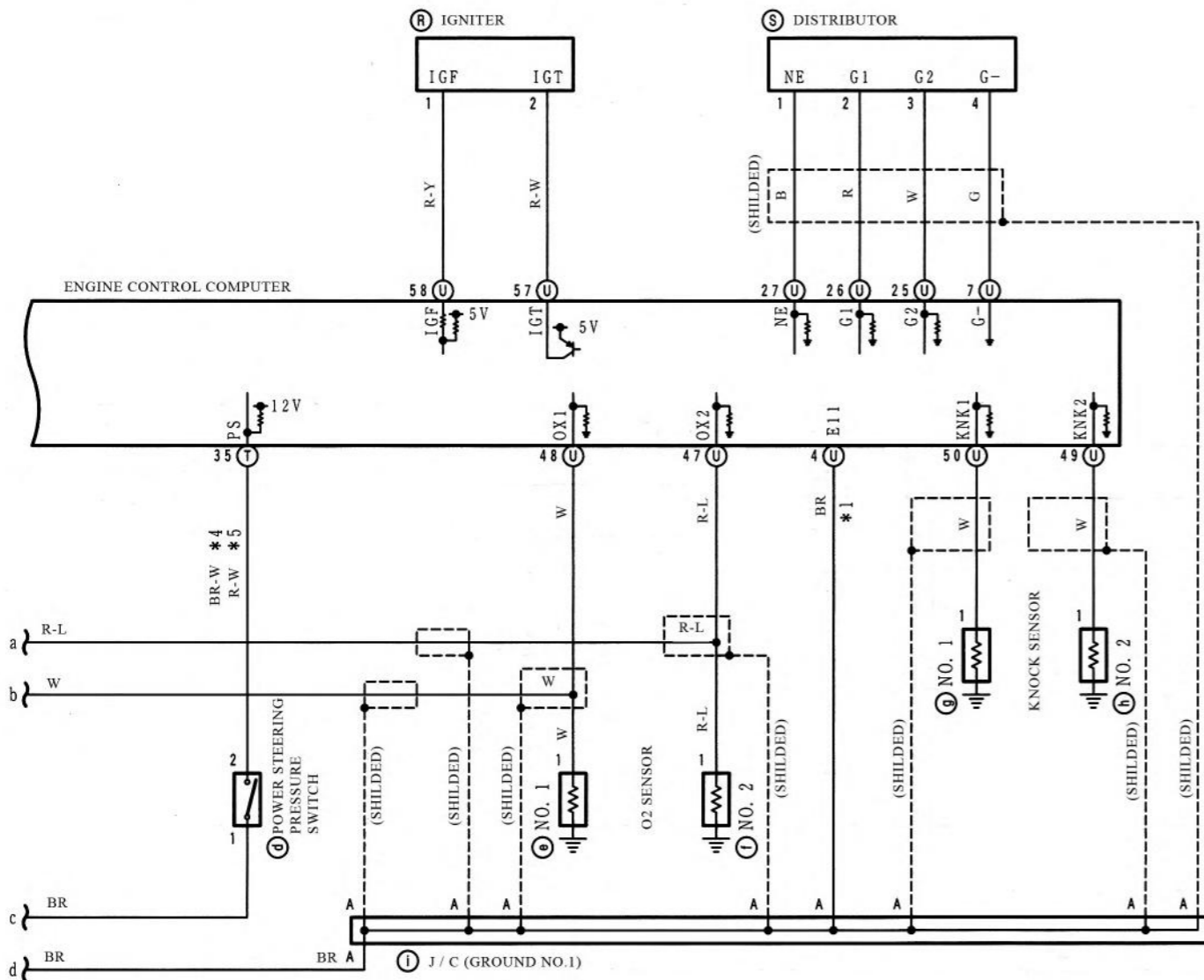

*1: '96.4
*2: '96.4~

BLACK (A) C23 WHITE (B) C16 WHITE (C) C26 *1 WHITE (D) C25 *2

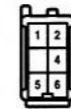
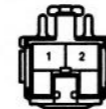

Outer mirror

*1: ~'94.8, '96.4~
*2: '94.8~'96.4
*3: ~'96.4
*4: '96.4~

Warning forget to pull out the key

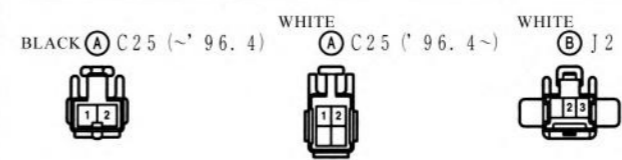
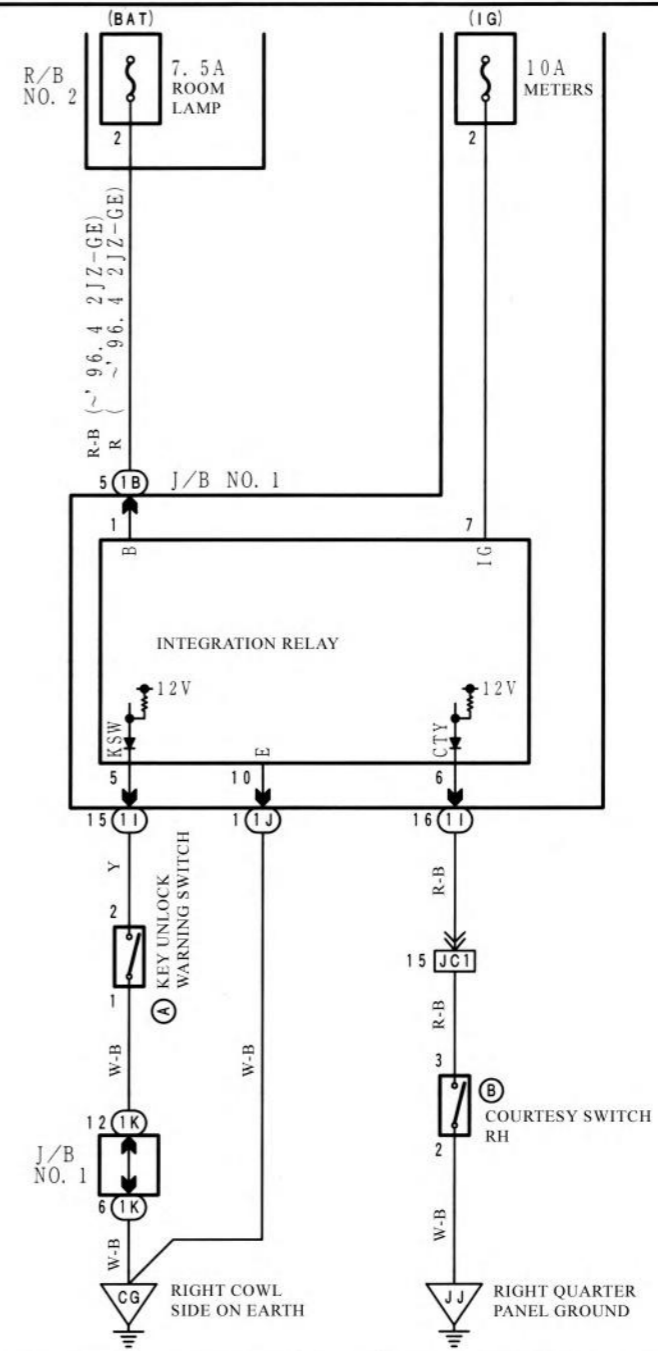
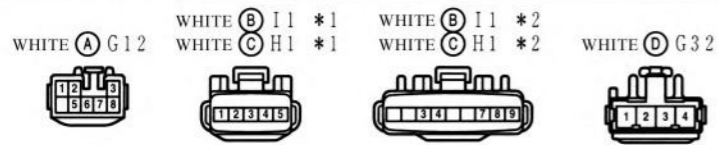
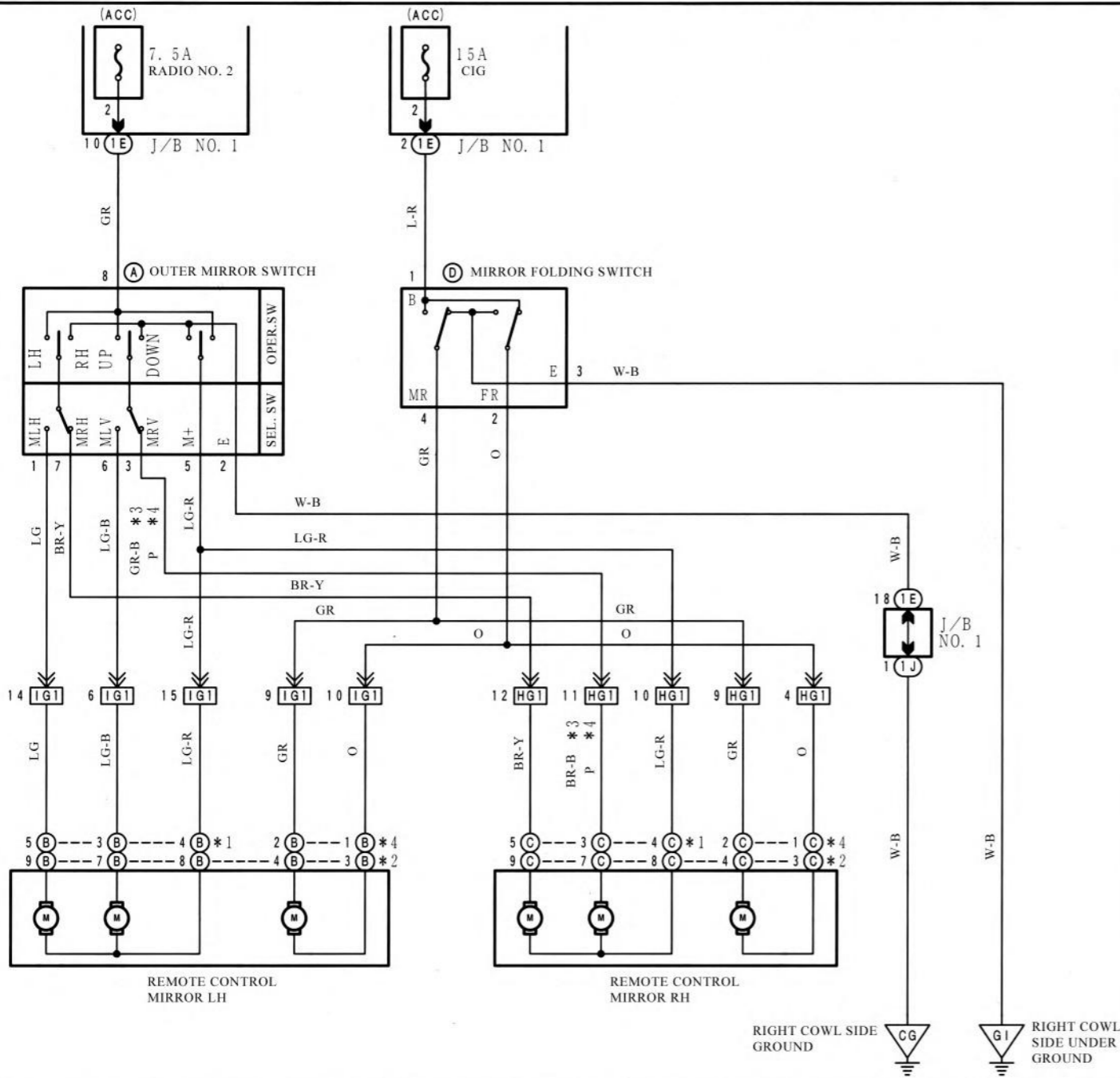

Engine control (, 9 7.8 ~ @ 2 JZ - . GTE)

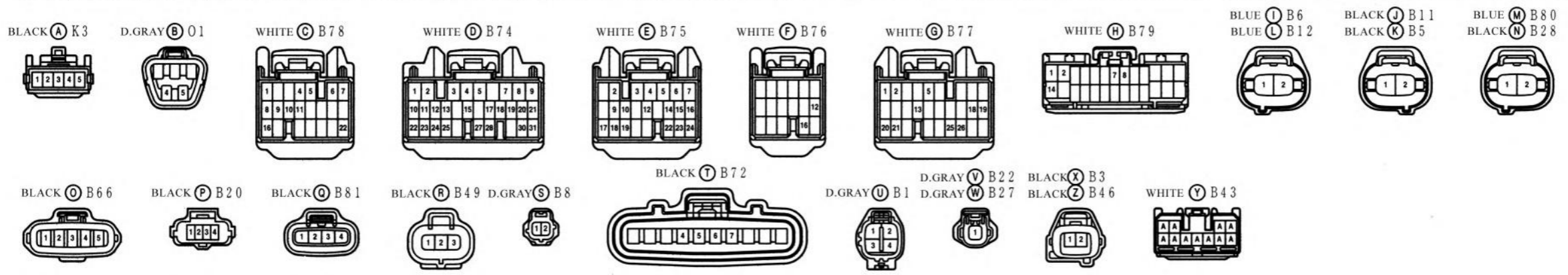
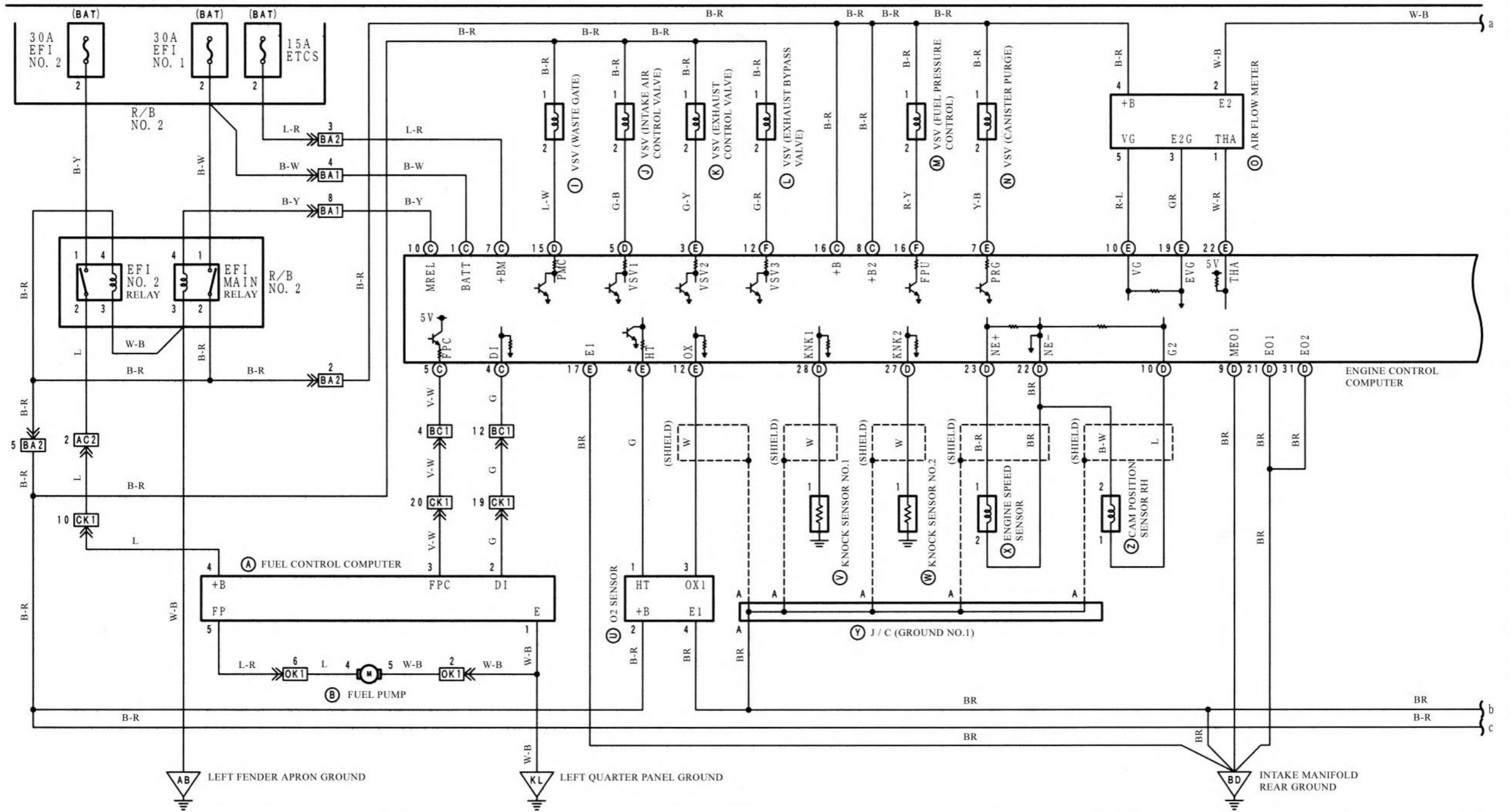

Engine control (, 9 7. 8 ~ @ 2 JZ-GTE)

*1 : EXCEPT S-ABS
 *2 : S-ABS

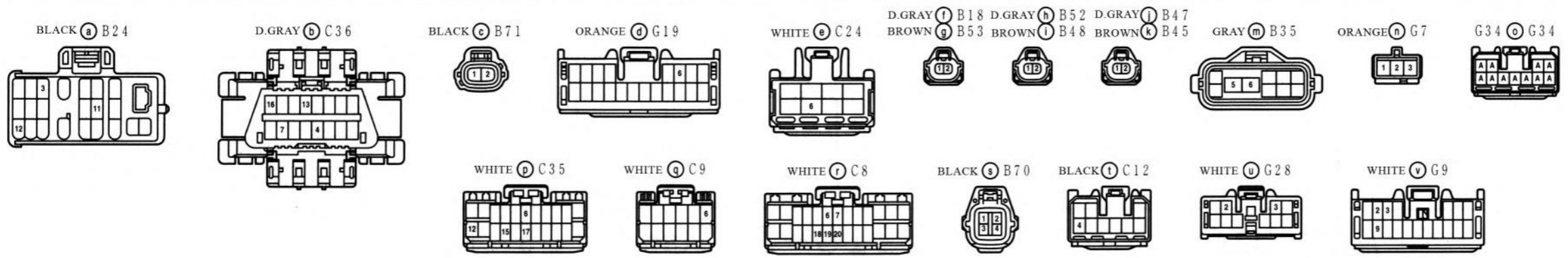
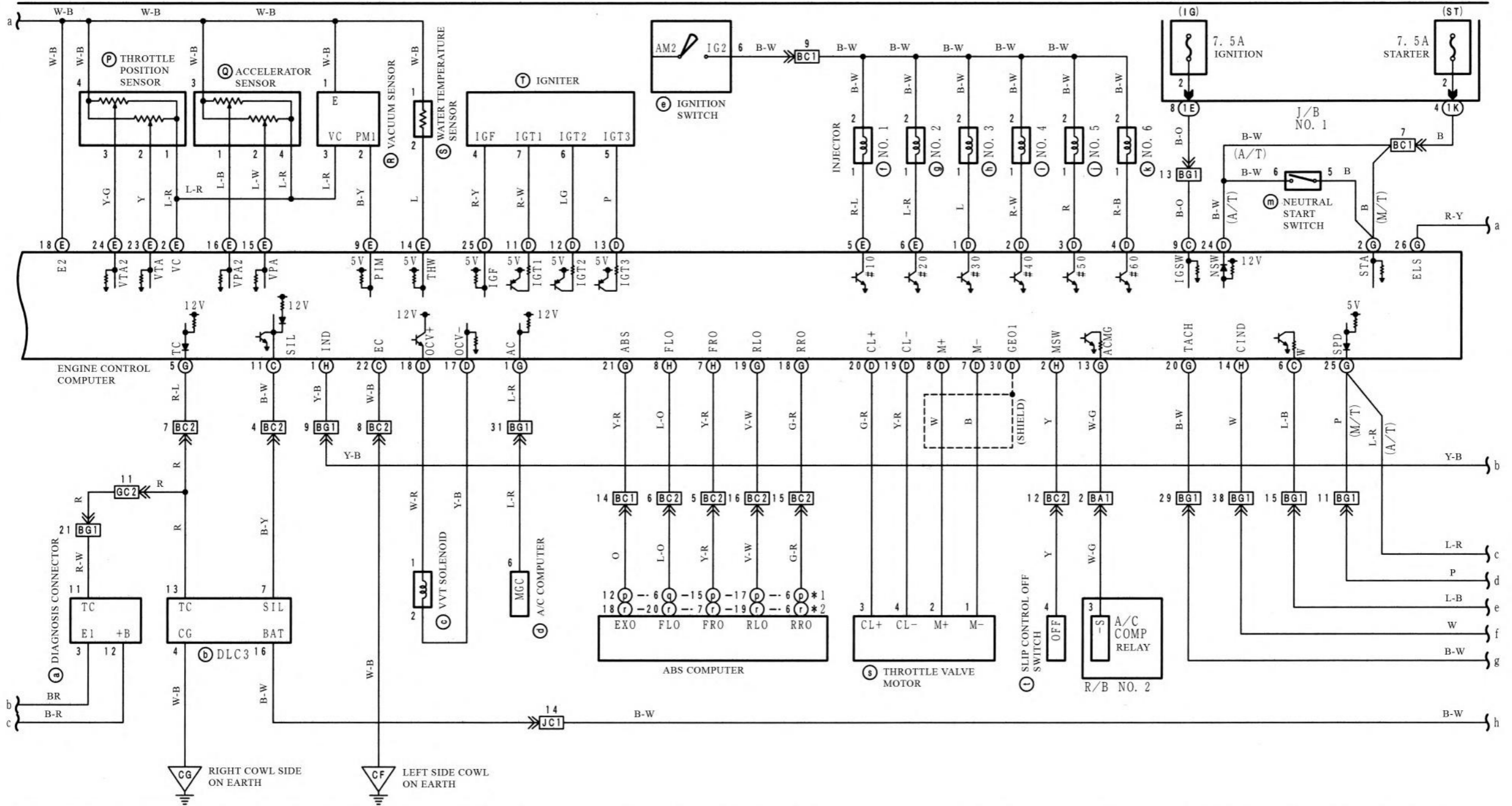

Engine control ('9 7 8 ~ @ 2 JZ -. GTE)

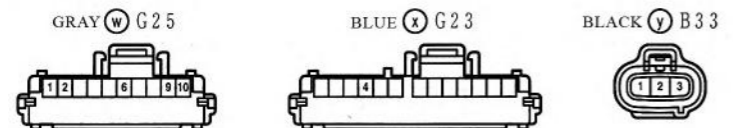
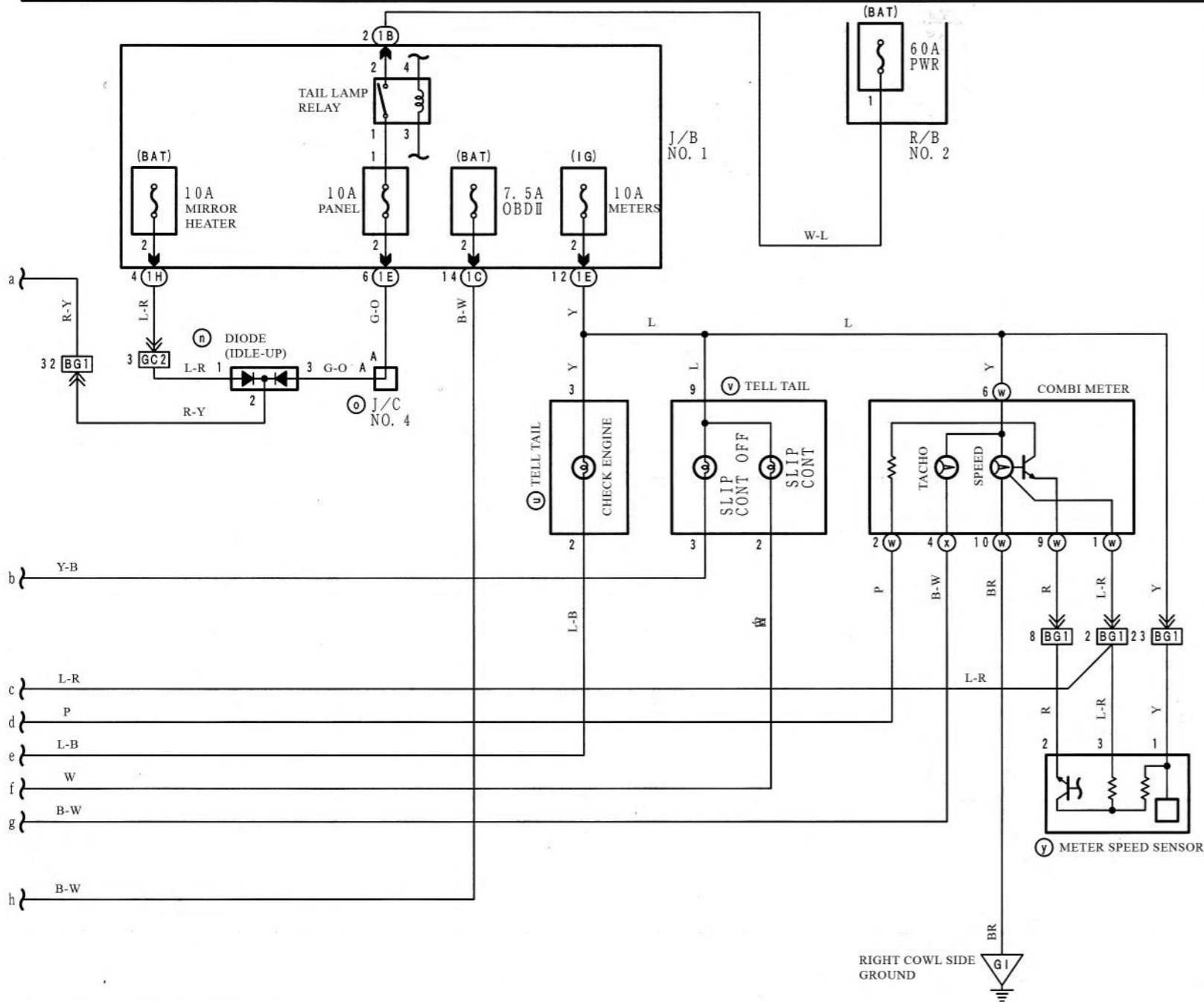

Front power seat

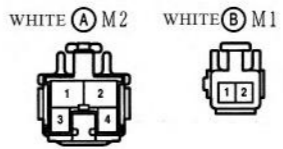
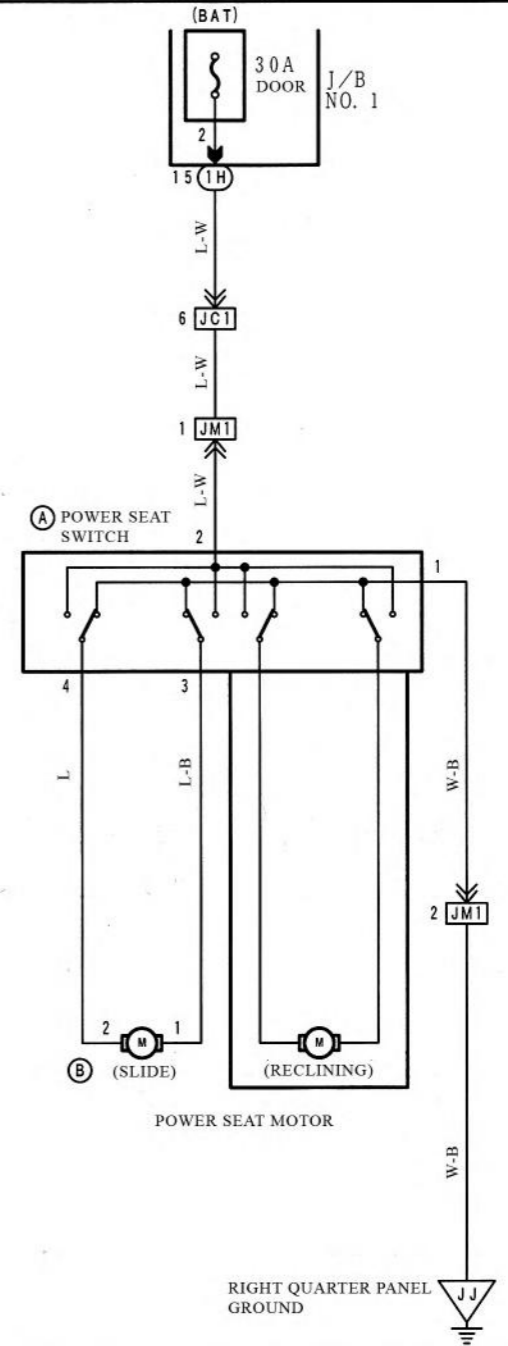

Active front spoiler

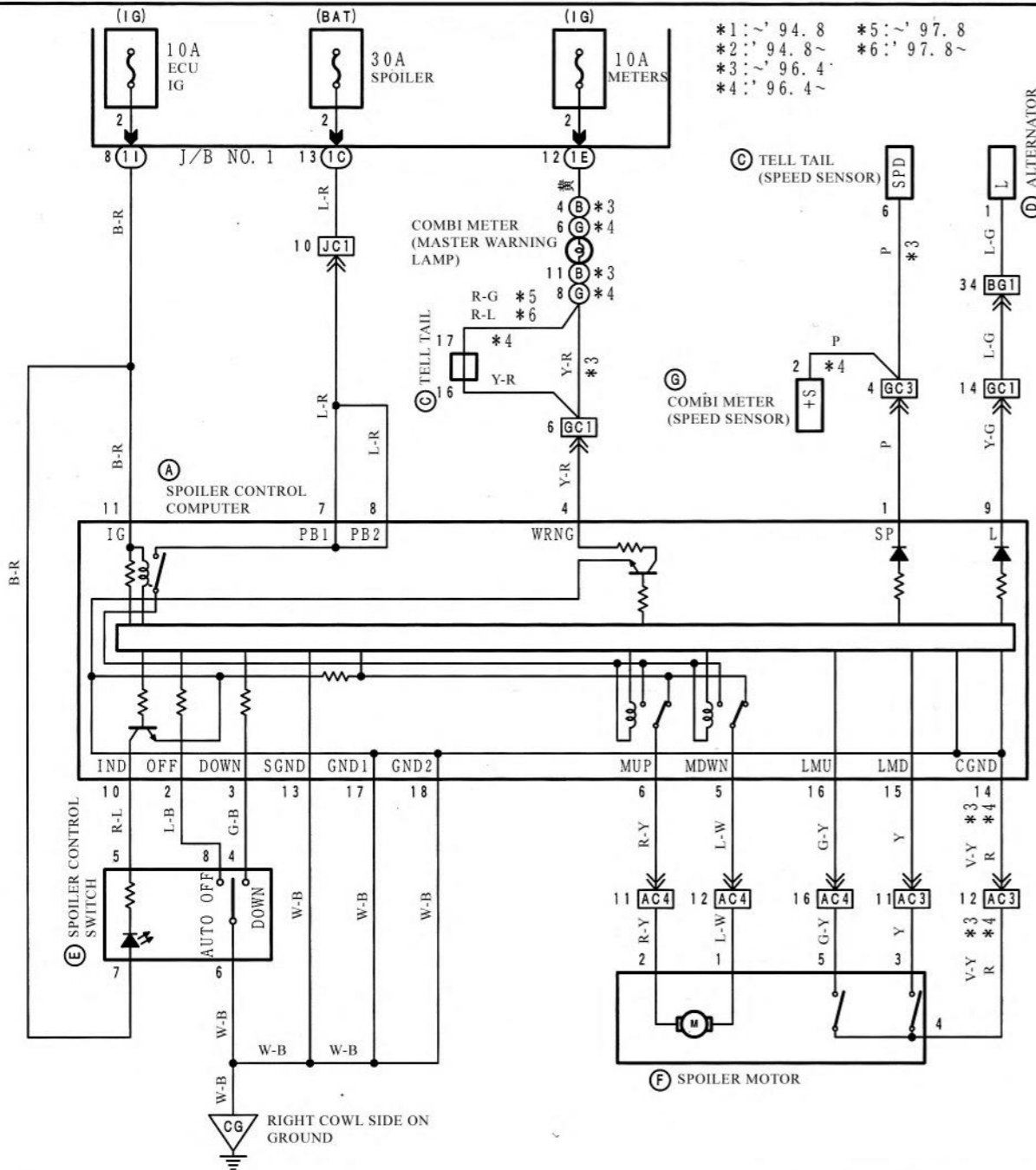

Power window

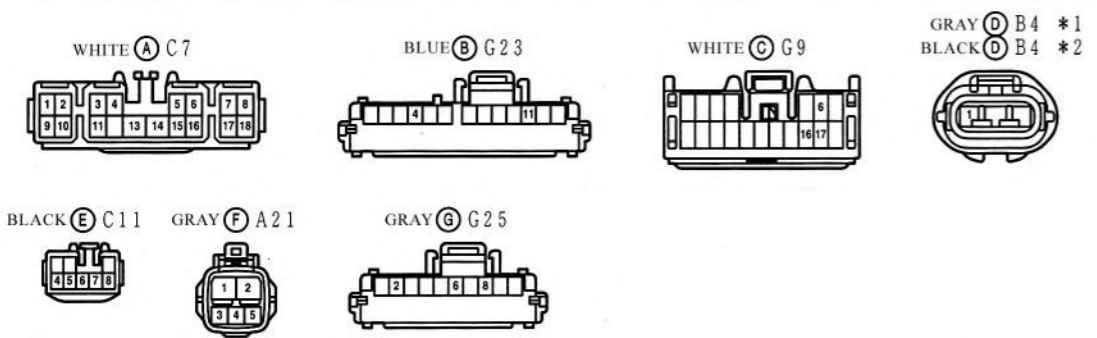
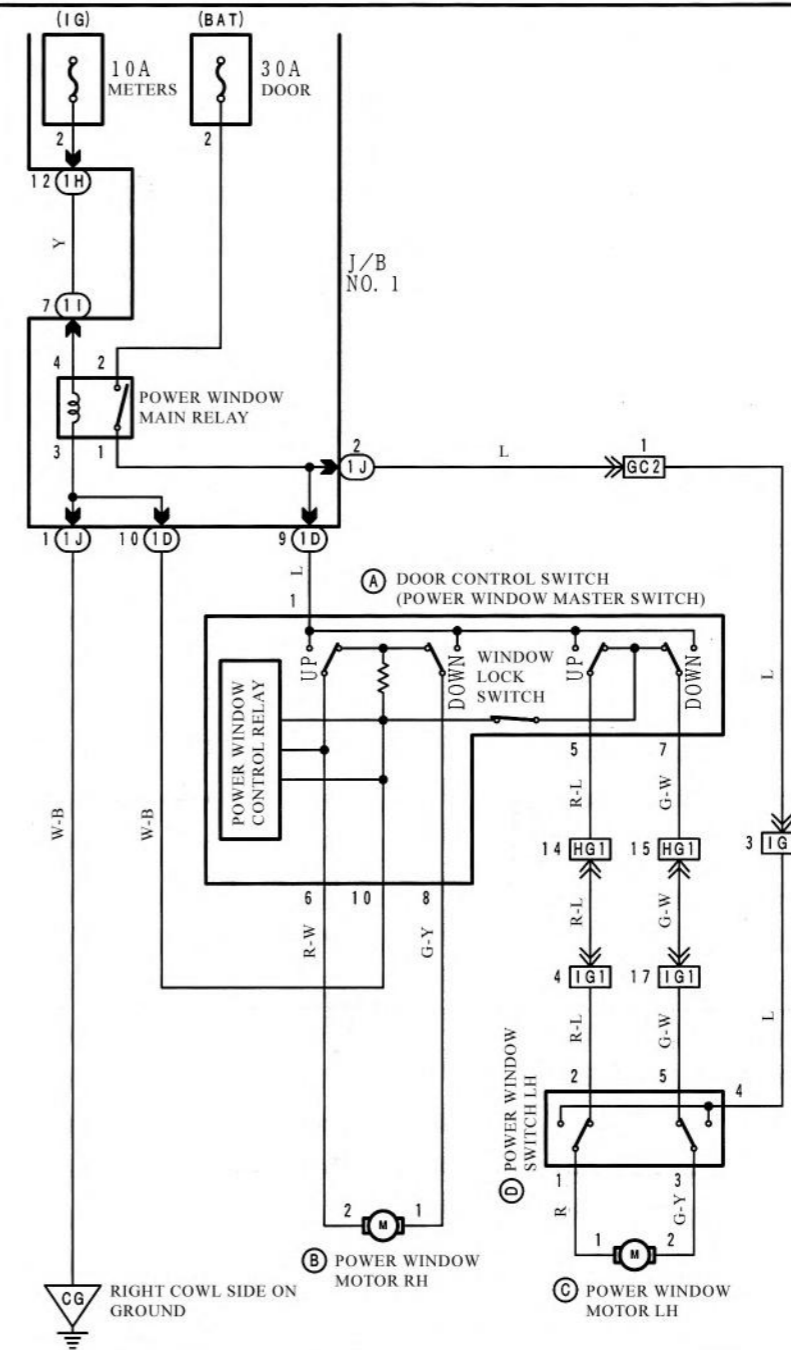

ECT (~, 97.8 @ 2 JZ-GTE)

*1: '94.8 *5: '96.4
*2: '94.8 *6: '96.4

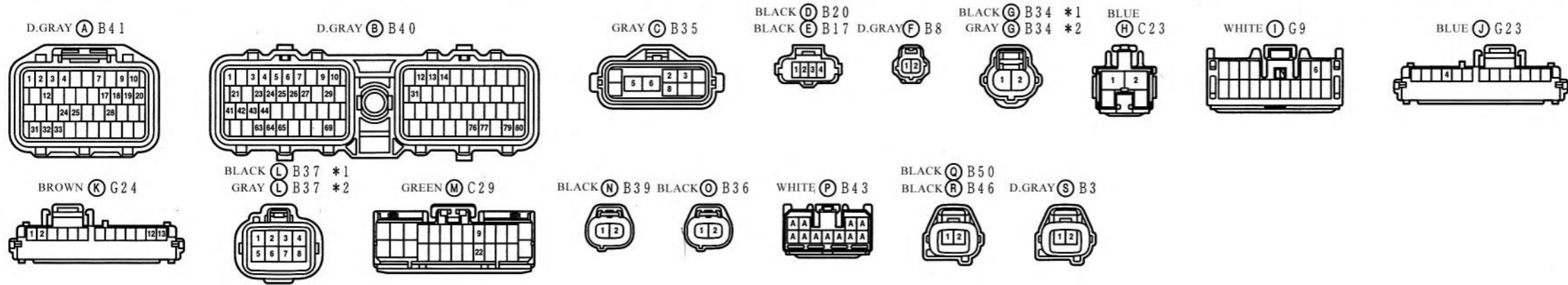
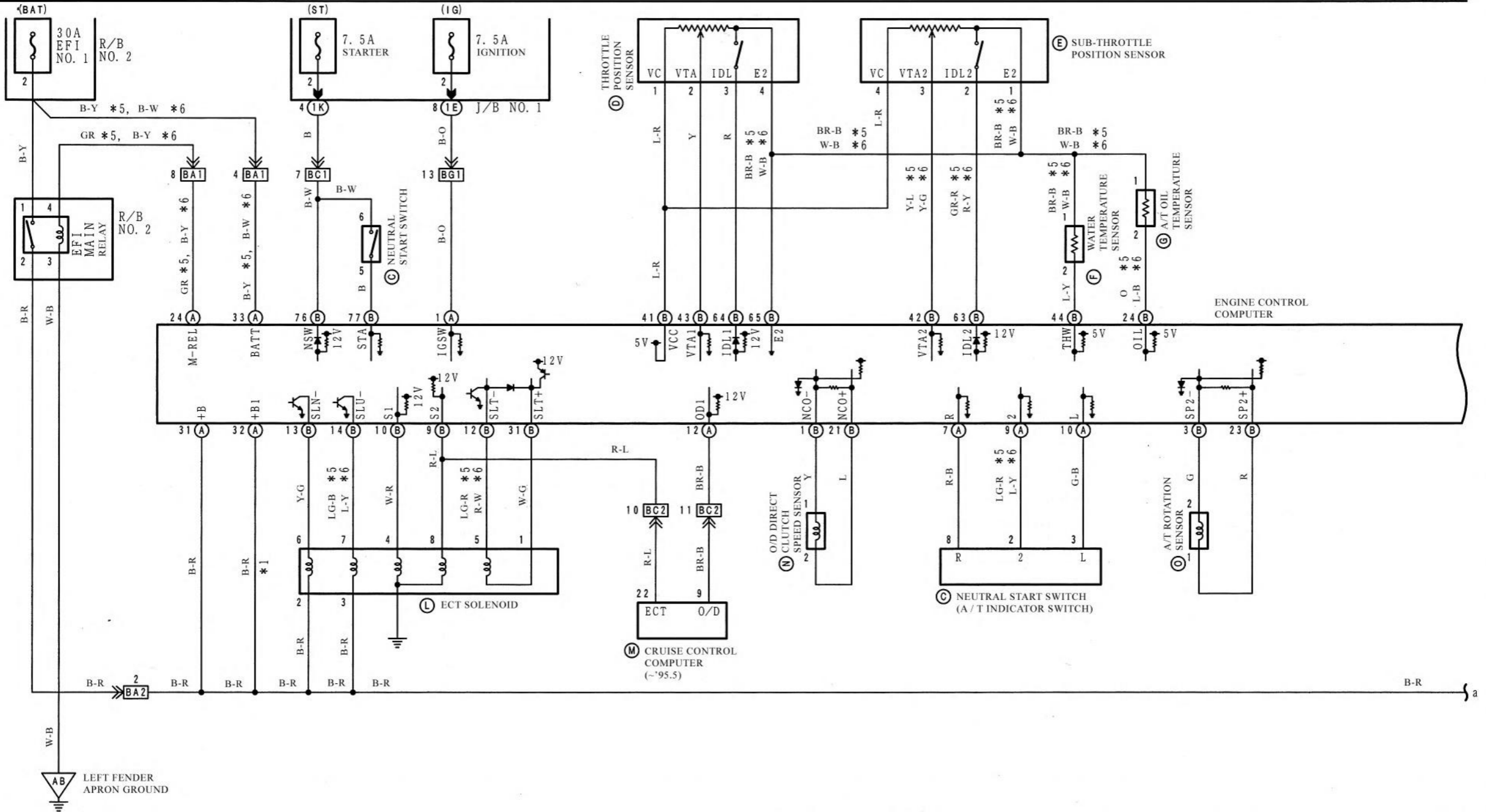

ECT (~ '97. 8 @ 2 JZ-GTE)

*1: ~ '94. 8 *3: ~ '95. 5 *6: ~ '96. 4 ~
 *2: ~ '94. 8 ~ *5: ~ '96. 4 *7: ~ '95. 5 ~ '96. 4

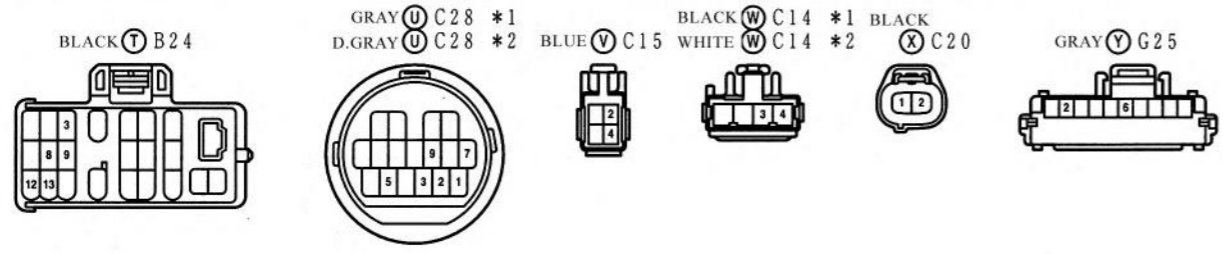
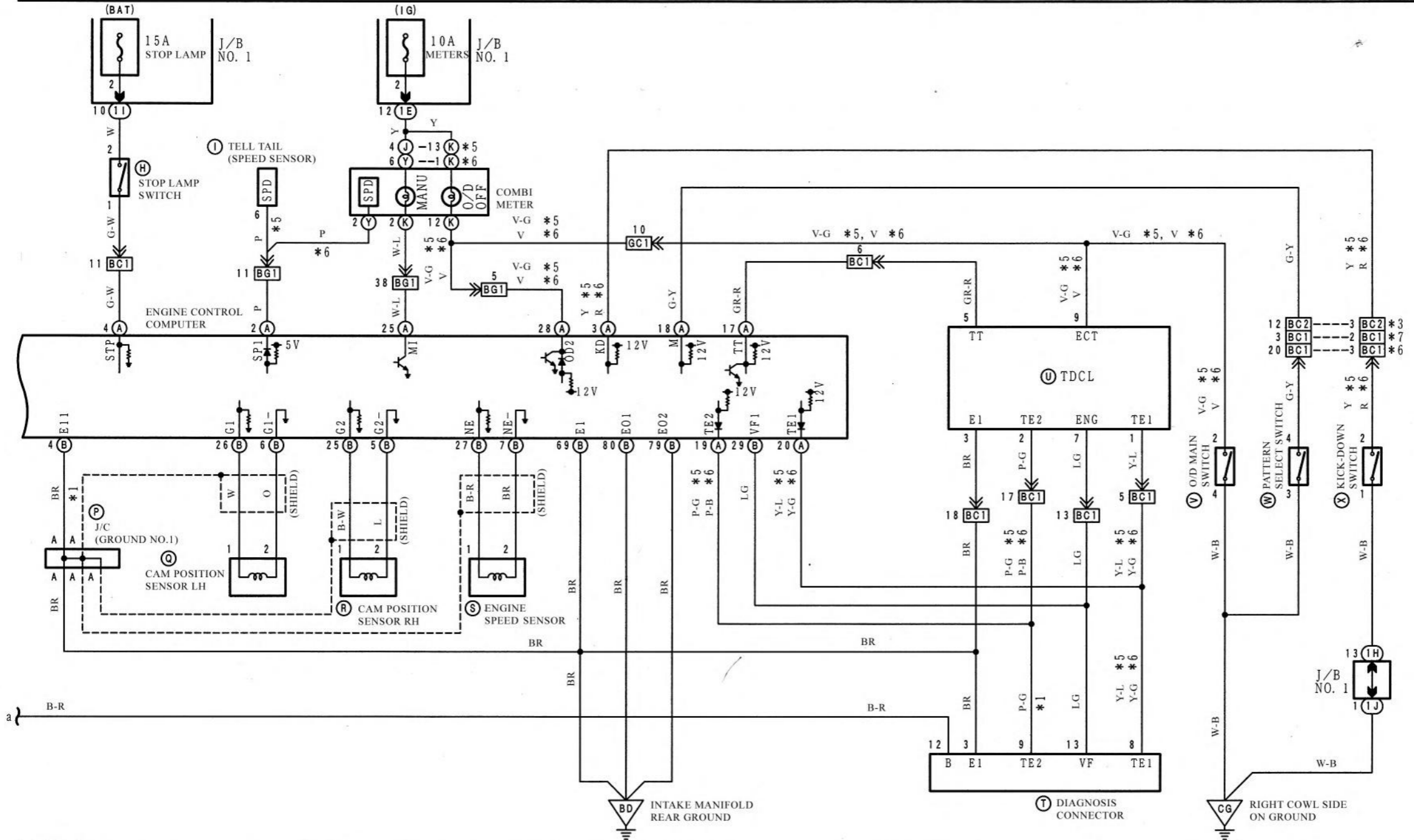

ECT ('9 7. 8 ~ @ 2JZ-GTE)

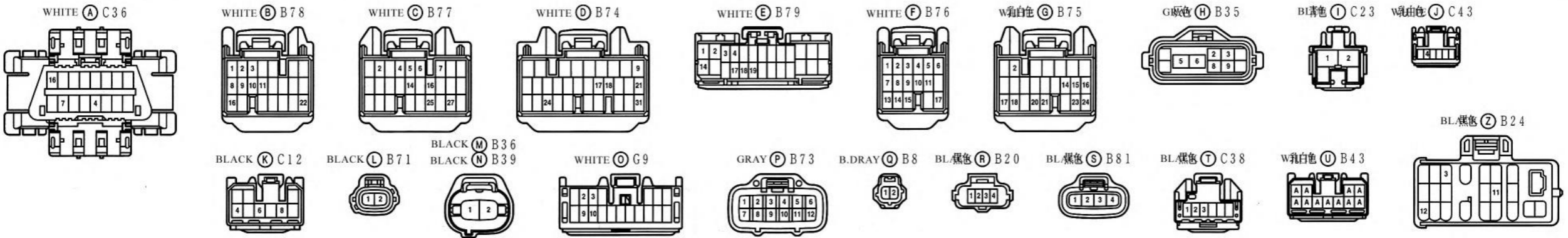
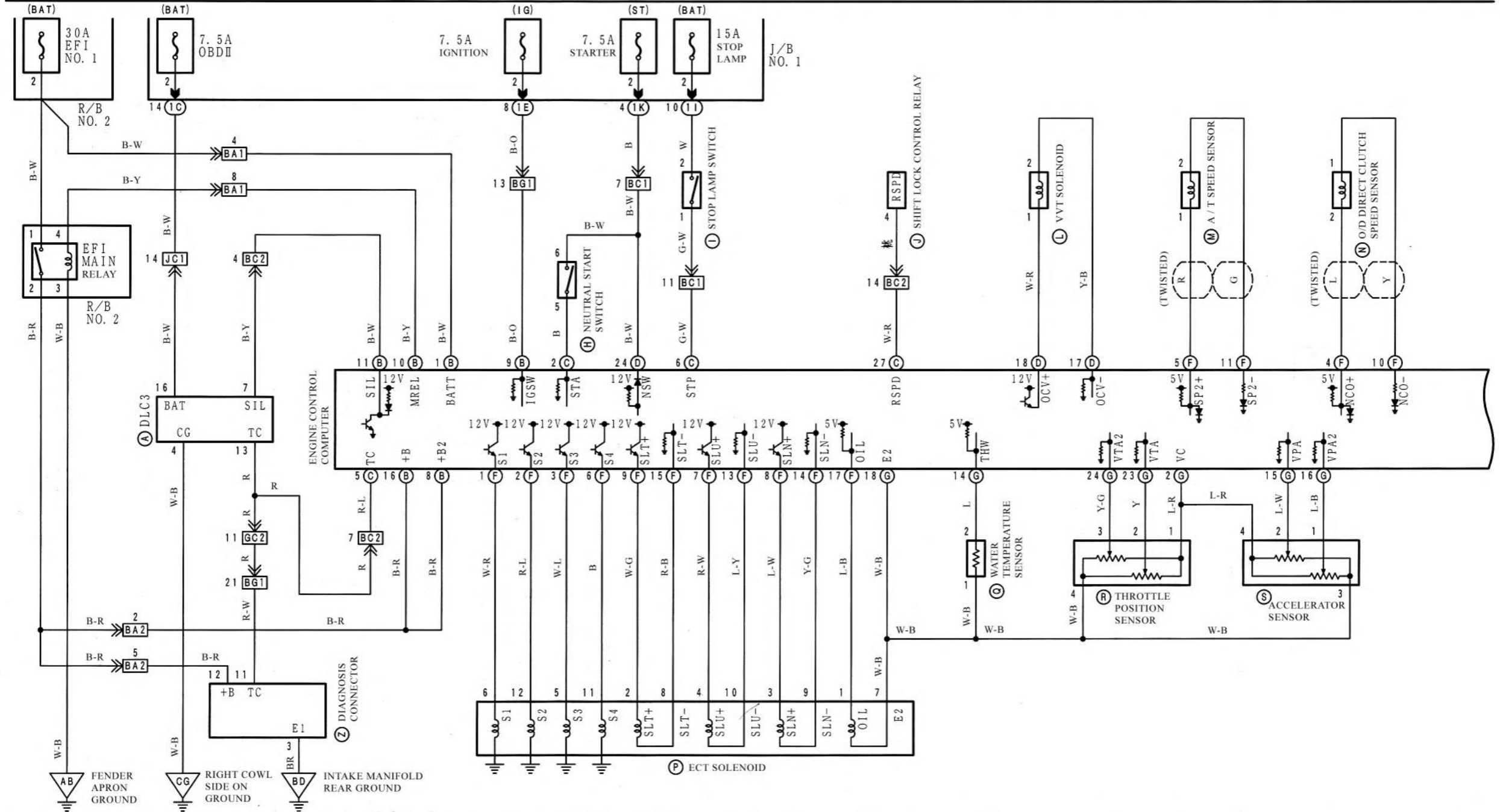

ECT ('97.8 ~ @ 2 JZ-GTE)

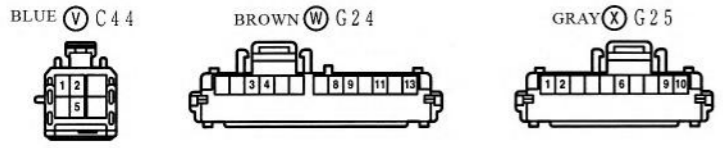
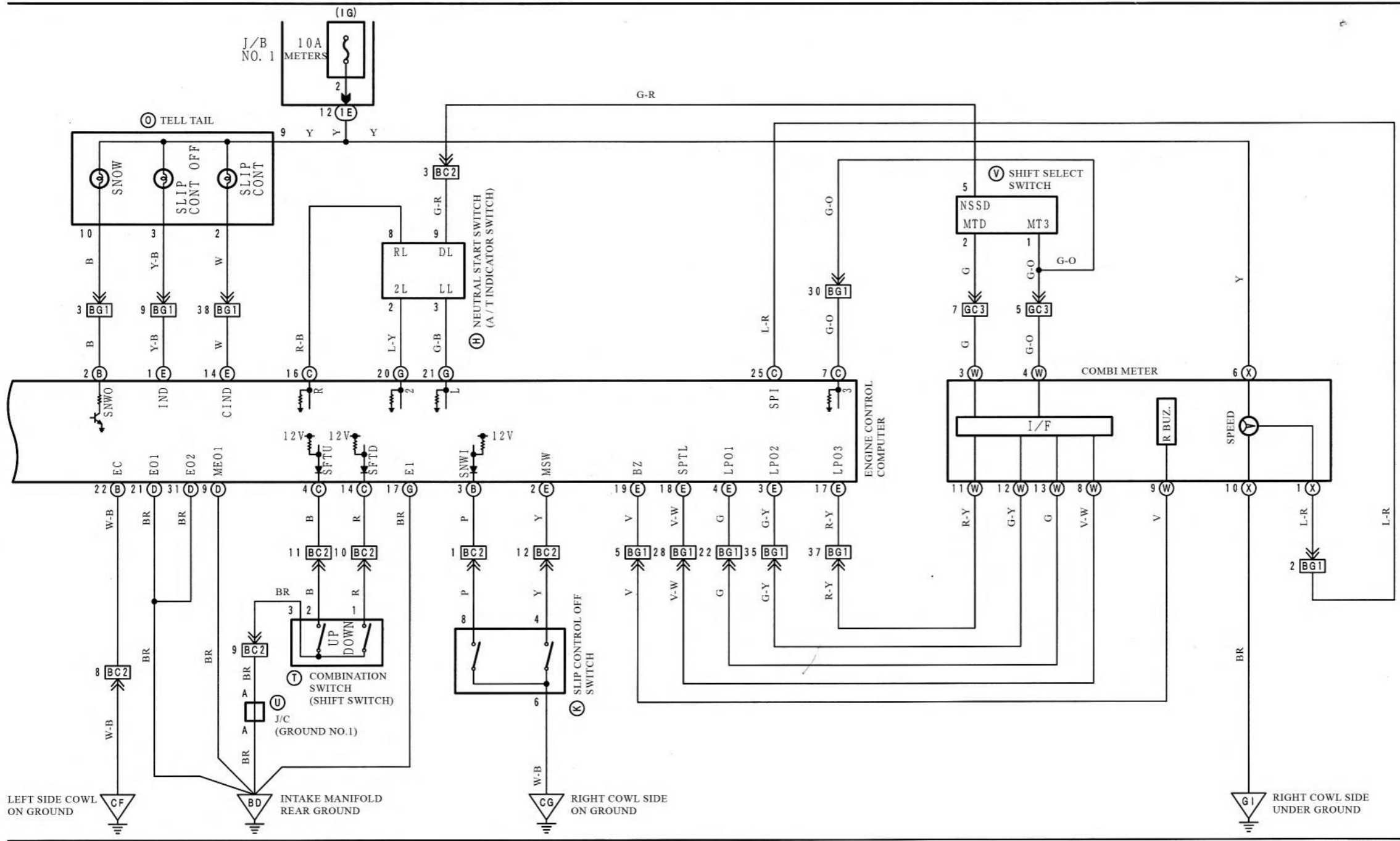

ECT (2JZ-GE)

*1: ~ 94.8 *5: ~ 96.4 *8: ~ 97.8
 *2: ~ 94.8 *6: ~ 96.4

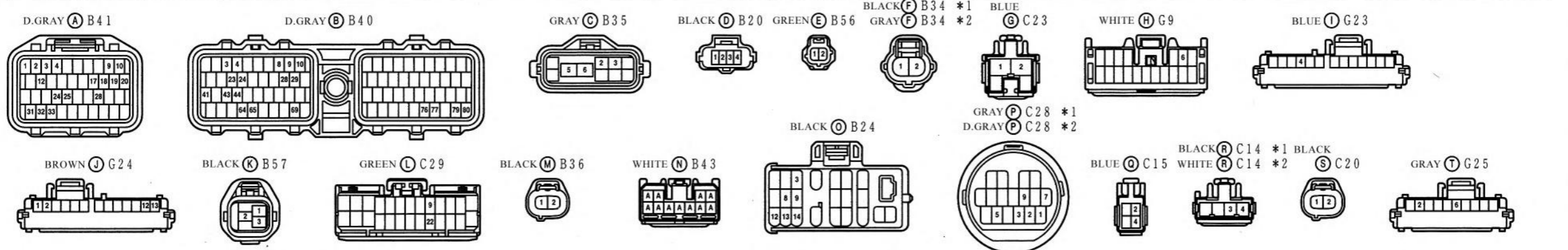
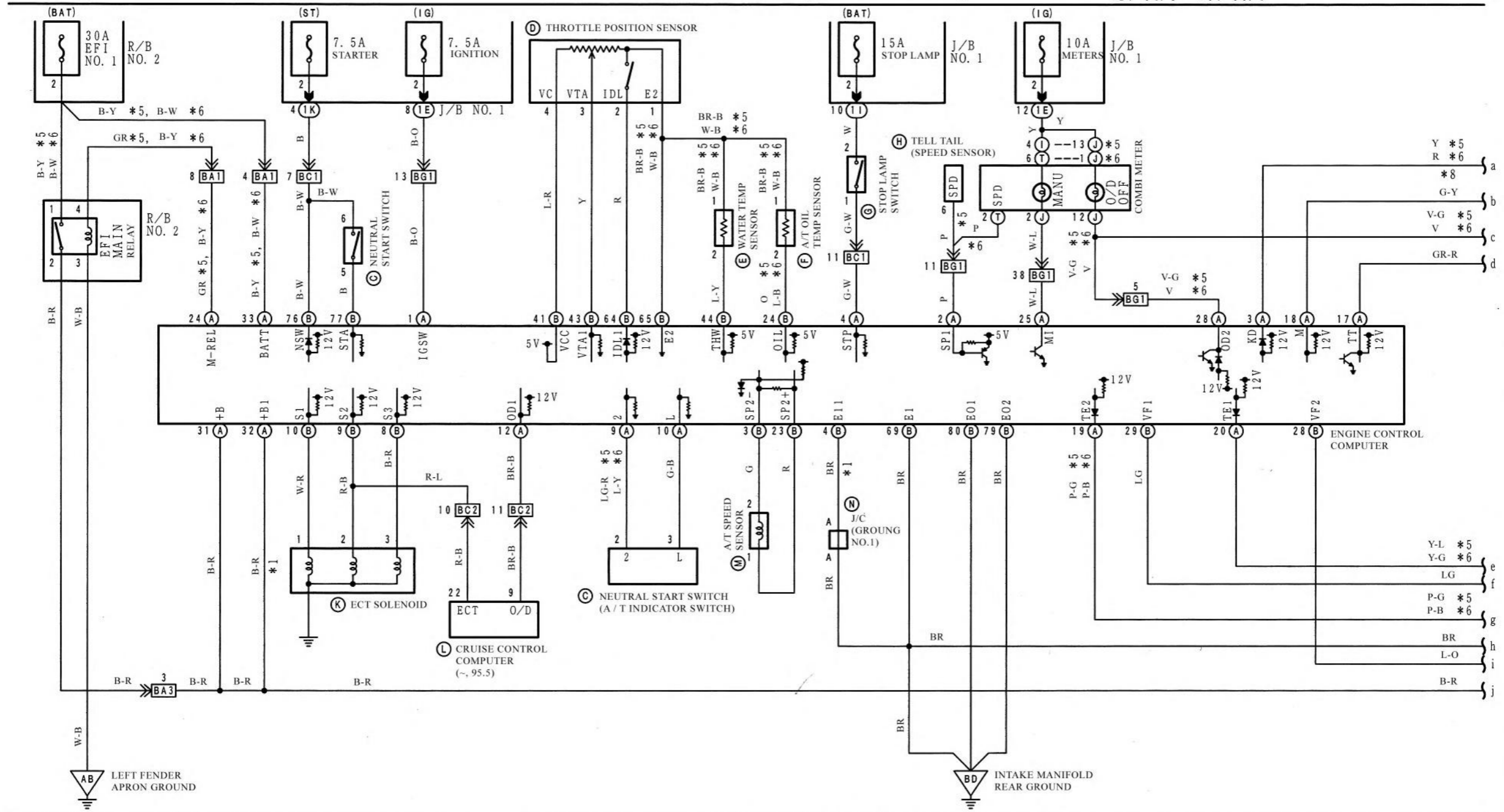

ECT (2JZ-GE)

Door lock

*1: NO MANUAL UNLOCK
 *2: W/MANUAL UNLOCK ~' 96. 4
 *3: ~' 94. 8
 *4: ' 94. 8 ~
 *5: ~' 96. 4
 *6: ' 96. 4 ~

*1: ~' 94. 8
 *3: ~' 95. 5
 *5: ~' 96. 4
 *6: ~' 96. 4 ~
 *7: ~' 95. 5 ~, 96. 4
 *8: ~' 97. 8 ~

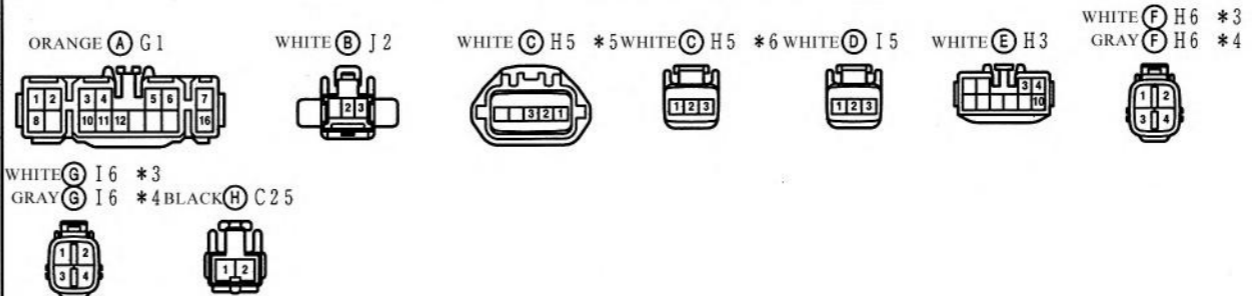
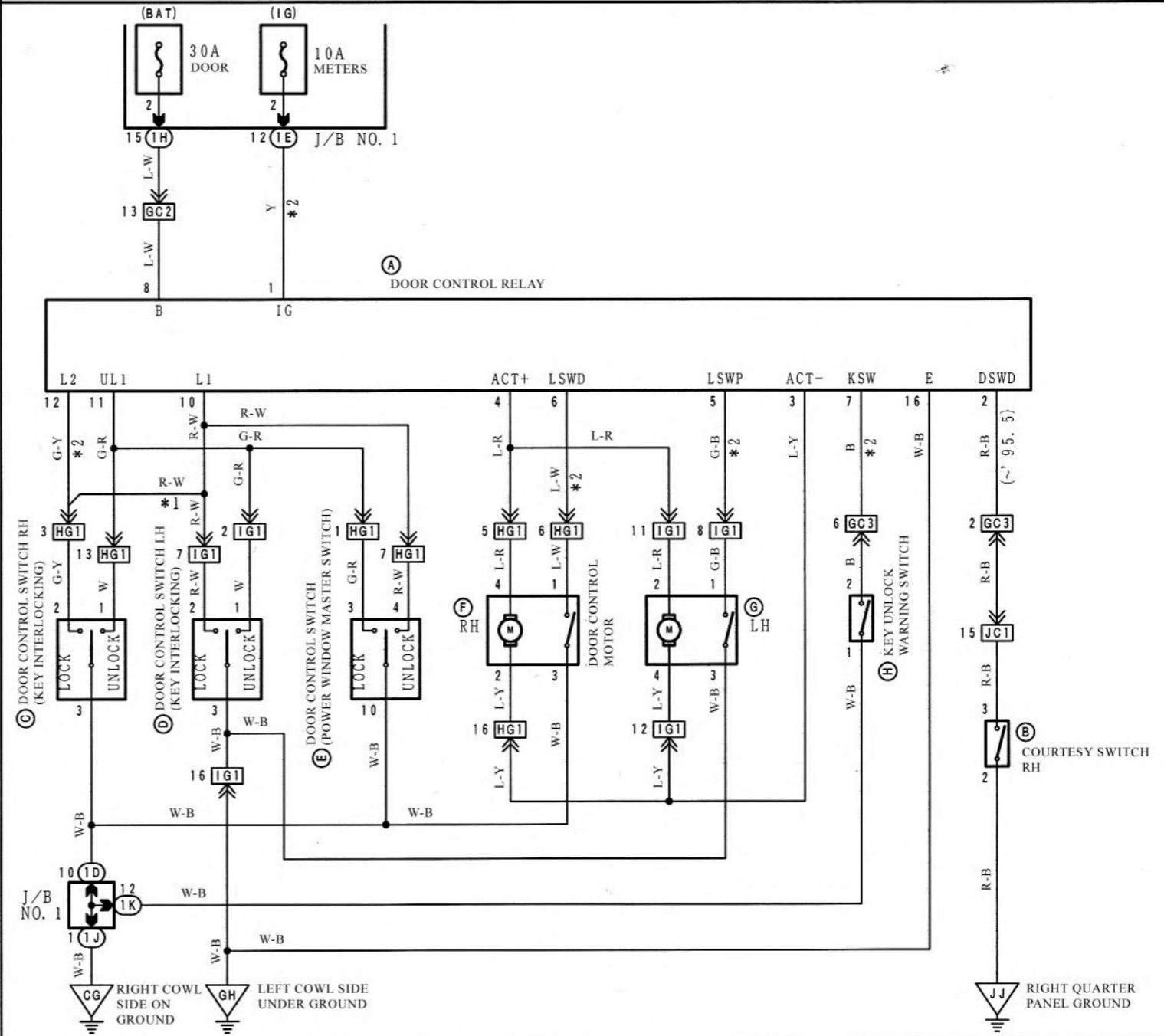
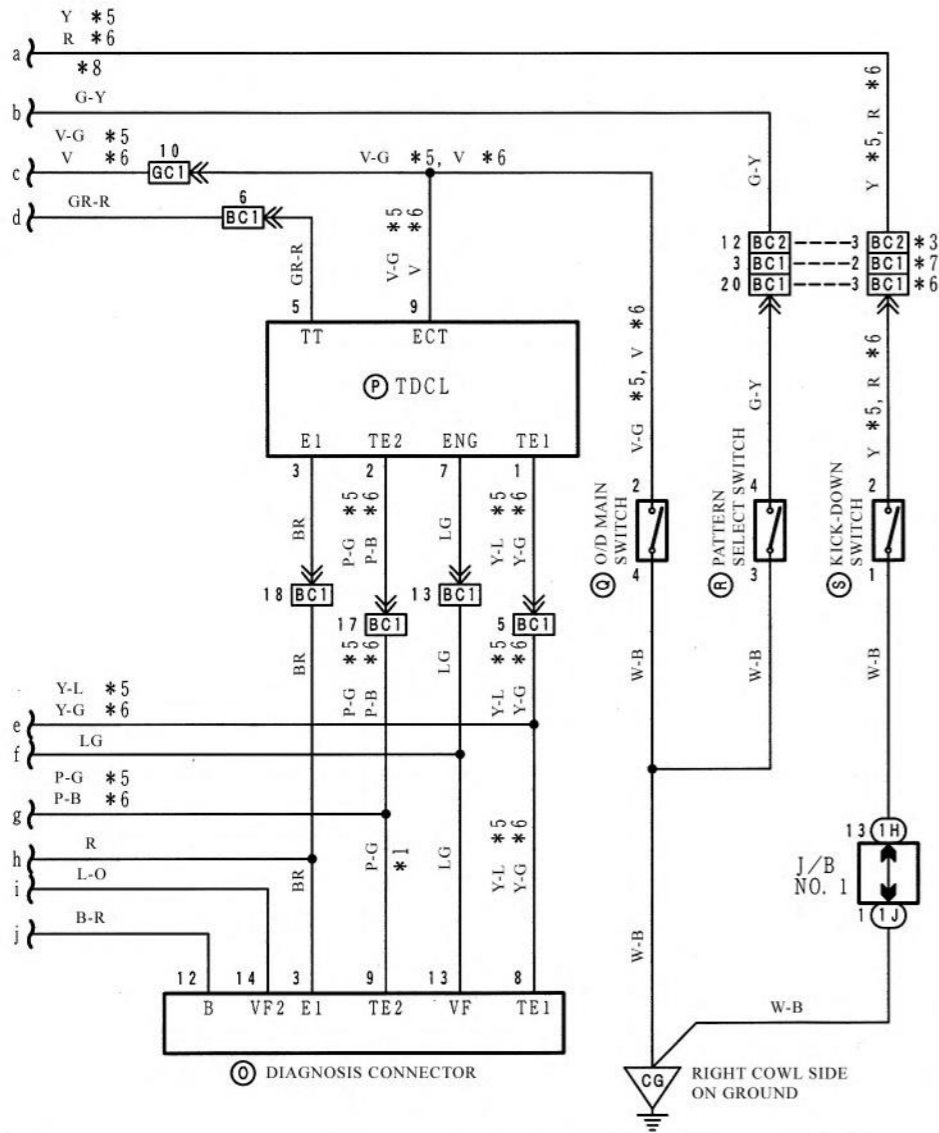

ABS (~ '9 6. 4)

*1: 2JZ-GE *3: ~ 94.8 *5: ~ 95.5
 *2: 2JZ-GTE *4: 94.8 *6: 95.5

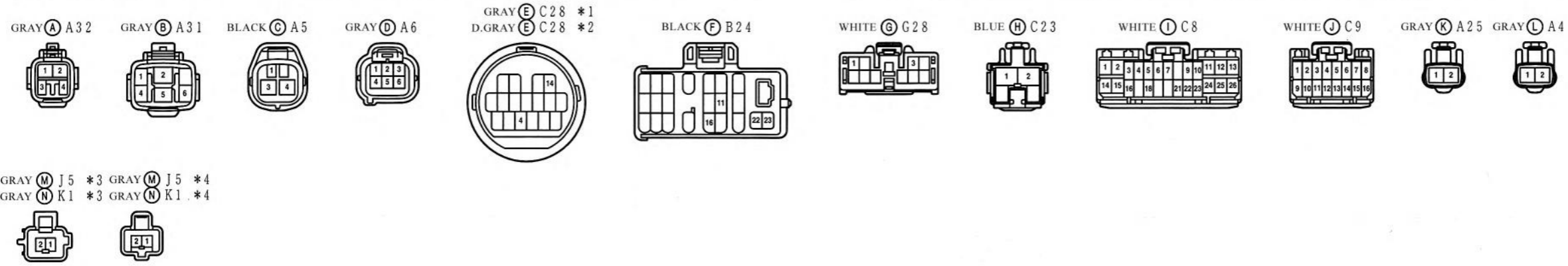
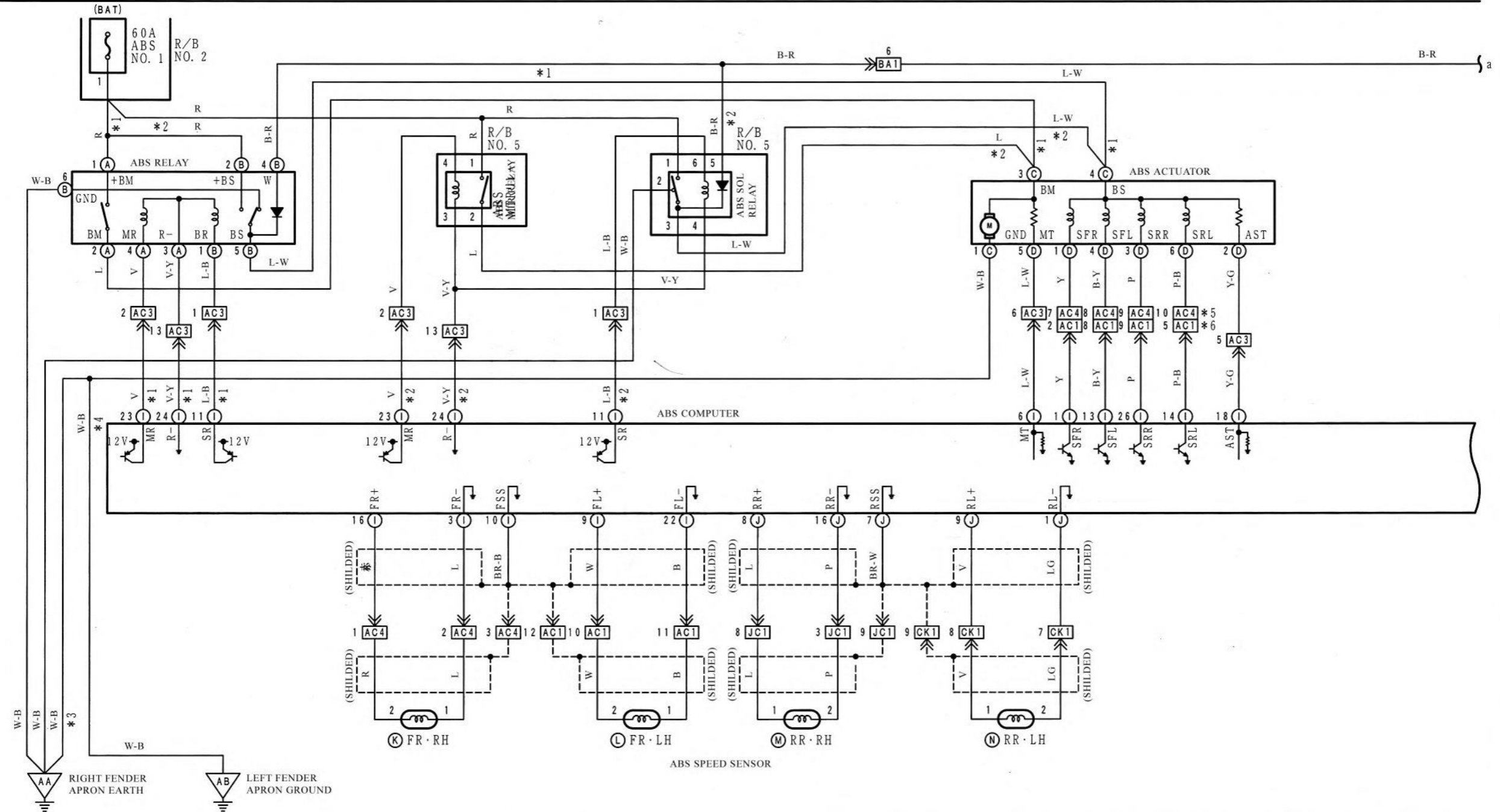

ABS (~, 9 6. 4)

*2:2JZ-GTE

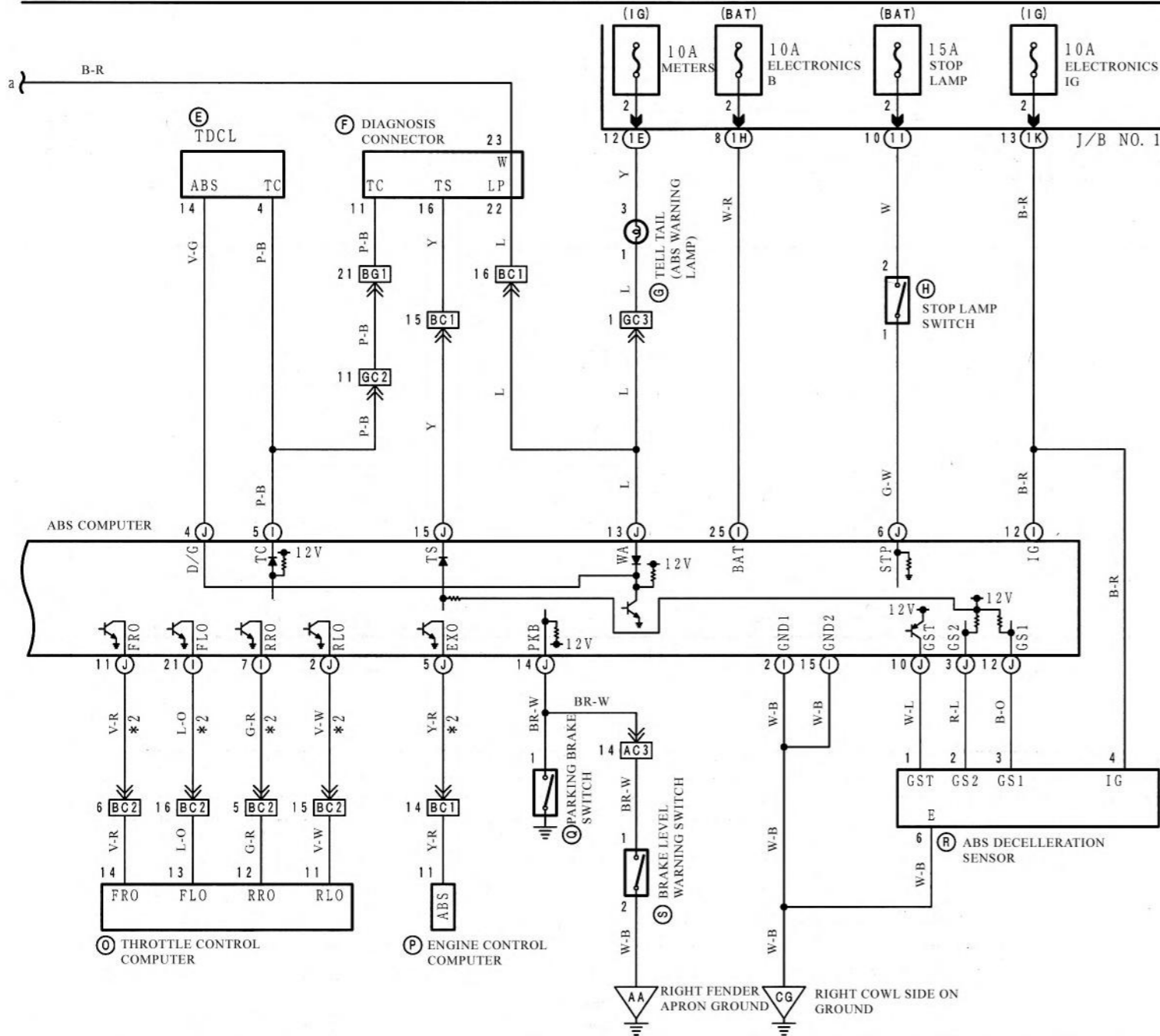

Horn

*1:~'97.8
*2:~'97.8~

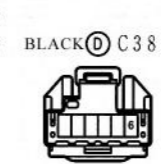
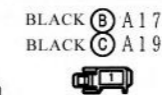
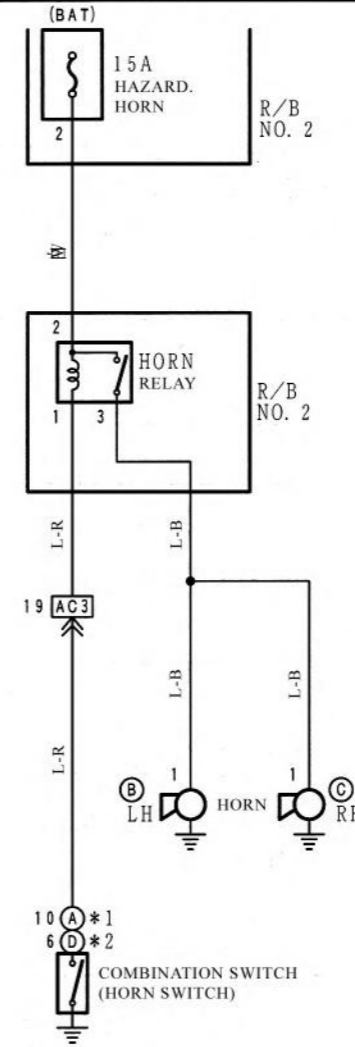

ABS (, 96.4 ~)

*1: 2JZ-GE *3: NO S-ABS *5: '97.8 *8: '97.8~02JZ-GTE
 *2: 2JZ-GTE *4: S-ABS *6: '97.8~ *9: '97.802JZ-GTE

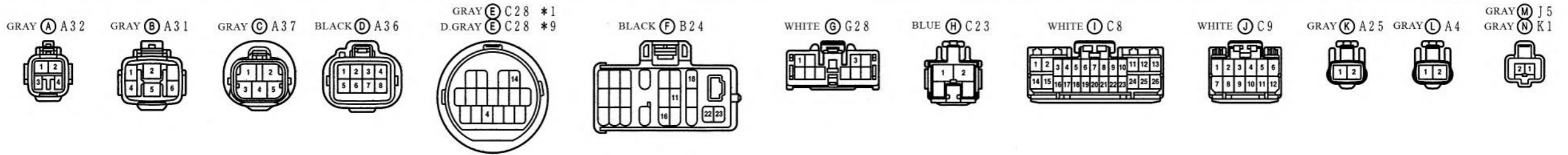
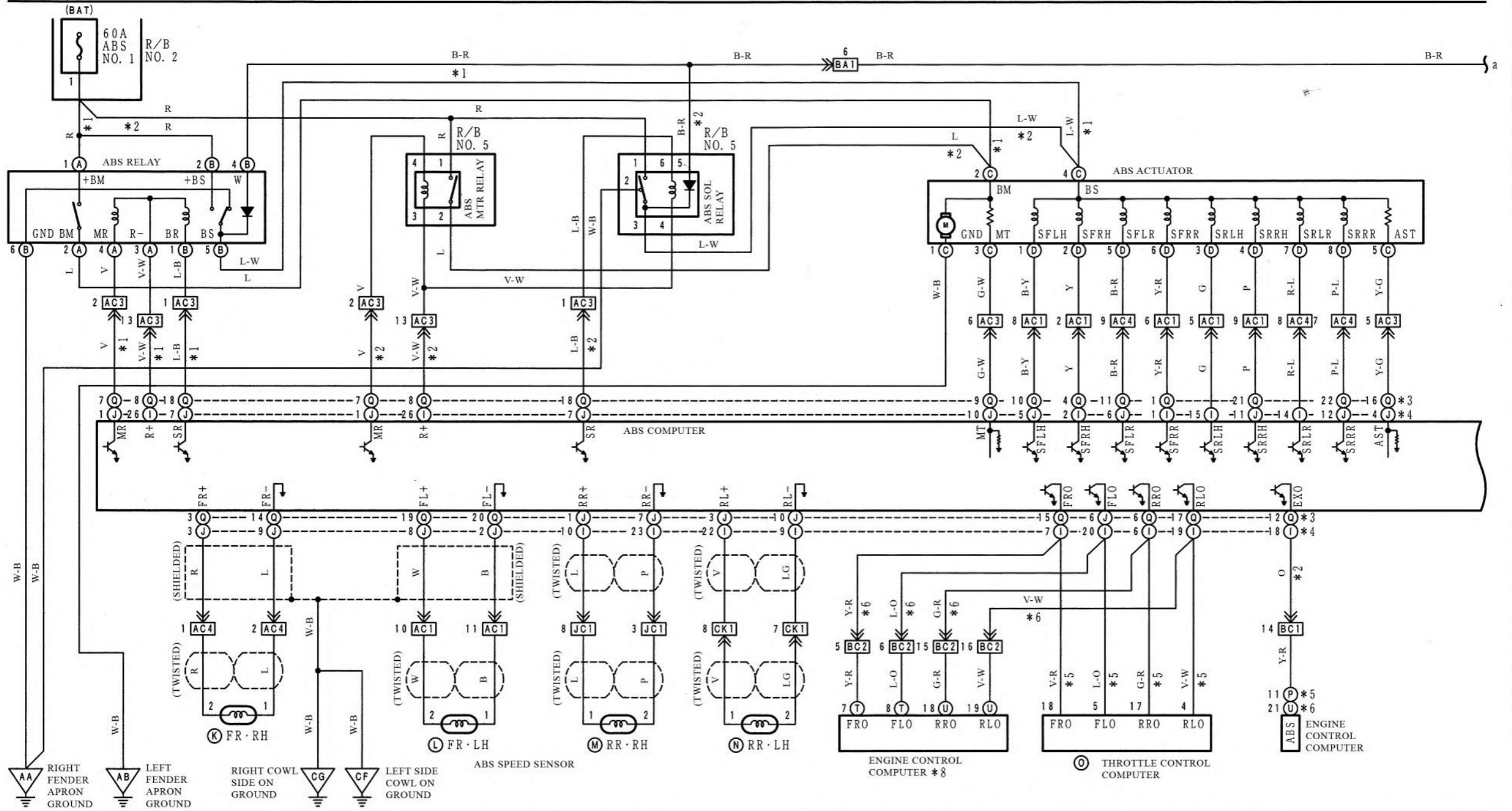

ABS (, 96.4 ~)

*1: 2JZ-GE *4: S-ABS *7: EX' 97.8~の2JZ-GTE
 *2: 2JZ-GTE *5: '97.8 *8: '97.8~の2JZ-GTE
 *3: EX. S-ABS *6: '97.8~

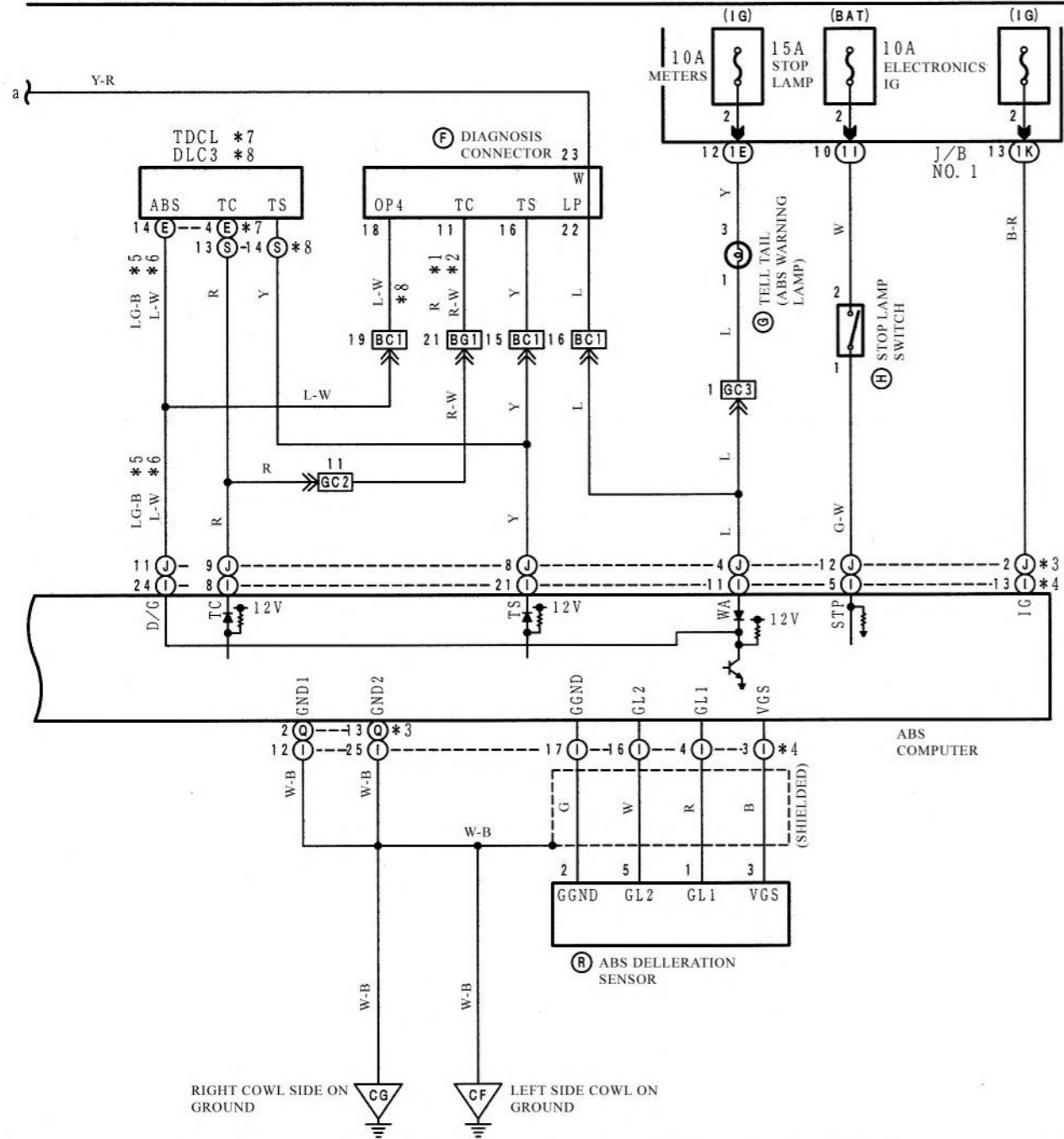

Shift indicator (except 2JZ-GTE '97.8 ~)

*1: '96.4
 *2: '96.4~

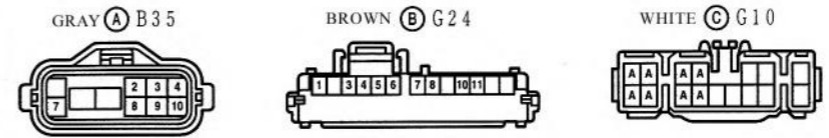
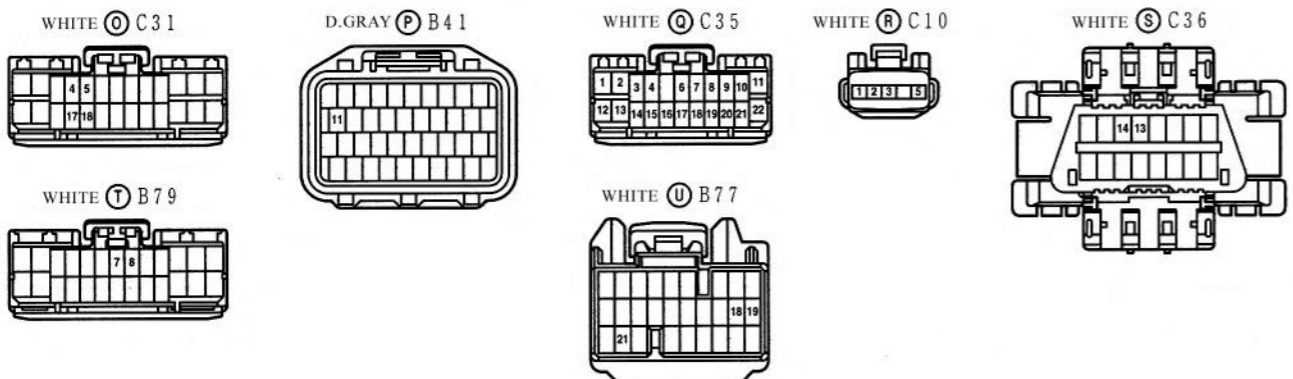
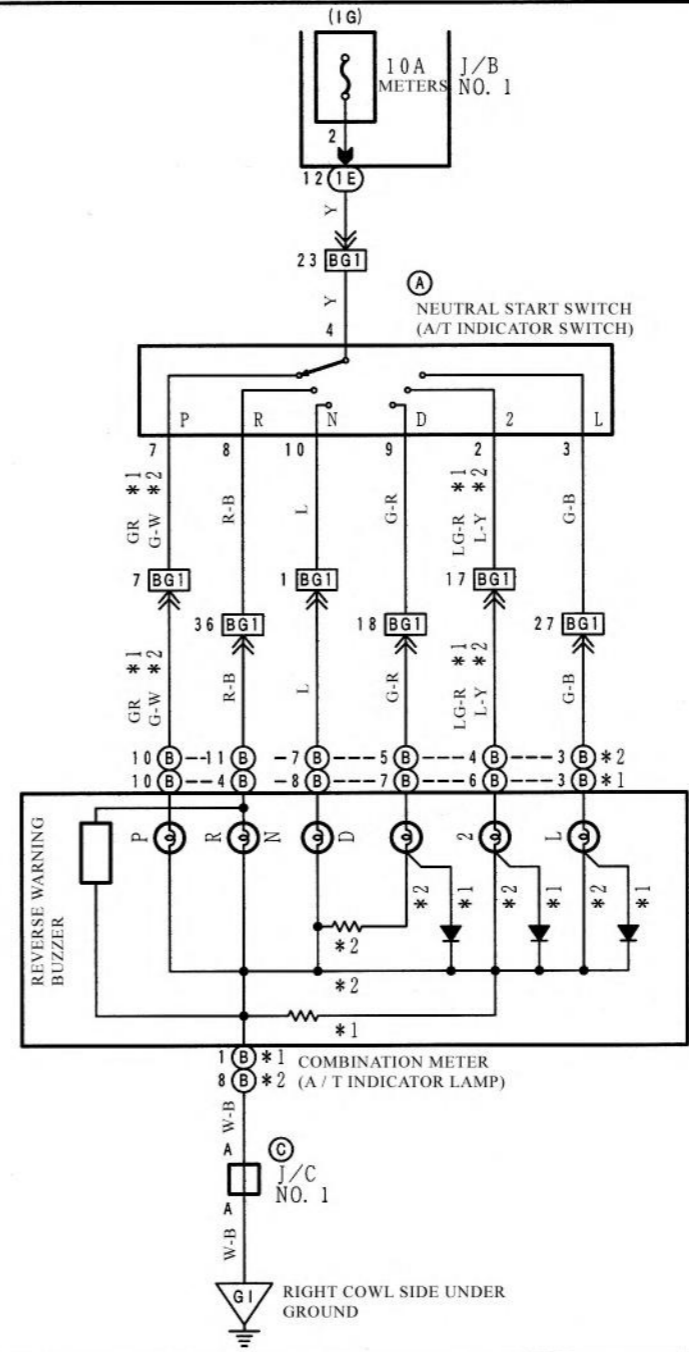

TRC (~, 9 6. 4)

*1: ~ 94. 8

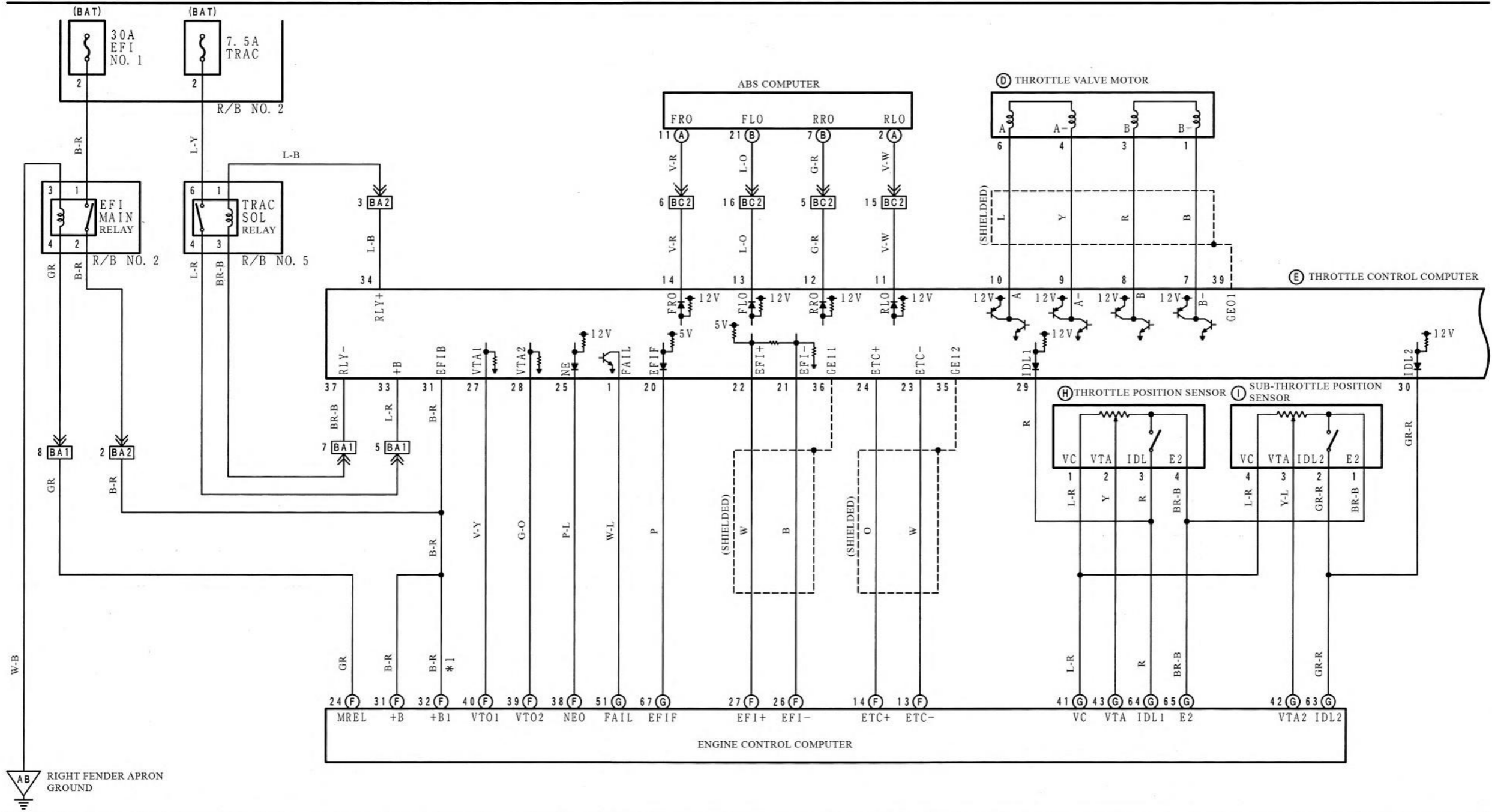

TRC (~, 96.4)

*1: ~ 94.8
*2: ~ 94.8~

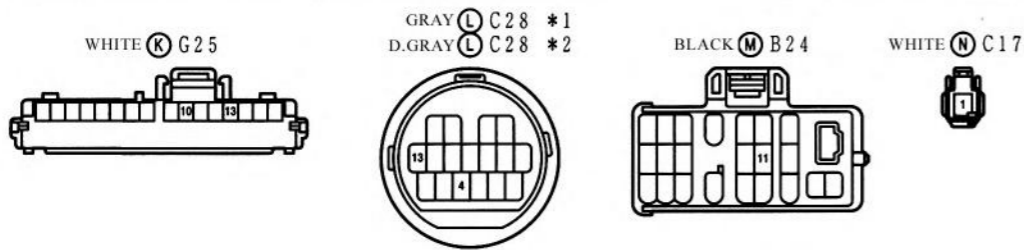
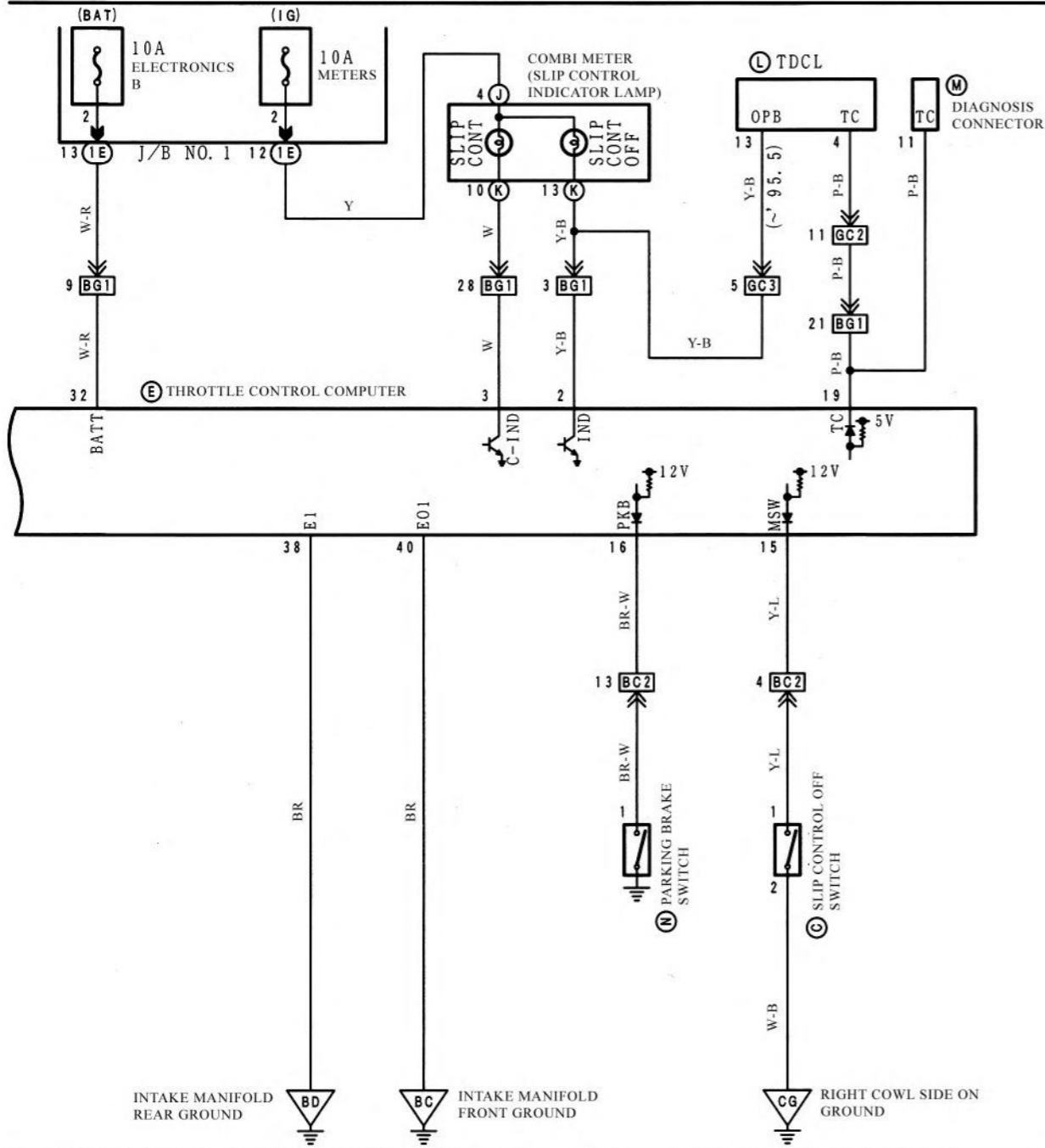

Seat belt warning & tension reducer

*1: ~ 97.8
*2: ~ 97.8~

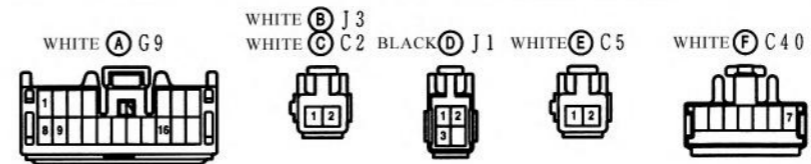
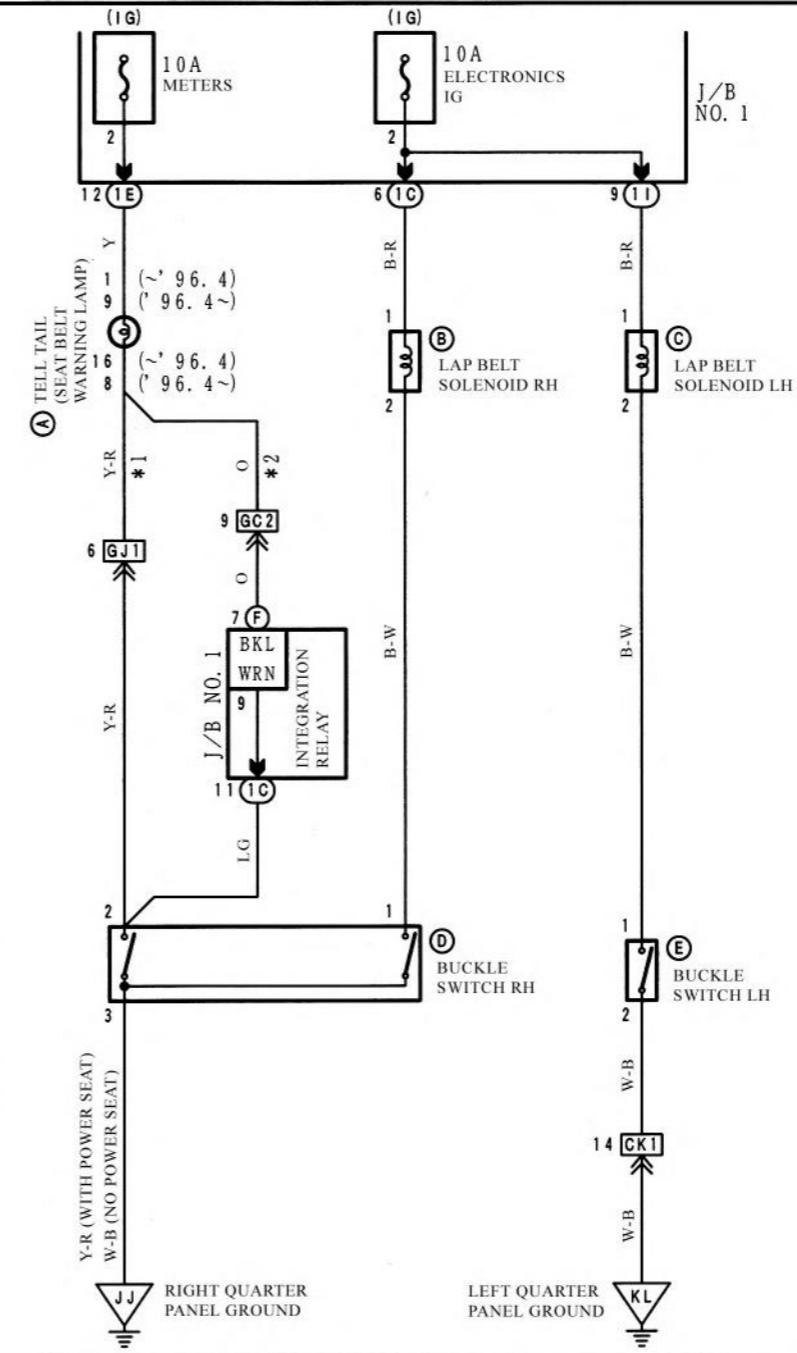

TRC ('96.4 ~ '97.8)

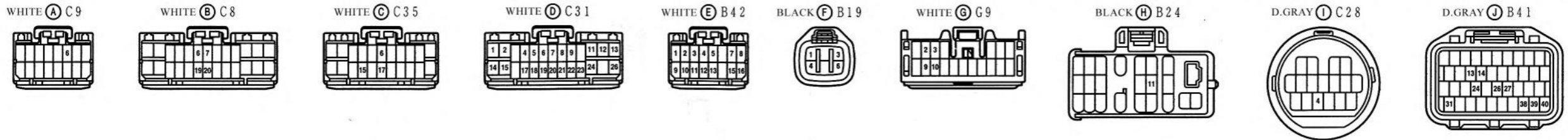
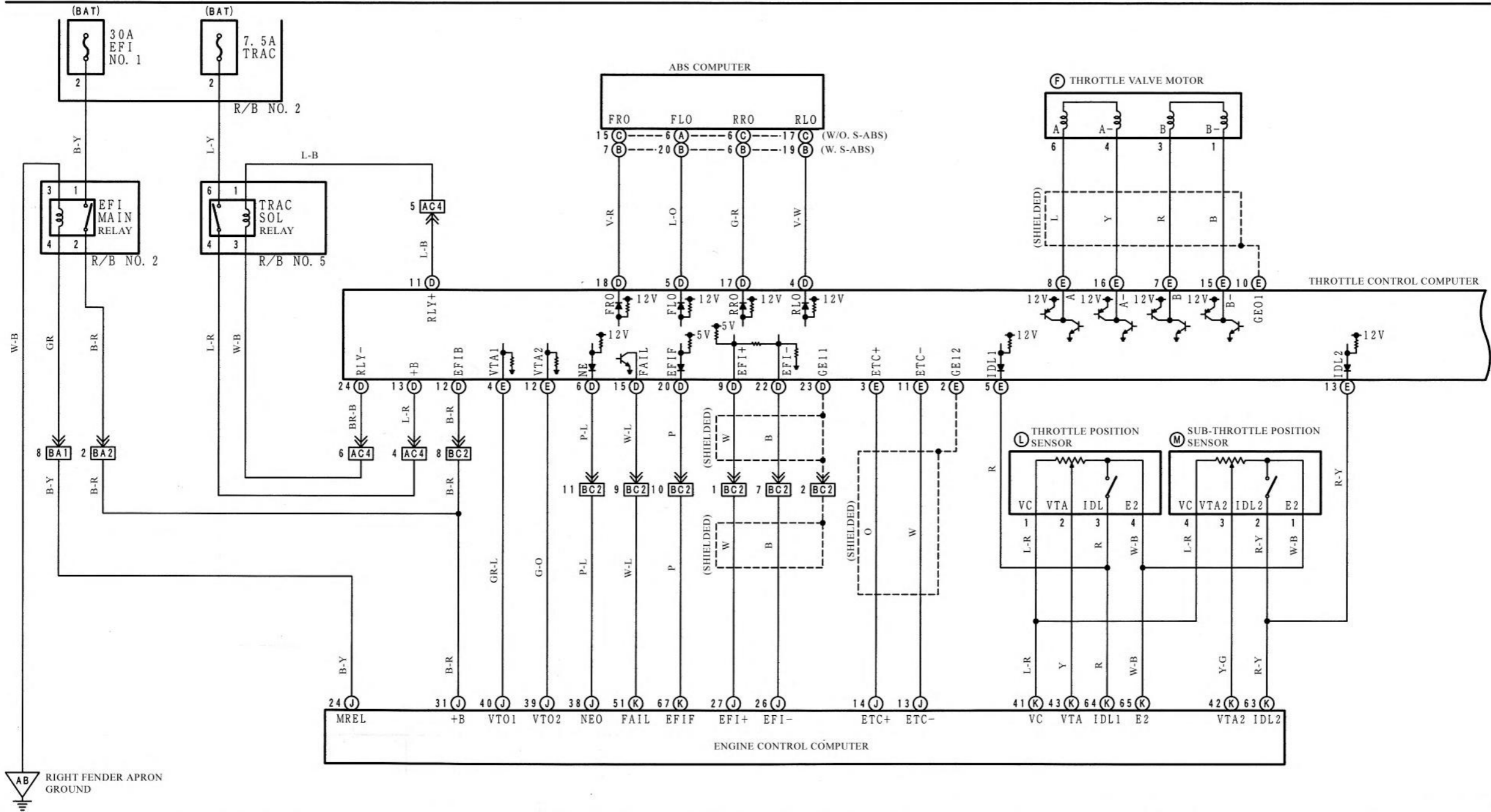

TRC ('96.4 ~ '97.8)

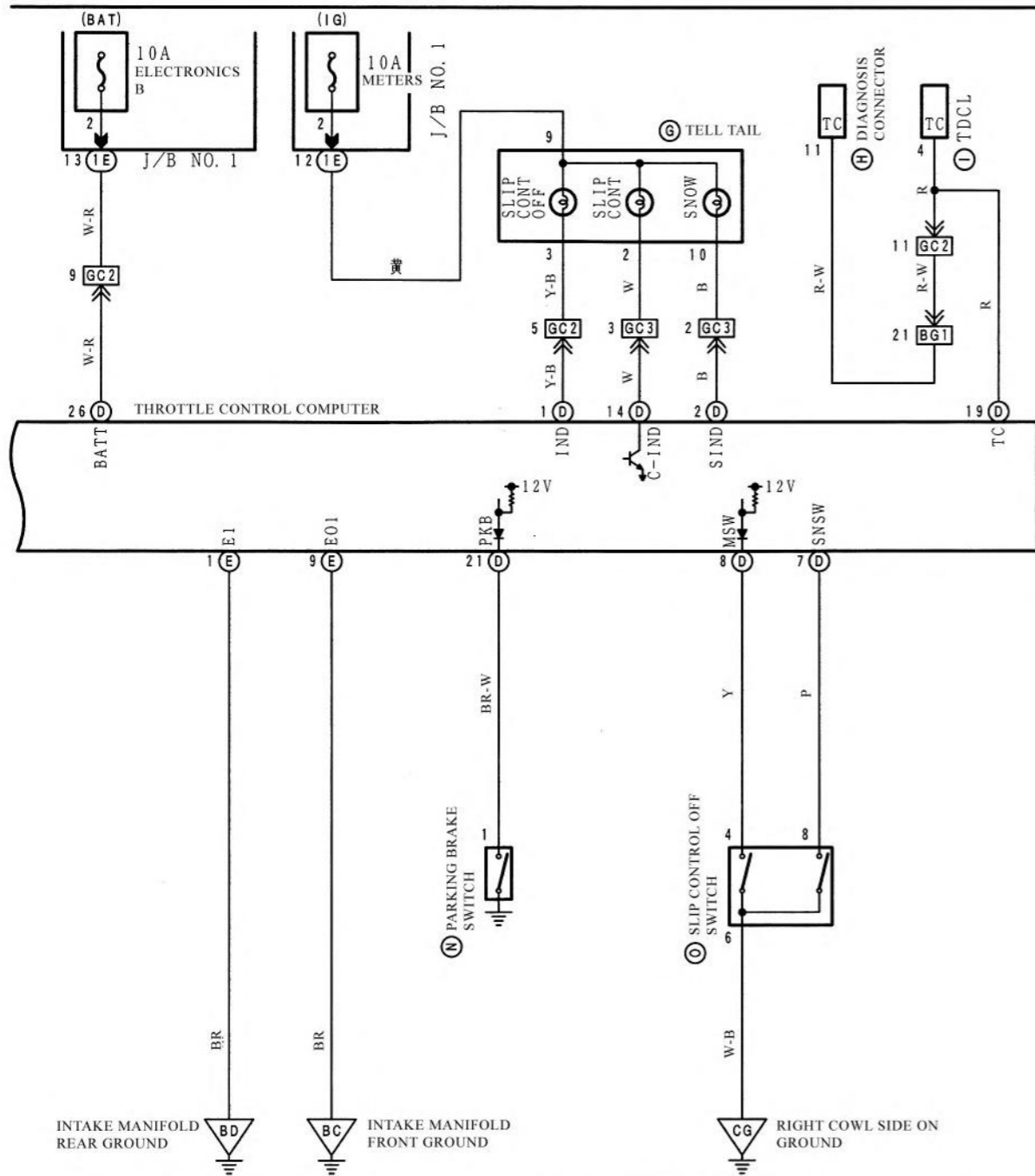

Rear window defogger & mirror heater

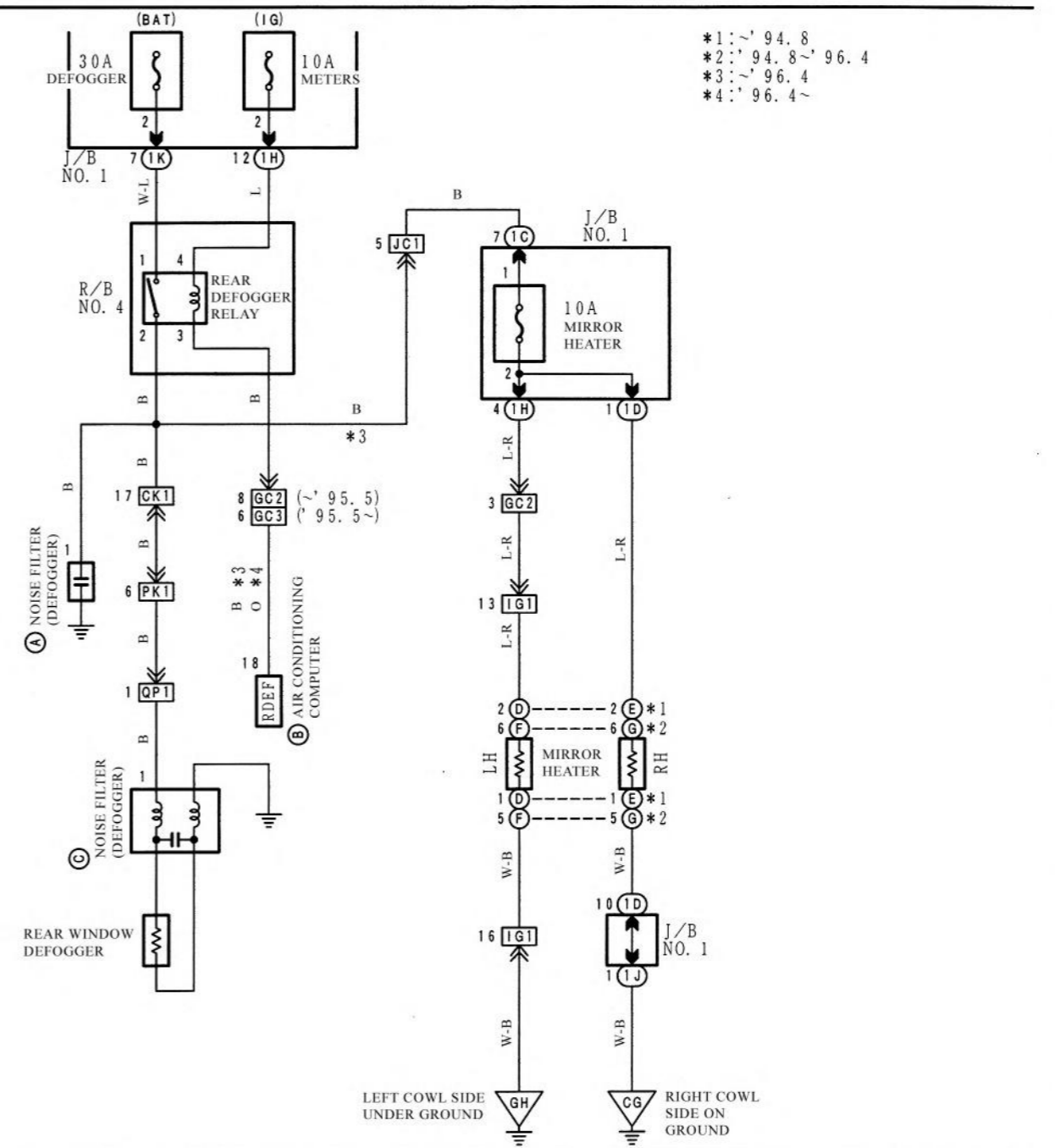

*1: '94.8
 *2: '94.8 ~ '96.4
 *3: '96.4
 *4: '96.4 ~

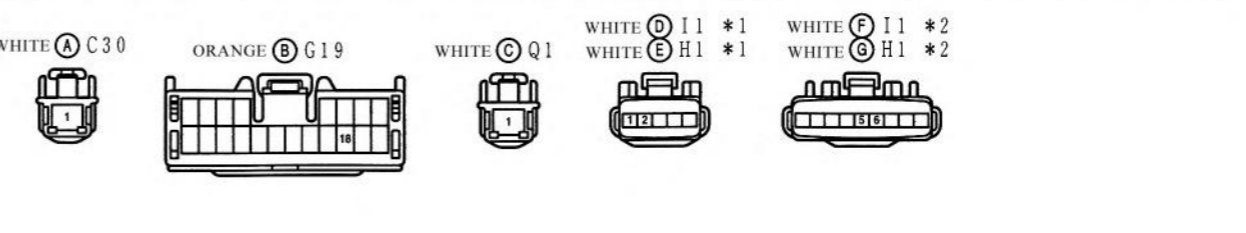
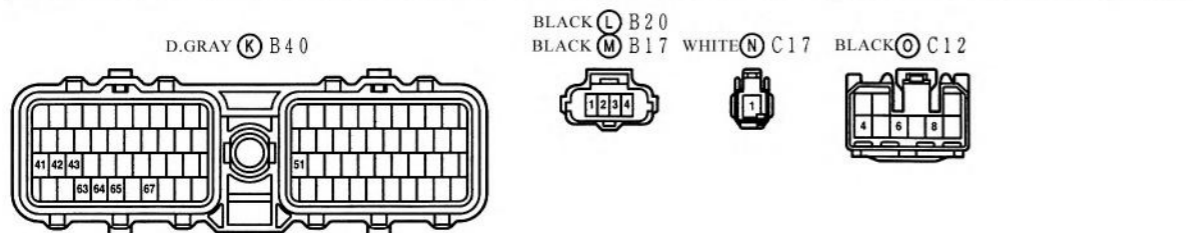

Air bag

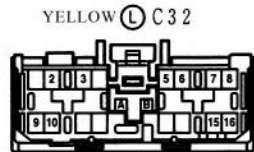
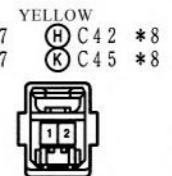
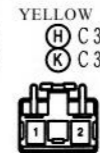
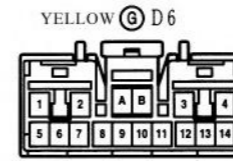
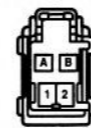
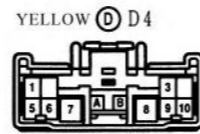
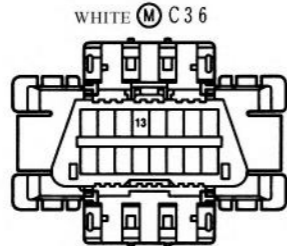
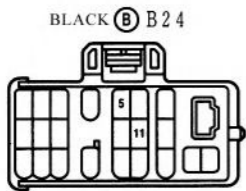
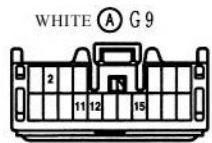
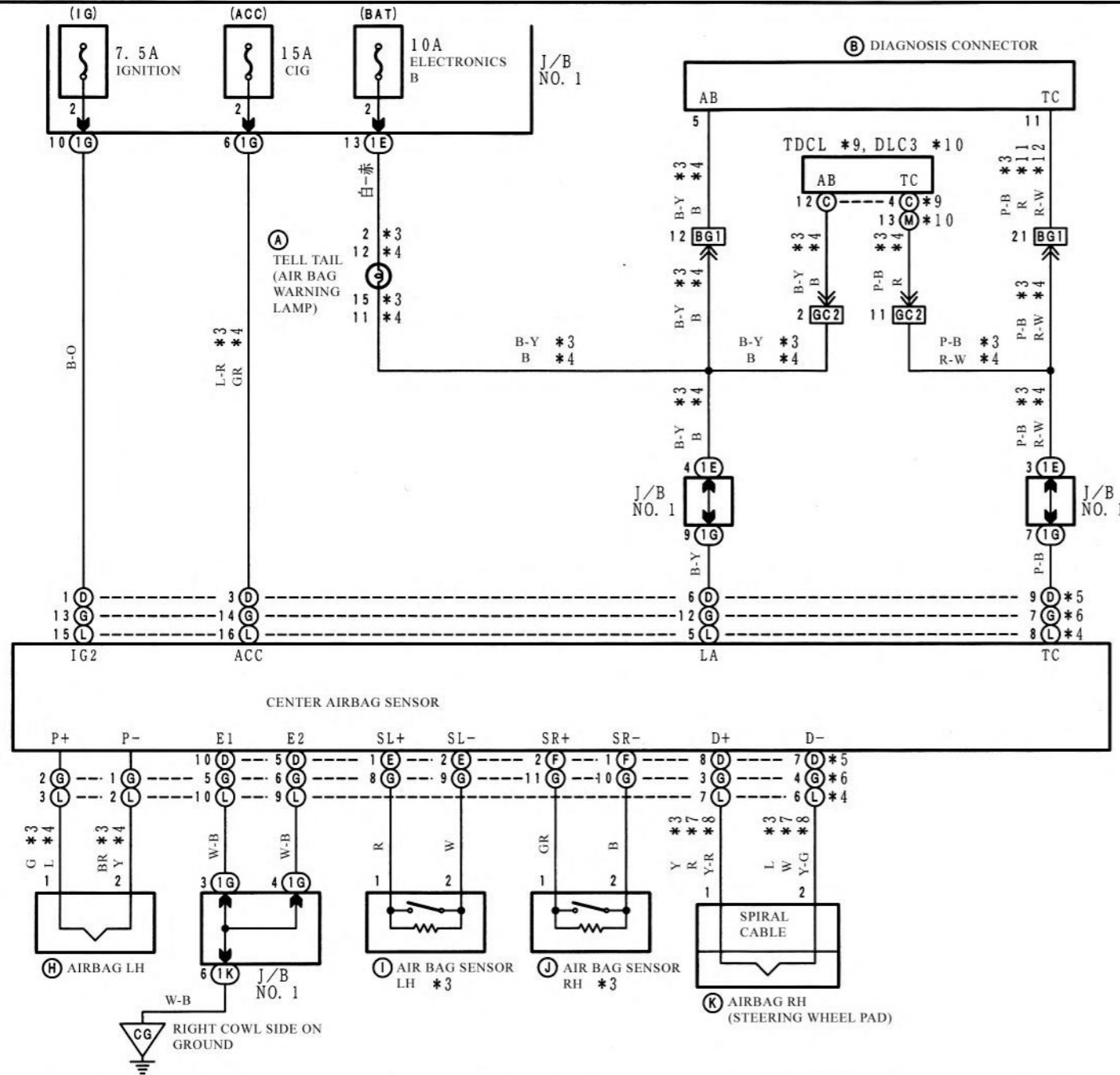

Audio (Super Live Sound System)

*1: 94.8 *3: 96.4 *5: 97.8
 *2: 94.8 *4: 96.4 *6: 97.8

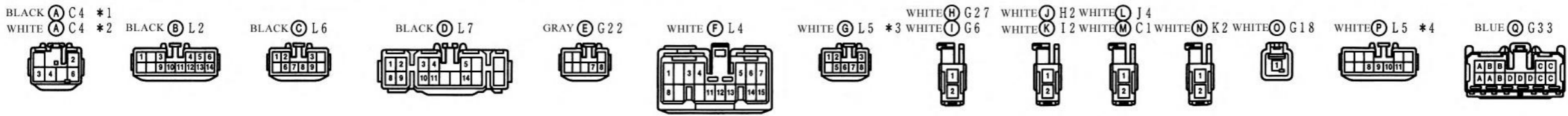
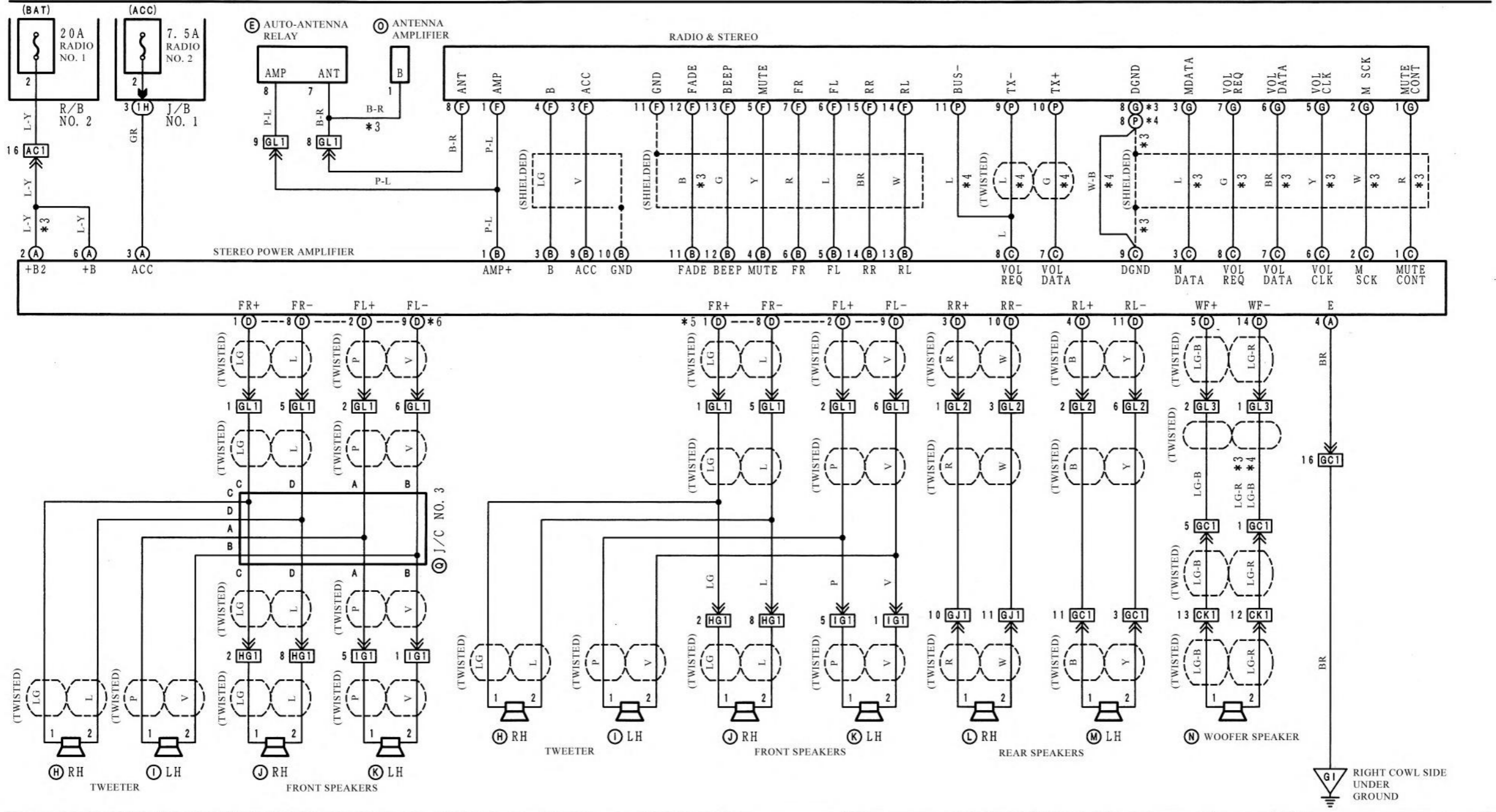

Combination meter (~' 9 6.4)

*1: 2JZ-GE *3: ~' 94. 8
*2: 2JZ-GTE *4: ' 94. 8~

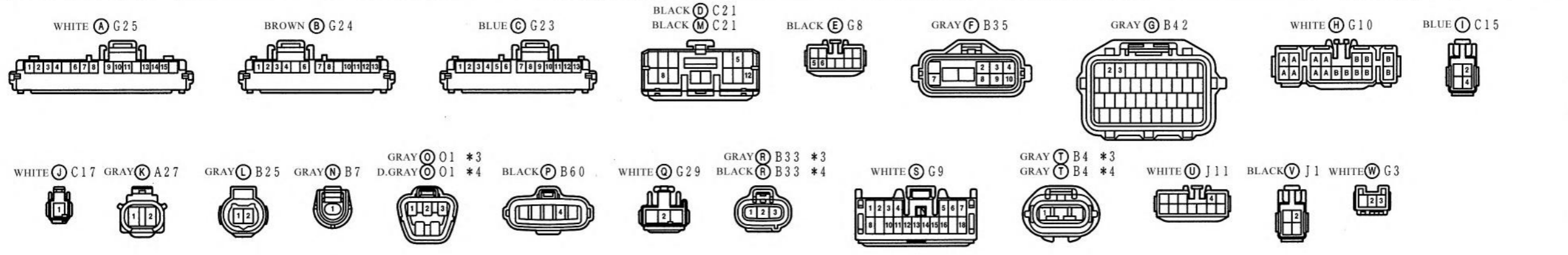
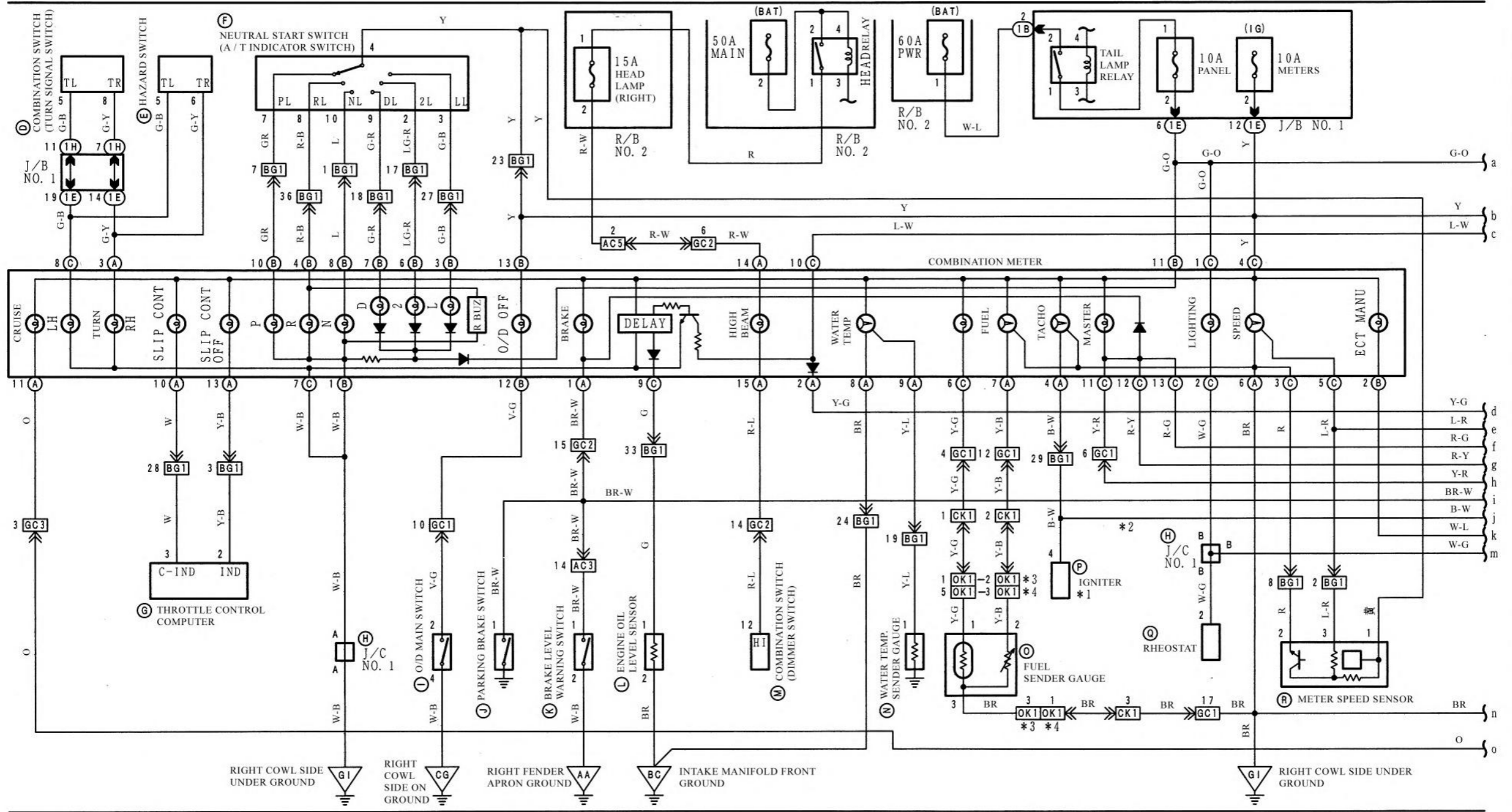

Combination meter (~ '96.4)

*1: 2JZ-GE *3: ~'94.8
*2: 2JZ-GTE *4: '94.8~

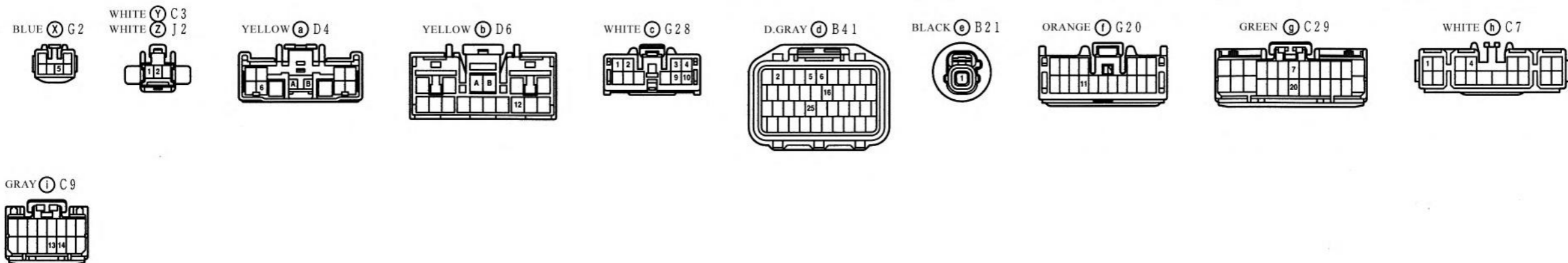
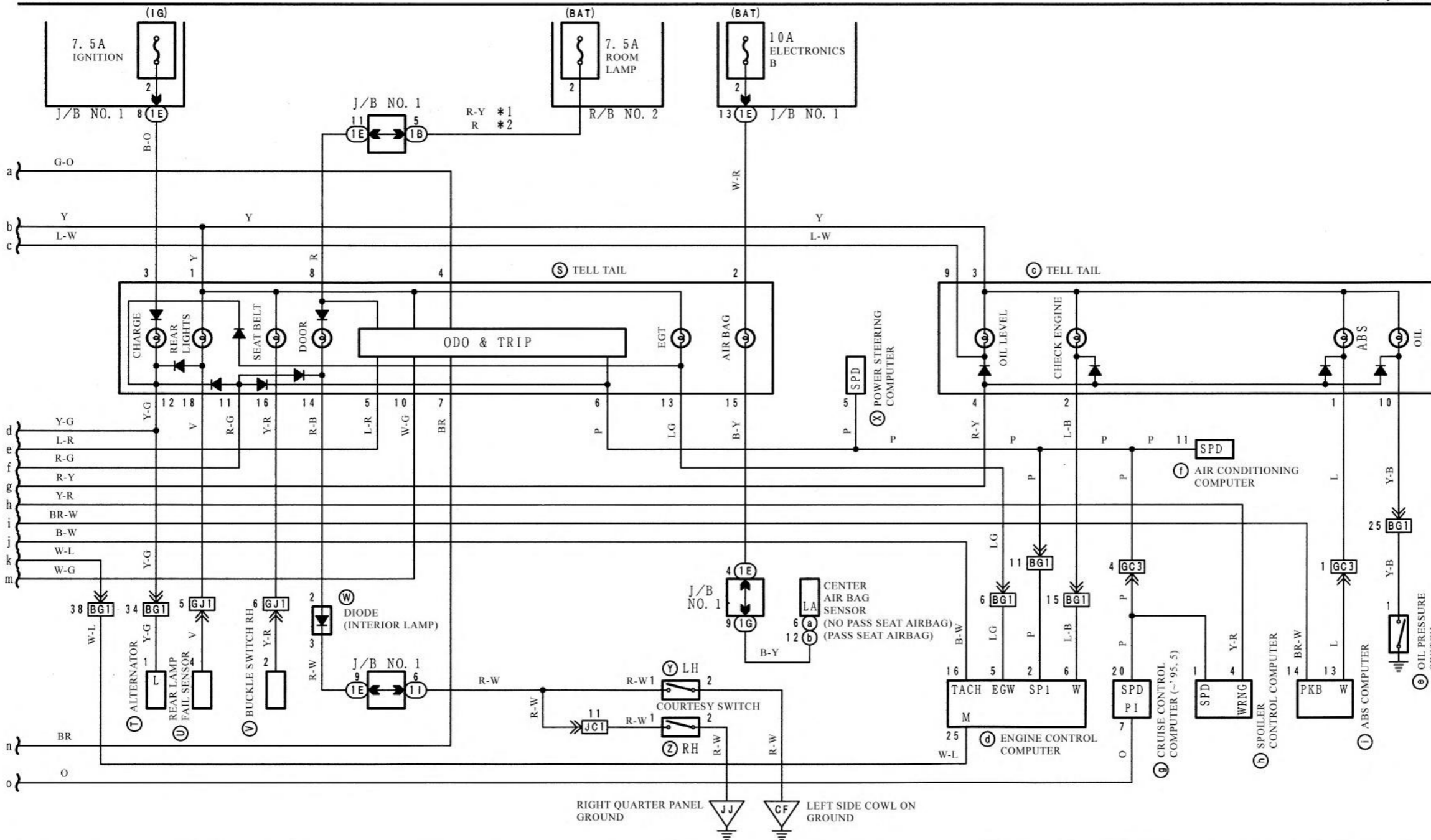

Power steering

*1:~'94.8 *3:~'96.4
*2:~'94.8~ *4:~'96.4~

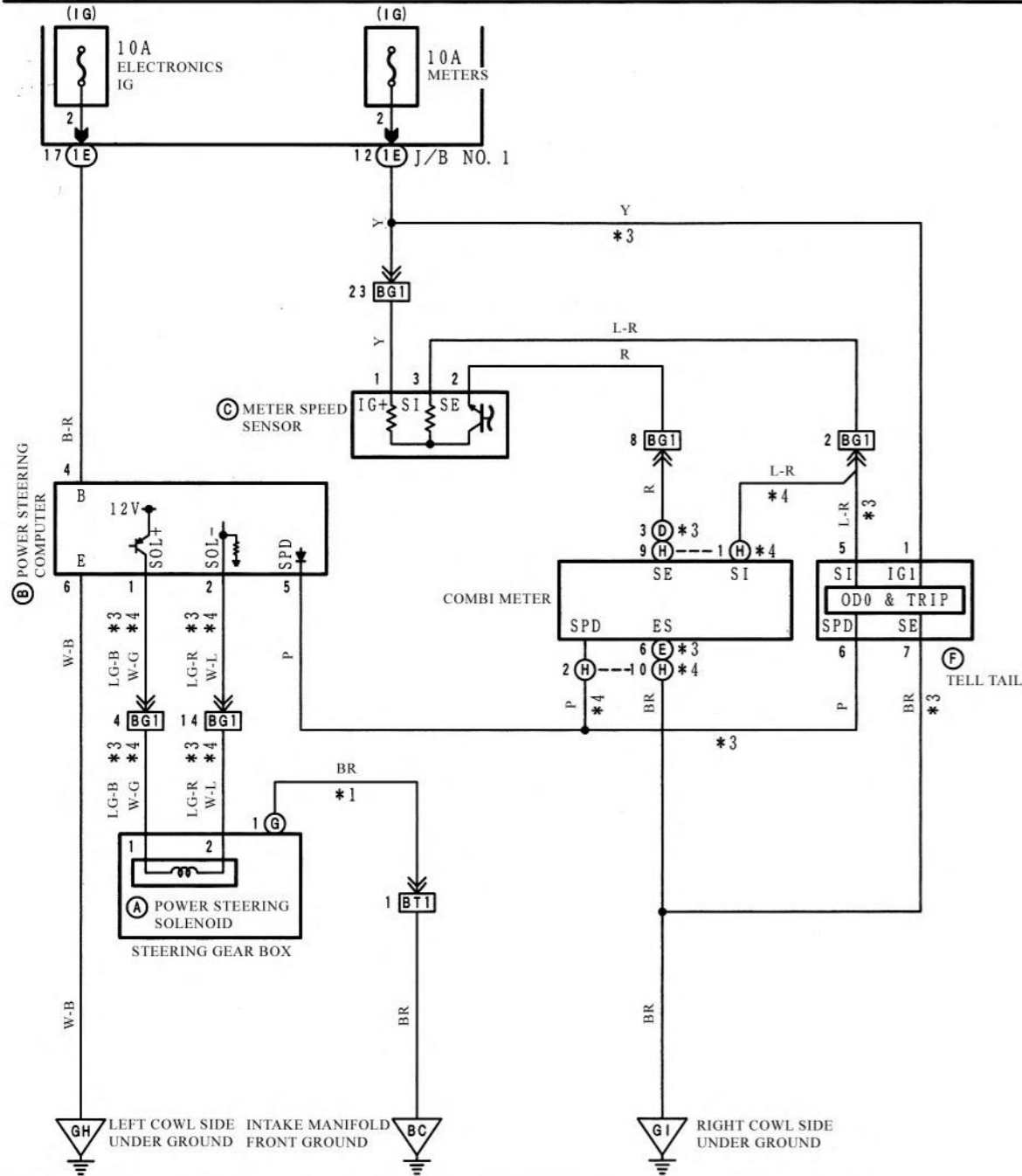

Ground

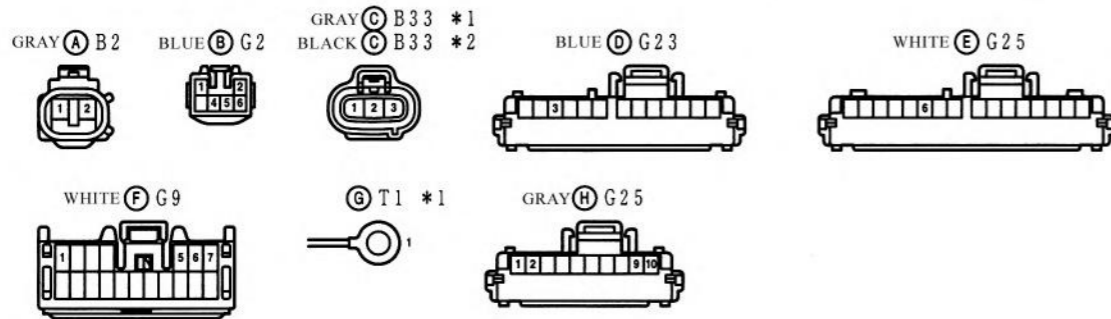
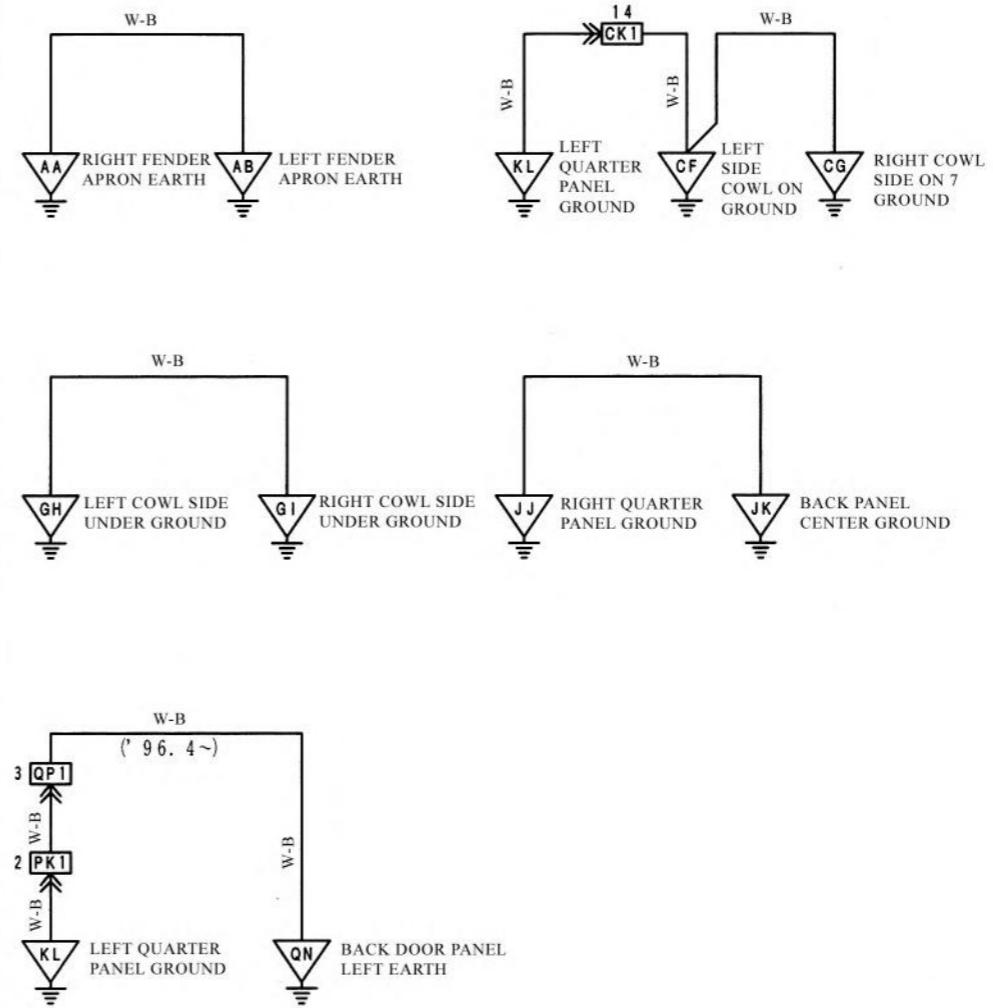

Antenna motor

*1: POWER AMP *3: ~'94. 8
 *2: W/POWER AMP *4: '94. 8~

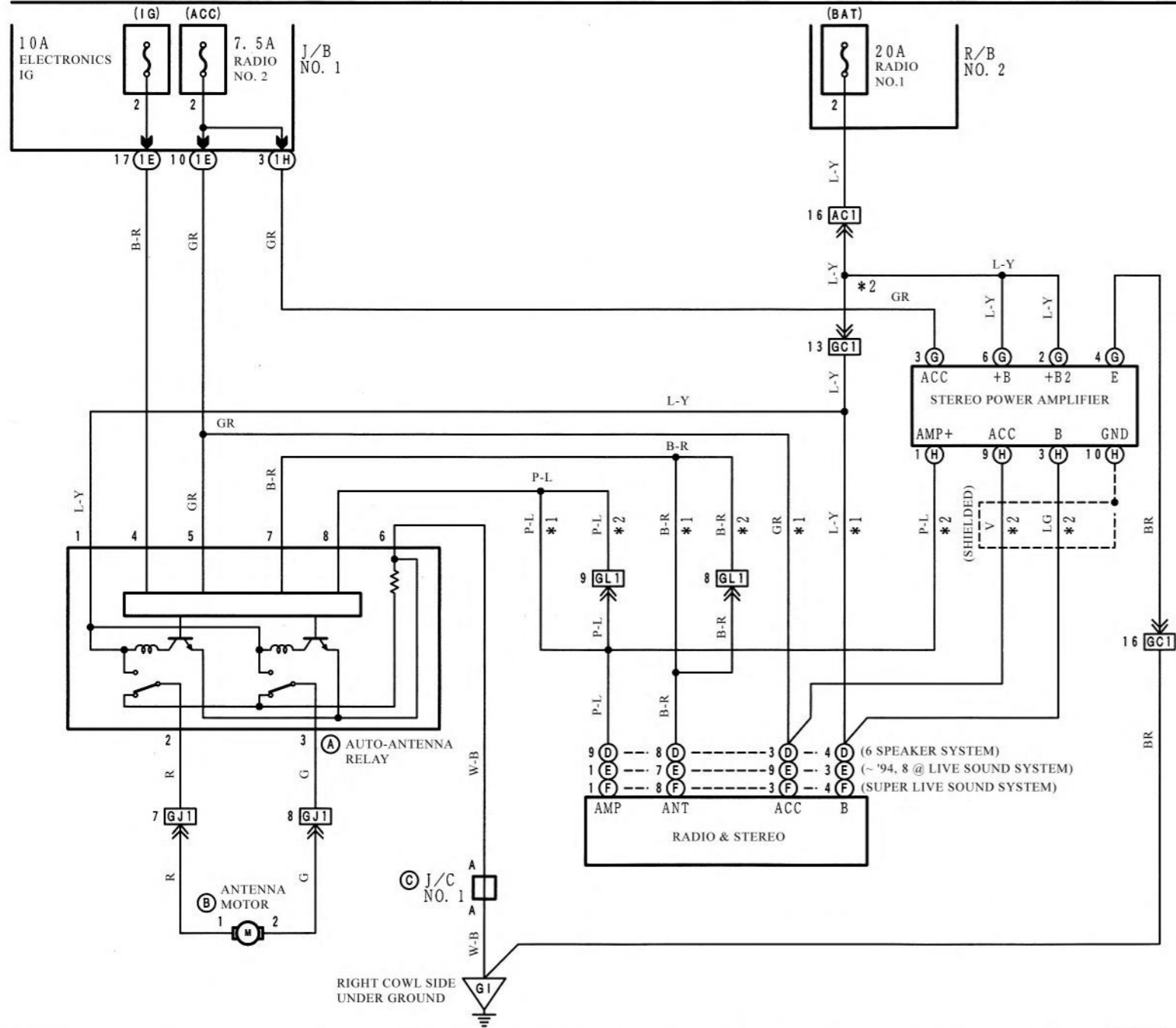

Telephone (~ '96.4)

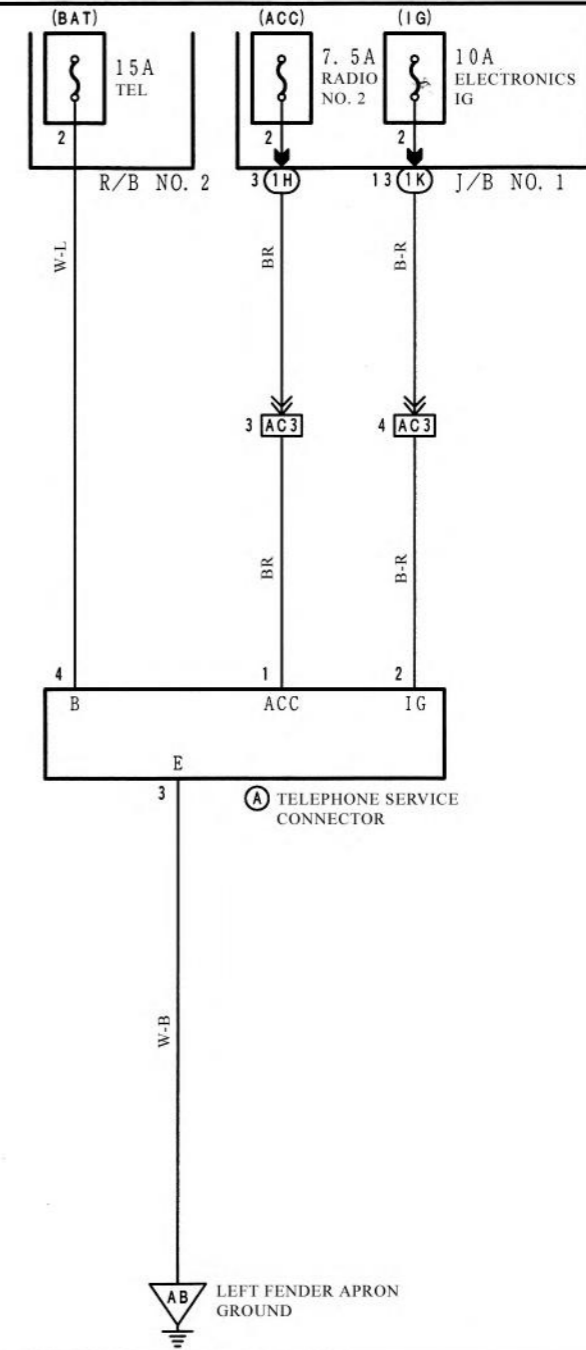

GRAY (A) G22 WHITE (B) J6



WHITE (C) G10



WHITE (D) G30



WHITE (E) L1



WHITE (F) L4



BLACK (G) C4 *3 BLACK (H) L2 *3
 WHITE (G) C4 *4 WHITE (H) L2 *4



WHITE (A) A1



Combination meter ('96.4 ~)

*2: 2JZ-GTE *6: '97. 8~ *8: '97. 8~の2JZ-GTE
 *5: '97. 8 *7: EX'97. 8~の2JZ-GTE

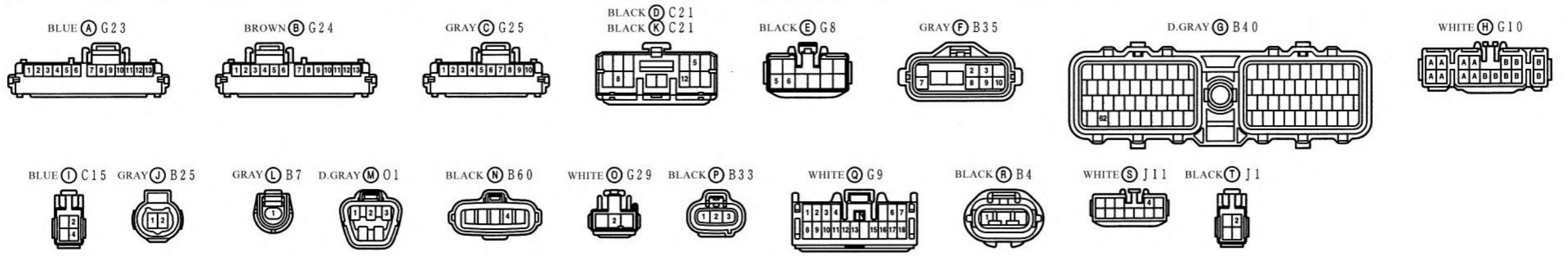
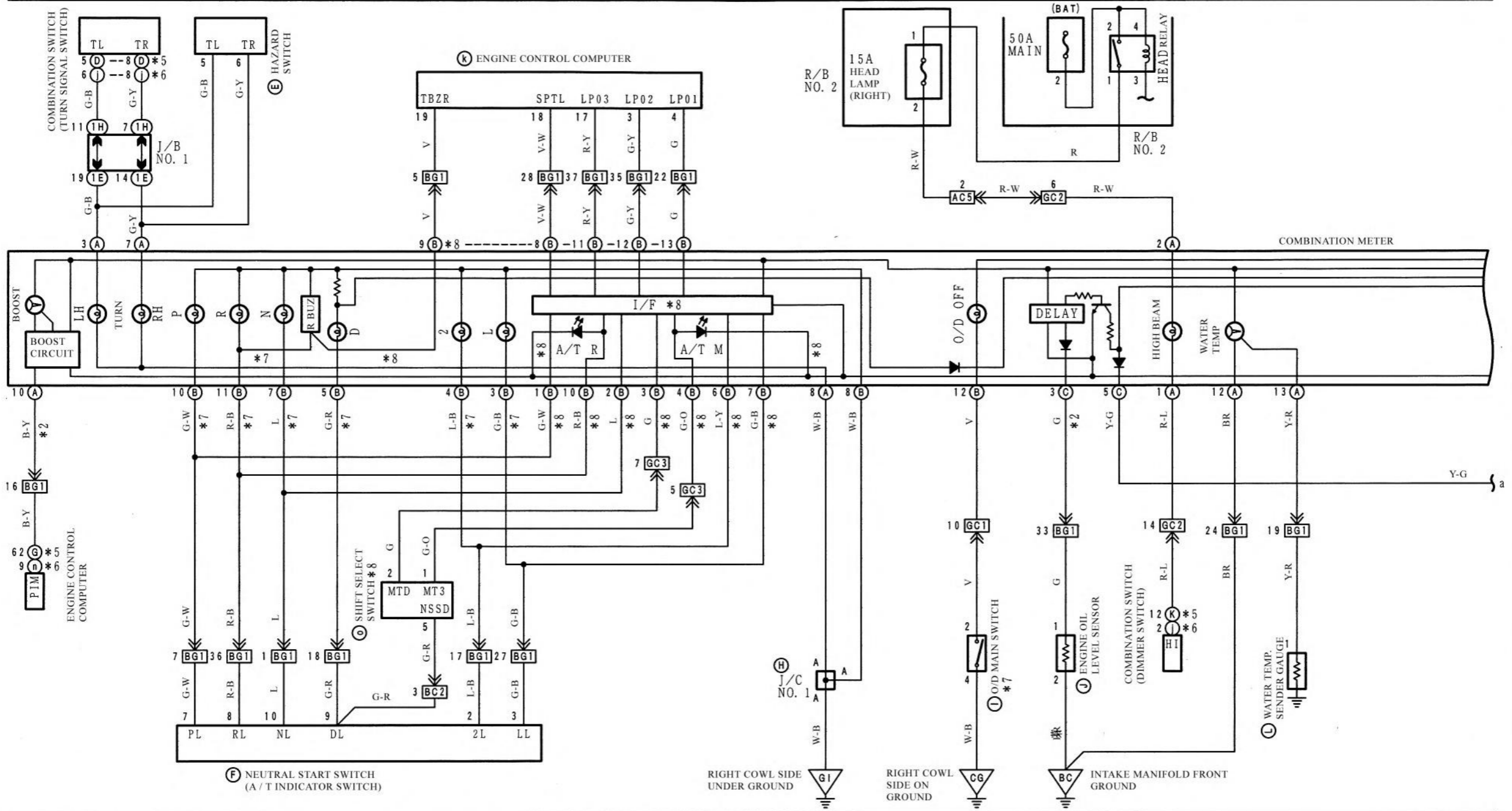

Combination meter ('9 6.4~)

*1: 2JZ-GE *5: '97. 8 *7: EX' 97. 8~の2JZ-GTE
 *2: 2JZ-GTE *6: '97. 8~

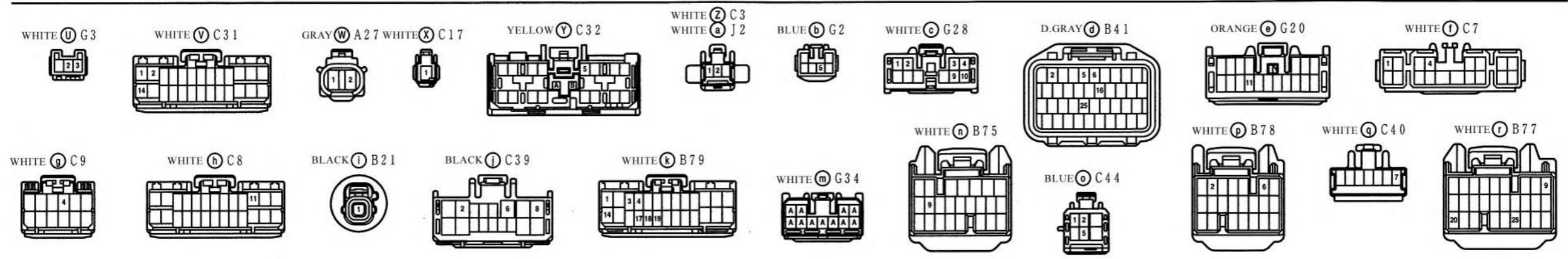
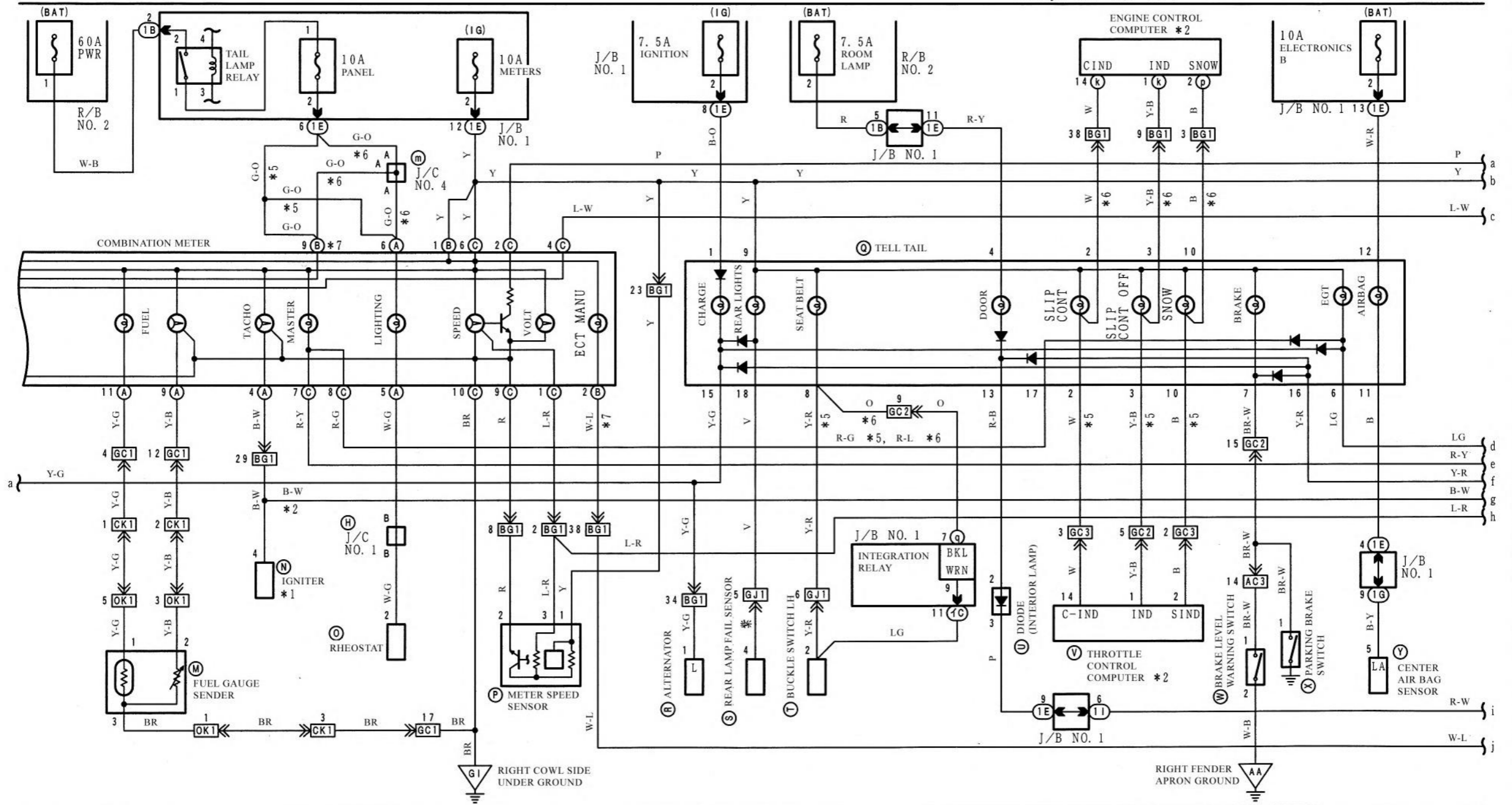

Combination meter ('96, 4 ~)

- *2: 2JZ-GTE
- *3: EX S-ABS
- *4: S-ABS
- *7: EX '97. 8~の2JZ-GTE
- *8: '97. 8~の2JZ-GTE
- *9: '97. 8~の2JZ-GTEのA/T
- *10: EX '97. 8~の2JZ-GTEのA/T
- *11: '97. 8~の2JZ-GE

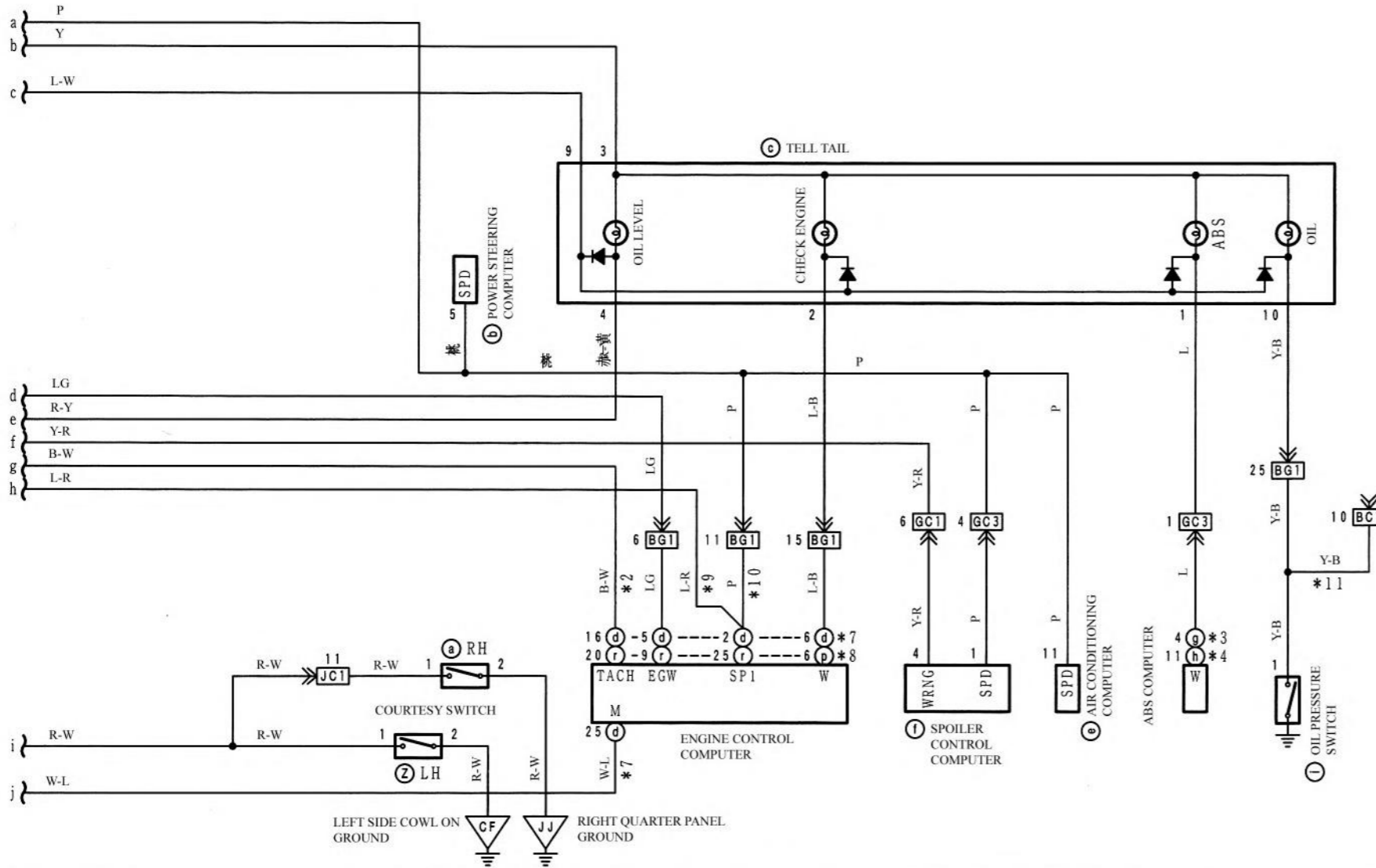

Audio (6 speaker system)

*1: 97.8
*2: 97.8~

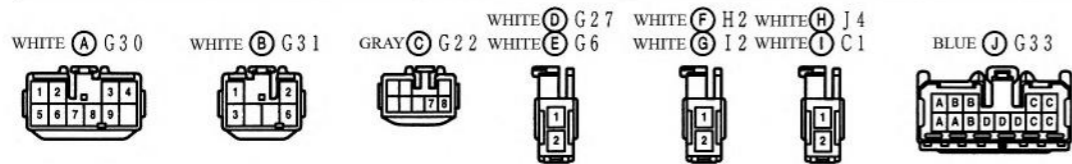
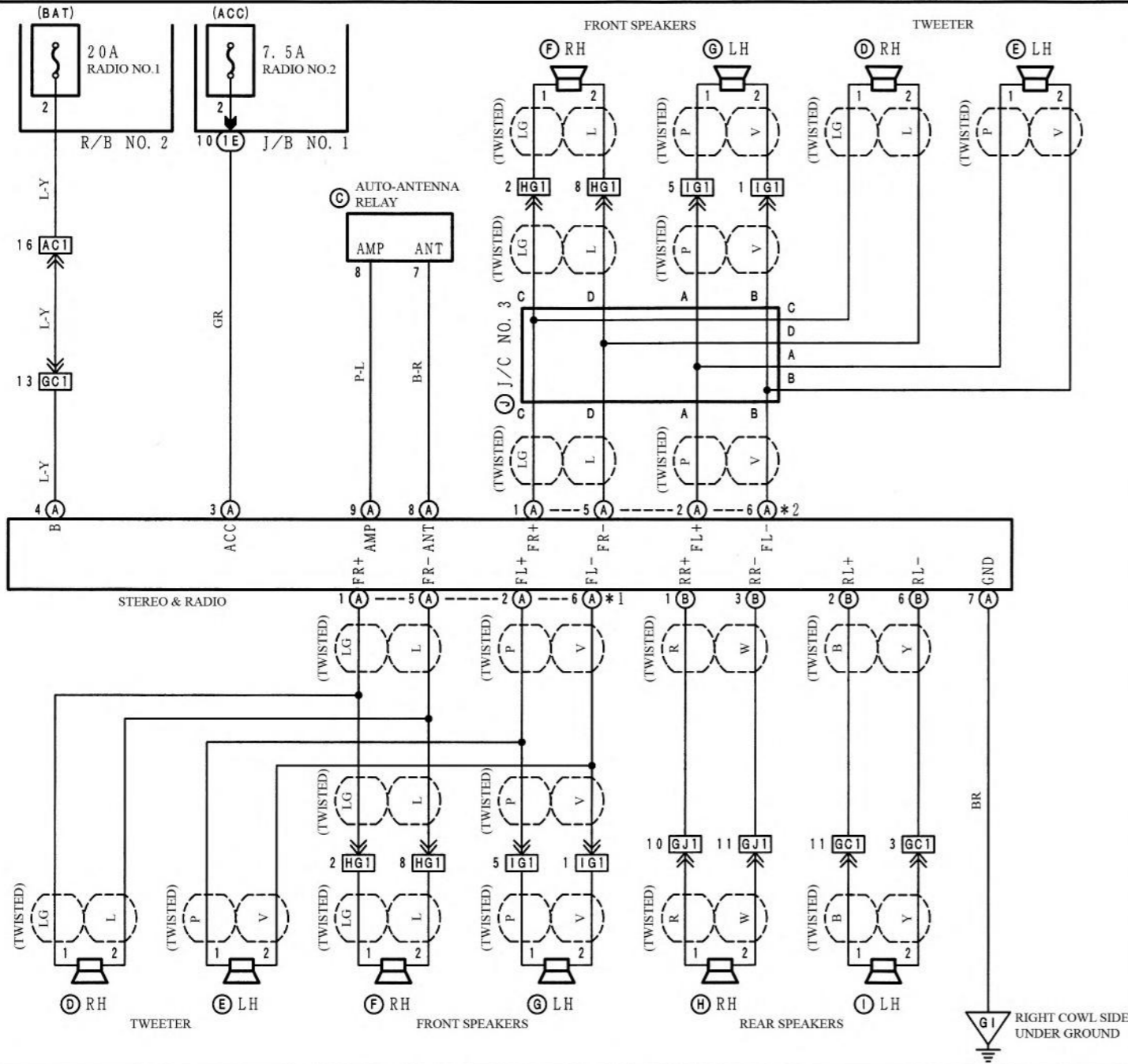

Shift lock (gated)

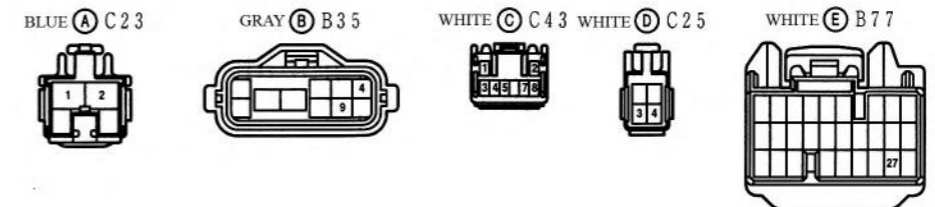
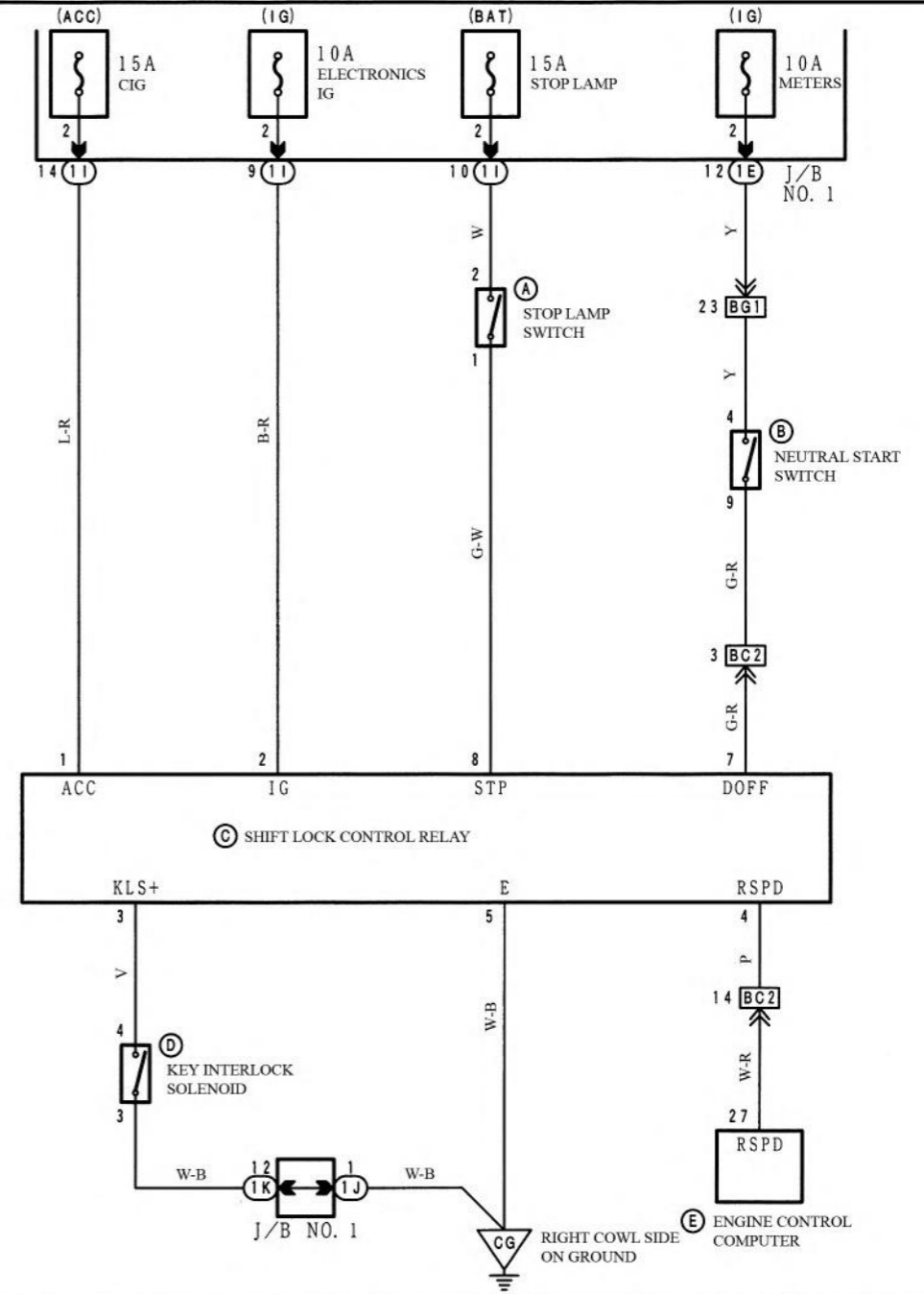

Audio (live sound system ~ '9 4, 8)

Cigarette lighter

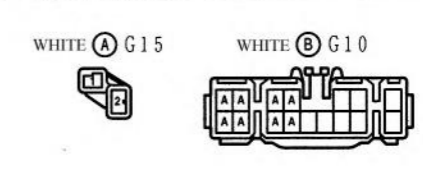
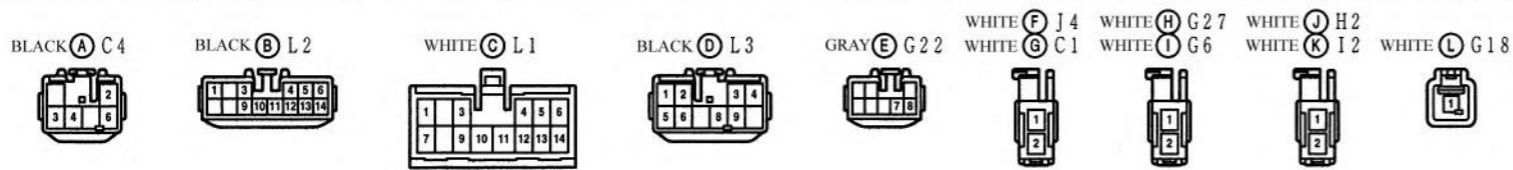
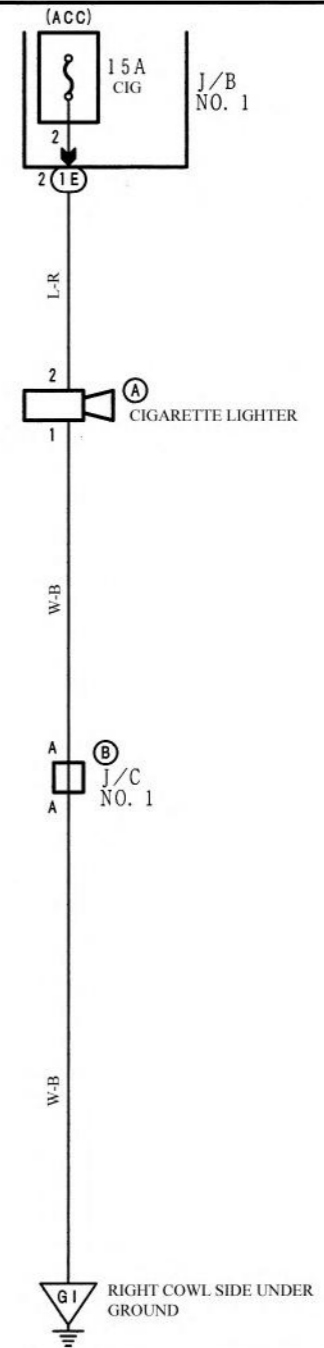
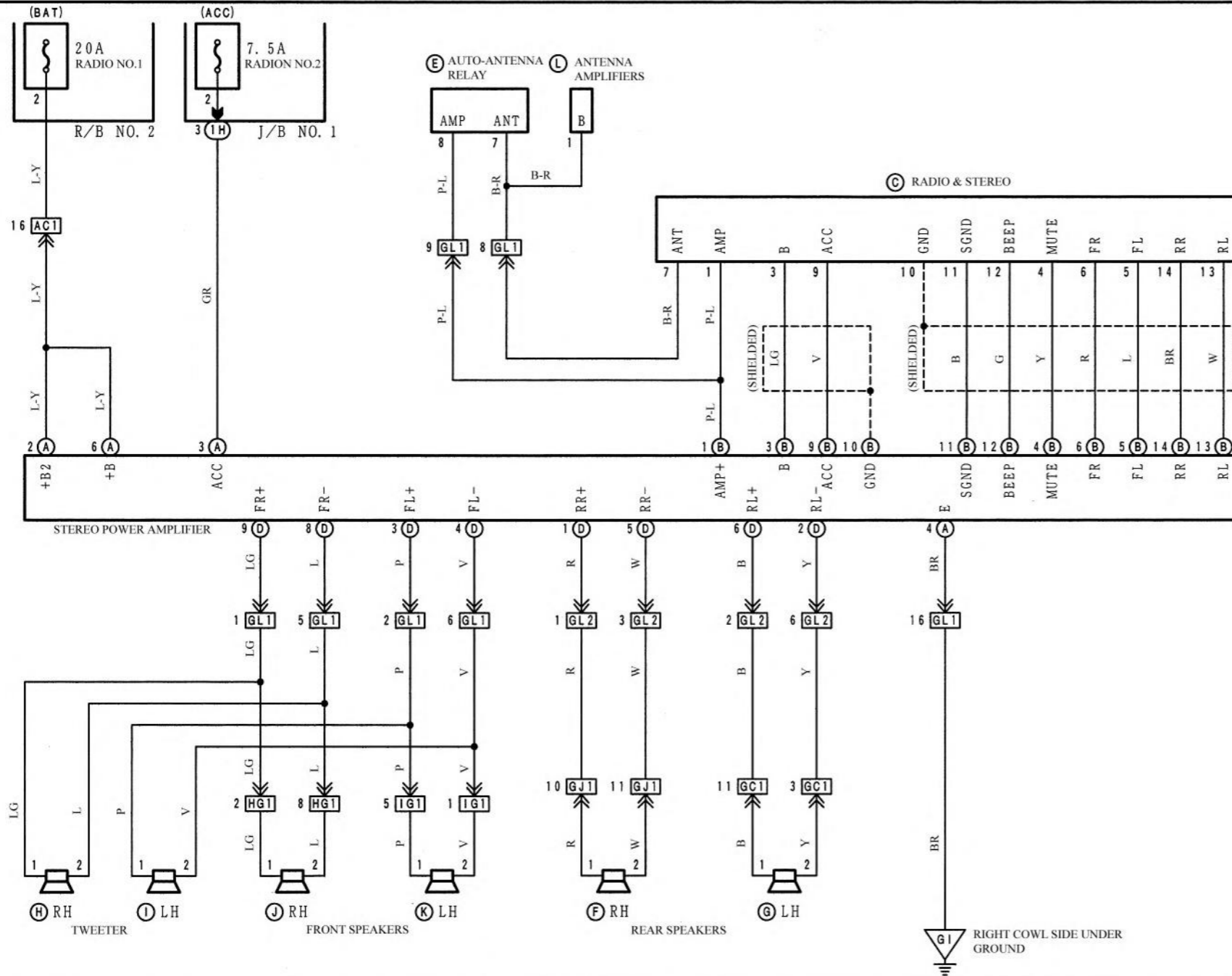

Head lamp

*1: 2JZ-GE~' 95.5 & 95.5~ *3:~' 96.4 *5:~' 97.8
 *2: 2JZ-GTE~' 95.5 *4:~' 96.4 *6:~' 97.8~

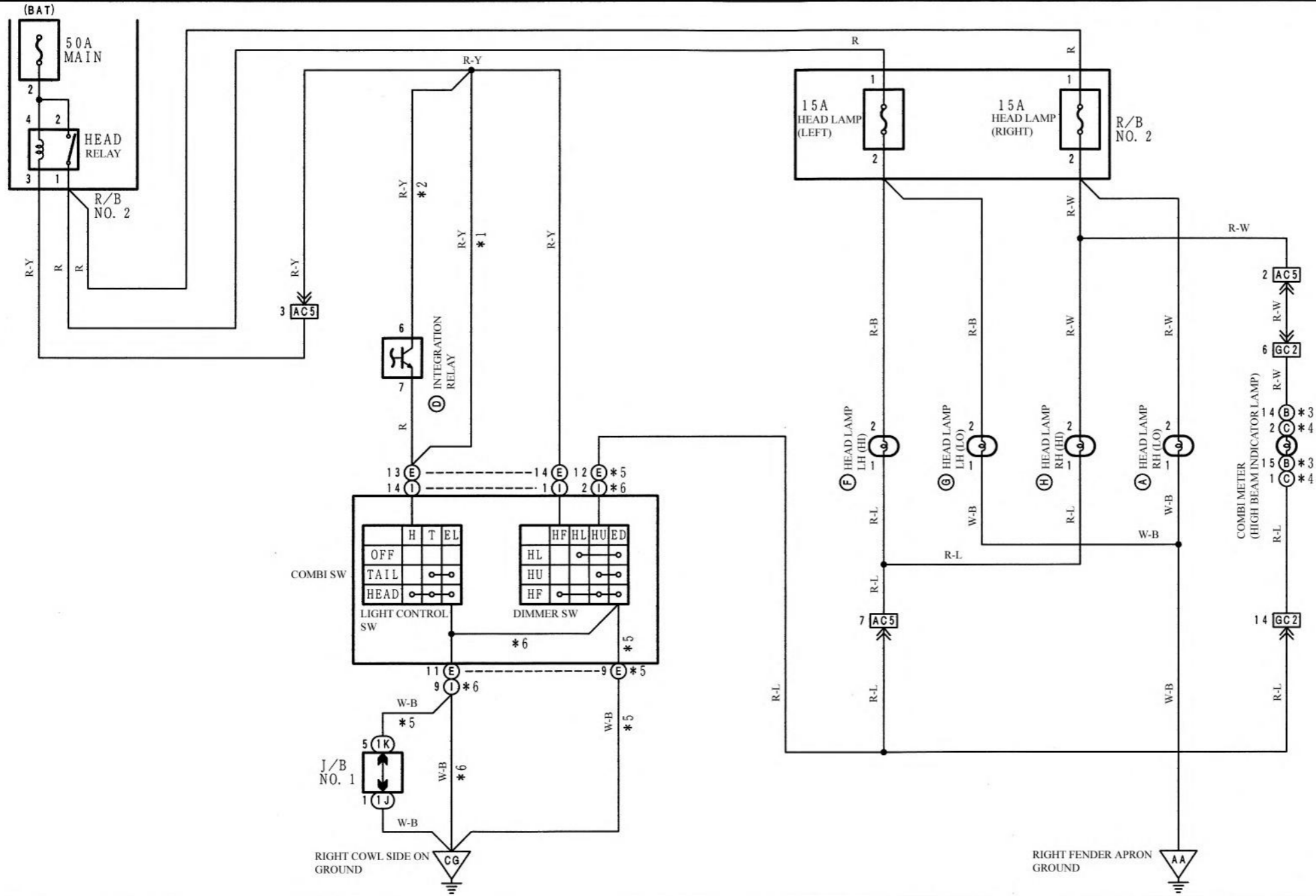

BROWN (A) A24 *3 BROWN (A) A24 *4
 BROWN (G) A8 *3 BROWN (G) A8 *4

WHITE (B) G25

BLUE (C) G23

WHITE (D) C19

BLACK (E) C21

BLACK (F) A11 *3 BLACK (F) A11 *4
 BLACK (H) A20 *3 BLACK (H) A20 *4

BLACK (I) C39

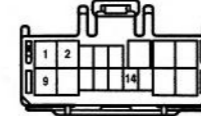
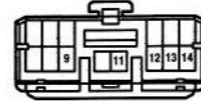
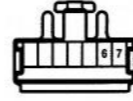
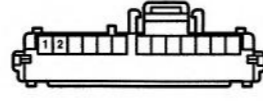
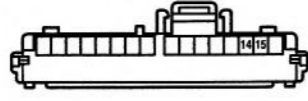

Turn signal & hazard

*1: 96.4 *3: 97.8
*2: 96.4 ~ *4: 97.8 ~

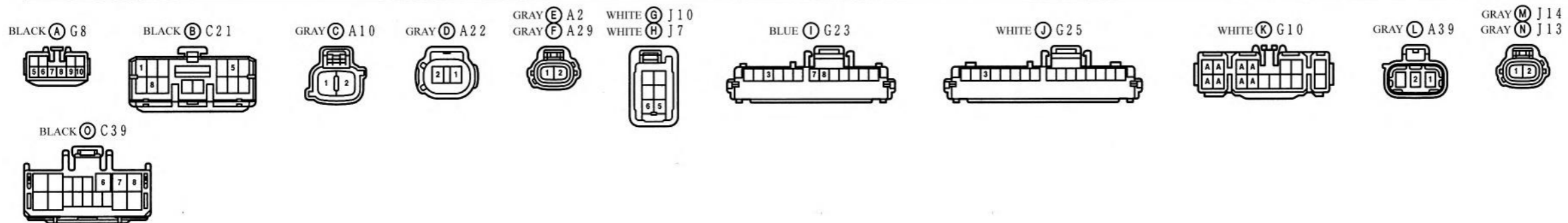
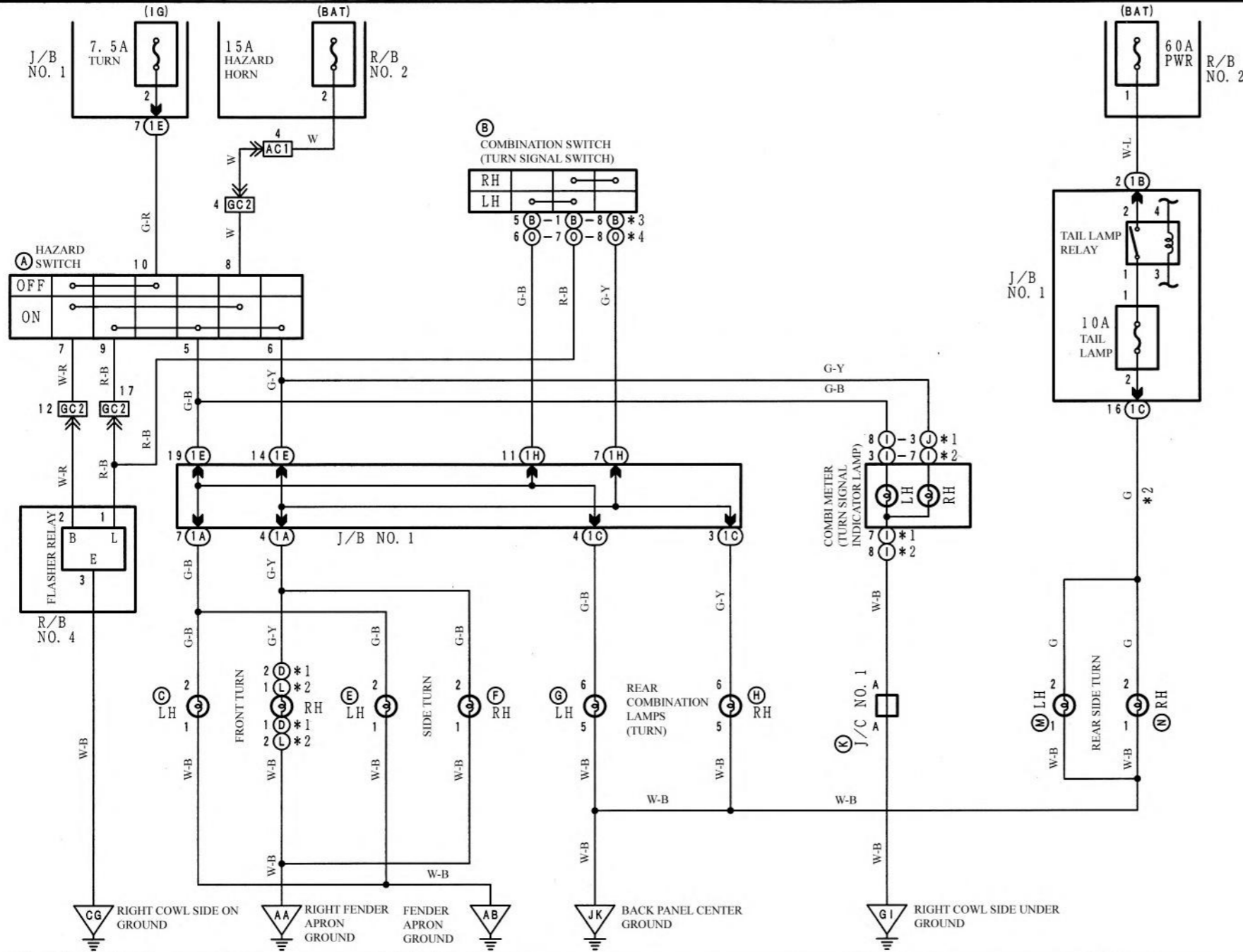

Lamp auto-cut & prevent forgetting to turn off lights

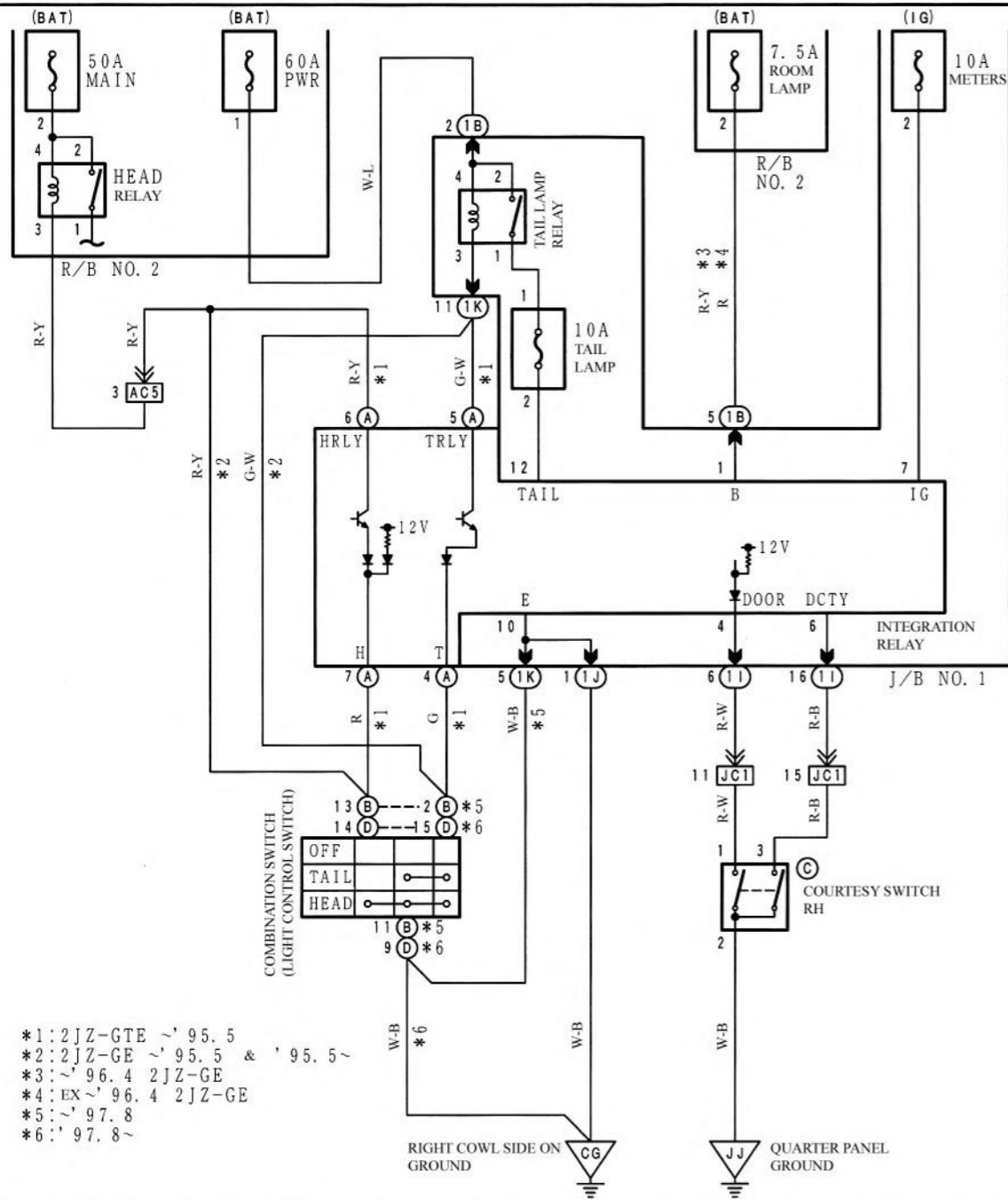

- *1: 2JZ-GTE ~ '95.5
- *2: 2JZ-GE ~ '95.5 & '95.5~
- *3: ~ '96.4 2JZ-GE
- *4: EX ~ '96.4 2JZ-GE
- *5: ~ '97.8
- *6: ~ '97.8~

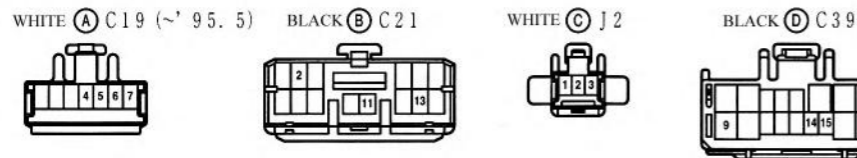

Fog lamp

- *1: ~ '96.4
- *2: ~ '96.4~
- *3: ~ '97.8
- *4: ~ '97.8~

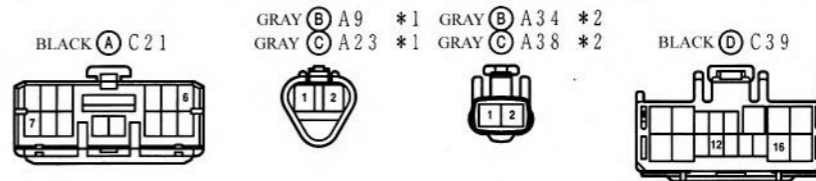
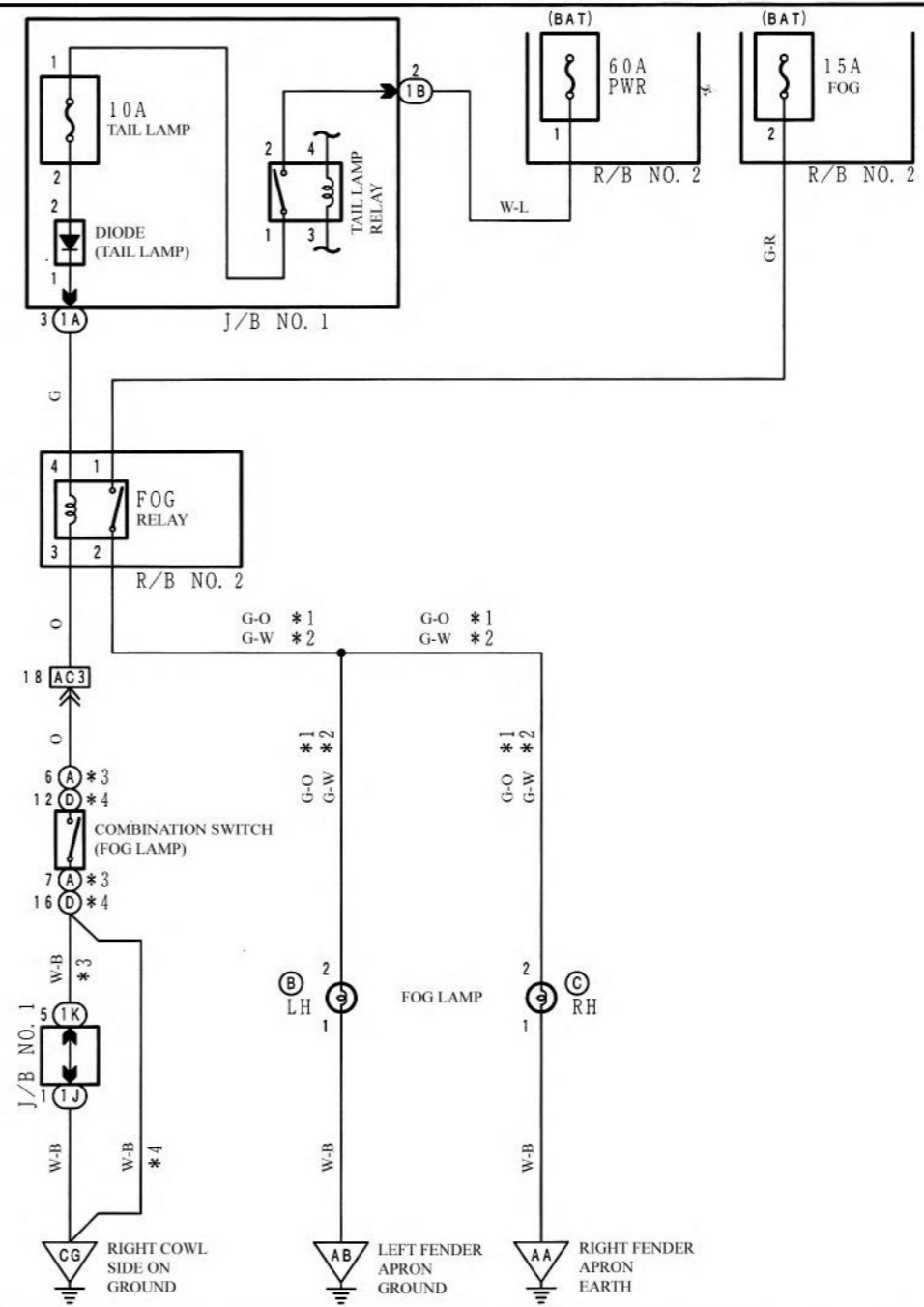

Stop lamp

*1: '96.4
*2: '96.4~

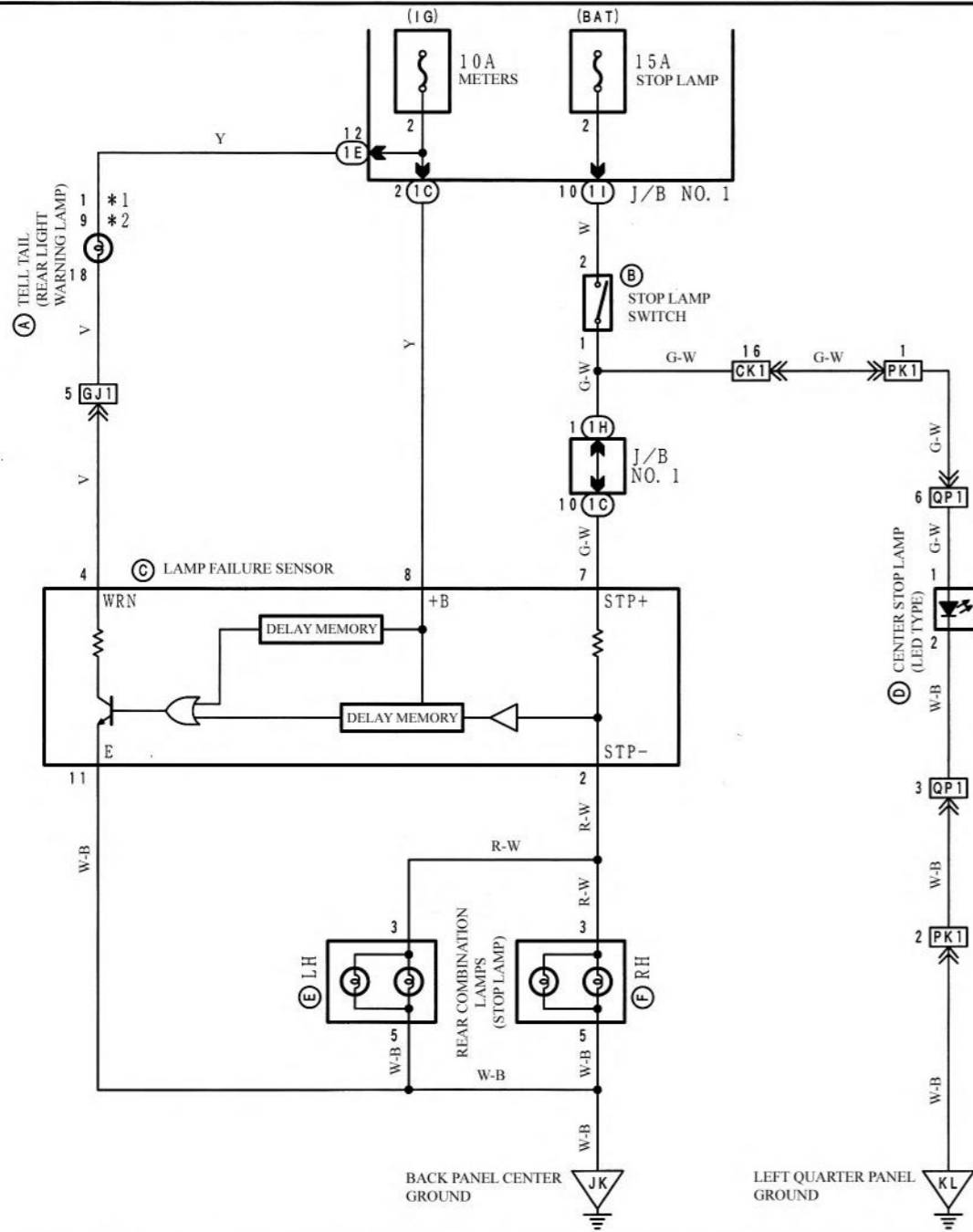

Shift indicator ('97.8 ~ @ 2JZ-GTE)

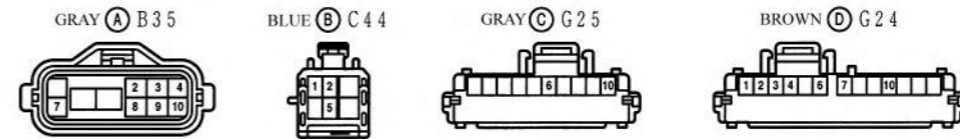
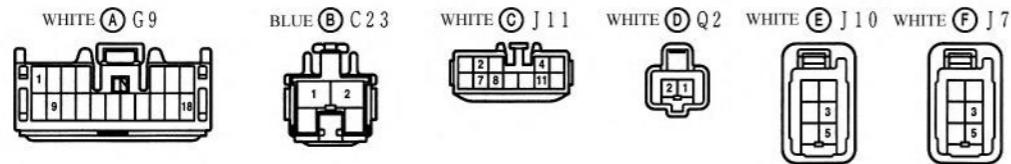
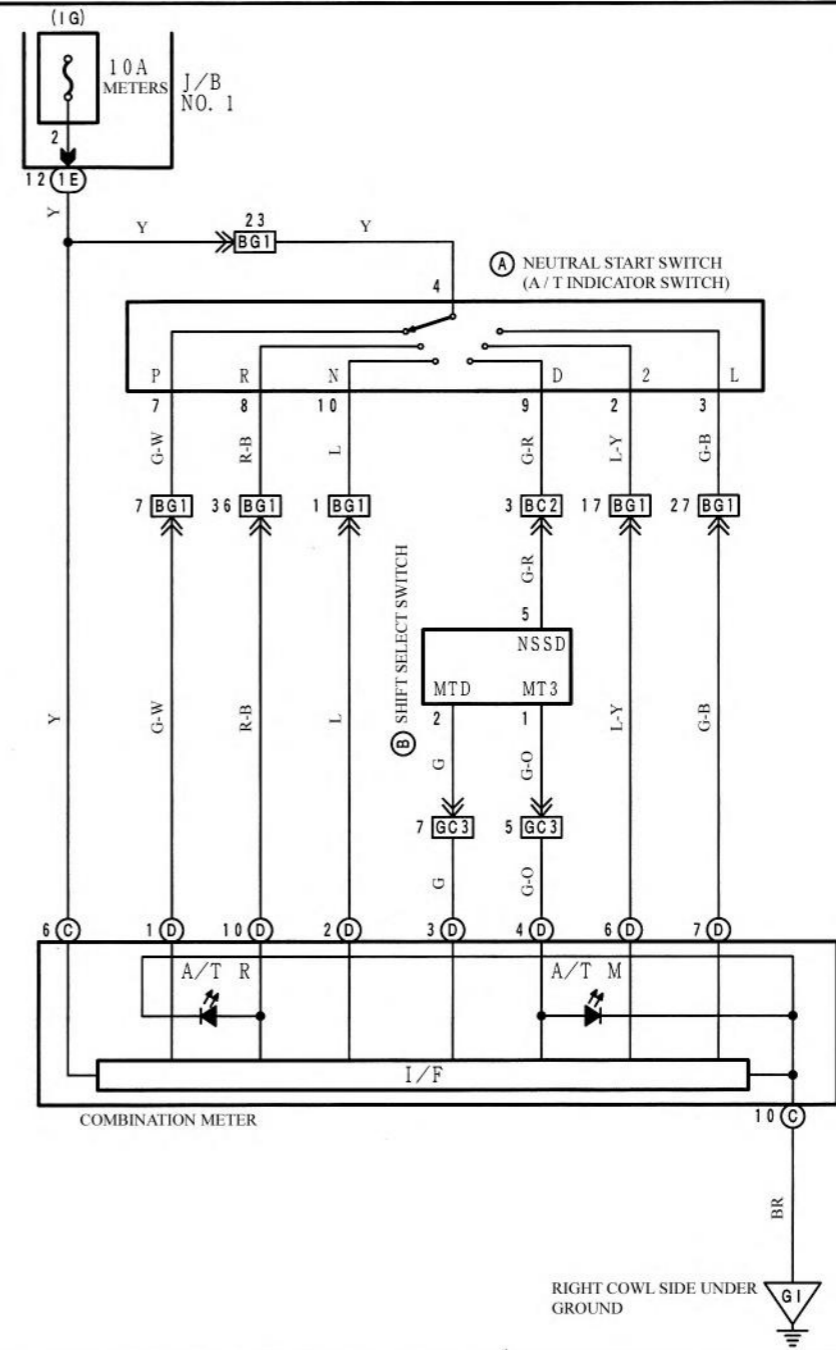

Tail lamp

*1: 2JZ-GTE ~ '95.5
 *2: 2JZ-GE ~ '95.5 & '95.5~
 *3: ~ '96.4
 *4: '96.4~
 *5: ~ '97.8
 *6: '97.8~

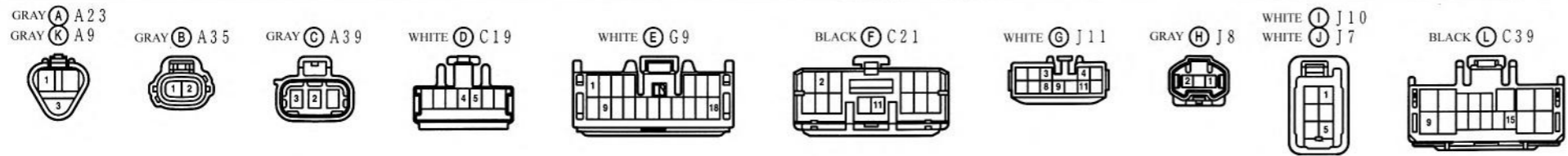
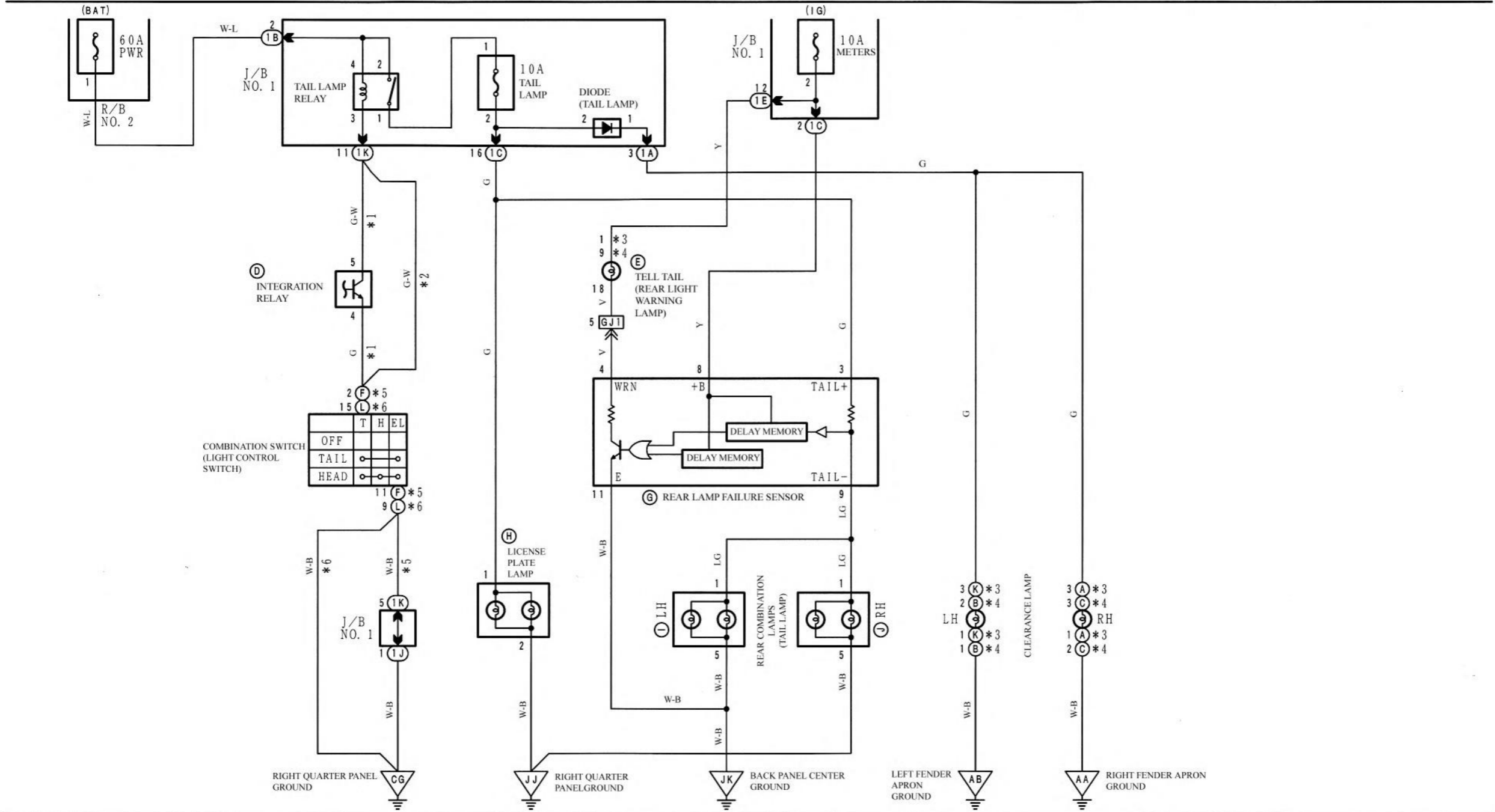

Interior lamp

*1:~'96.4 2JZ-GE *3:~'94.8 *5:~'95.5 2JZ-GTE *7:~'96.4 2JZ-GTE *9:'96.4~
 *2:EX~'96.4 2JZ-GE *4:'94.8~ *6:~'96.4 *8:EX~'96.4 2JZ-GTE

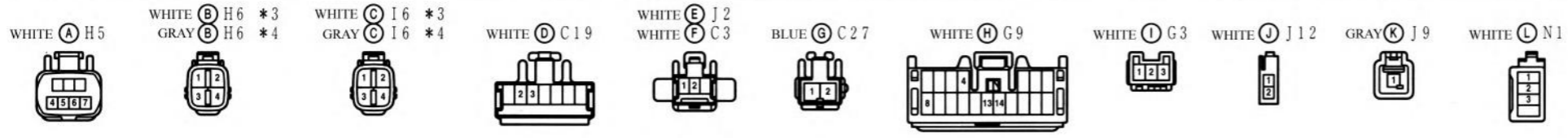
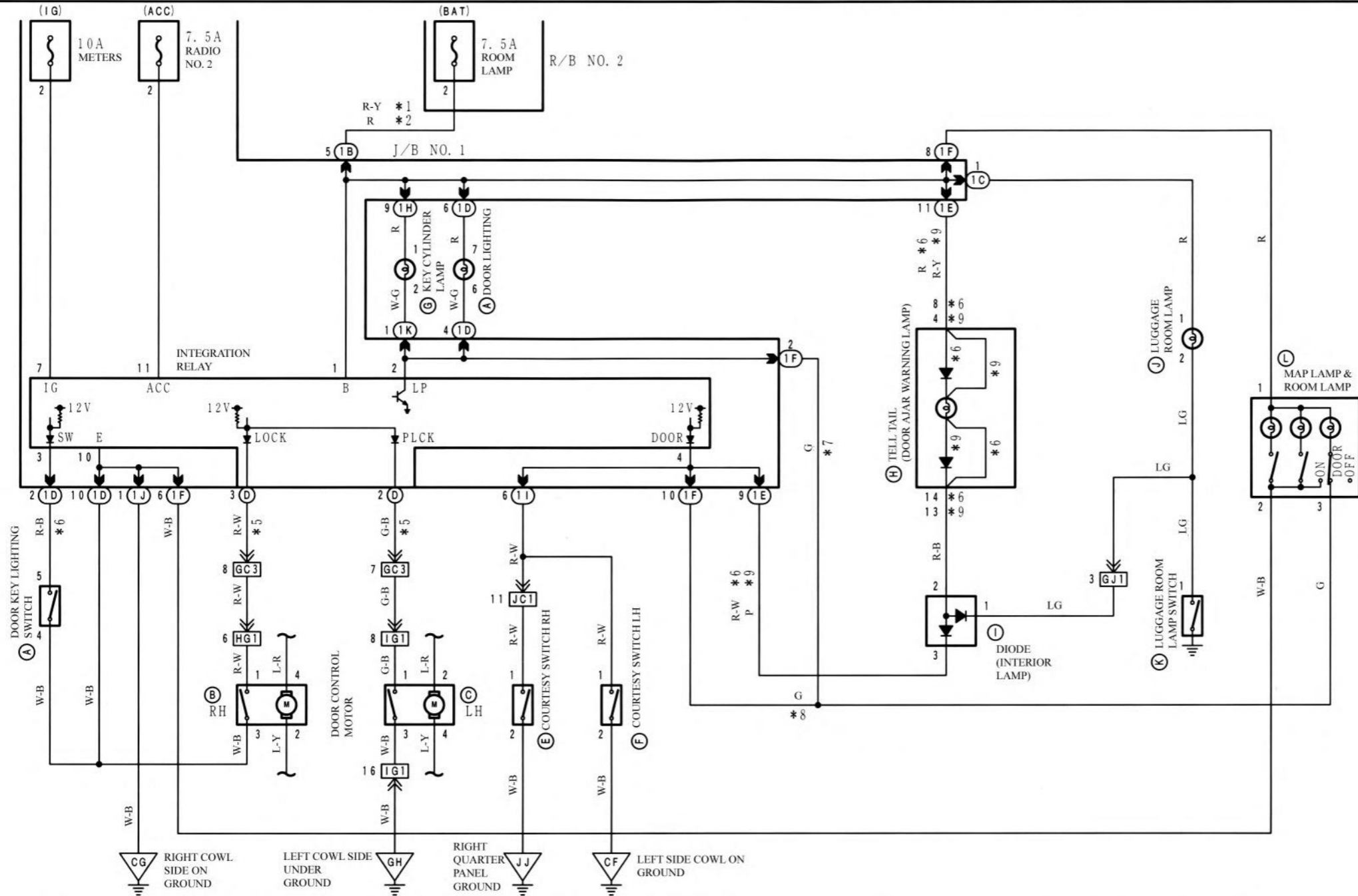

Illumination

*1: 2JZ-GE ~'95.5, '95.5~ *4: '94.8~ *7: '96.4~ *10: LIVE SOUND SYSTEM *13: '97.8~の2JZ-GTE
 *2: 2JZ-GTE ~'95.5 *5: 2JZ-GTE *8: ~'97.8 *11: SUPER LIVE SOUND SYSTEM
 *3: ~'94.8 *6: ~'96.4 *9: '97.8~ *12: '97.8~の2JZ-GE

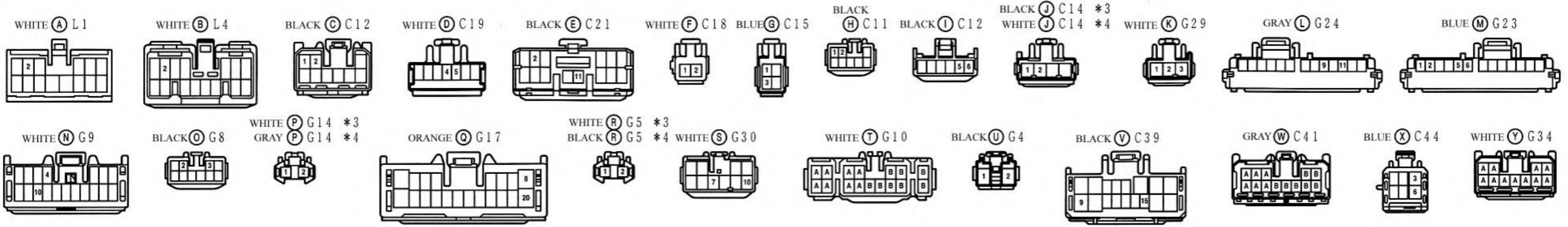
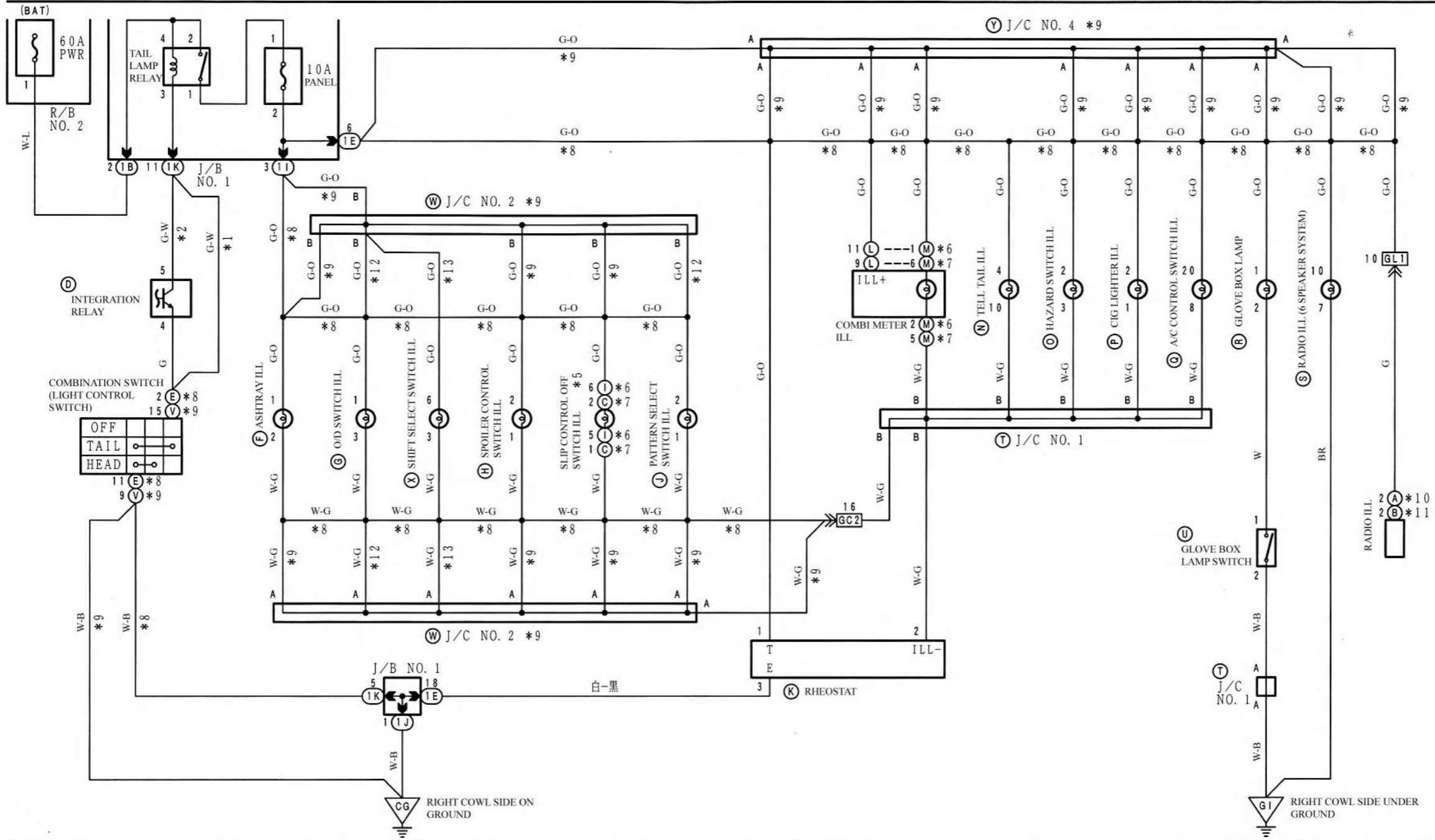

Auto air conditioner

*1: 2JZ-GE *3: ~' 94.8 *5: ~' 95.5 *7: ~' 96.4 *9: ' 96.4~ 2JZ-GTE
 *2: 2JZ-GTE *4: ' 94.8~ *6: ' 95.5~ *8: ' 96.4~

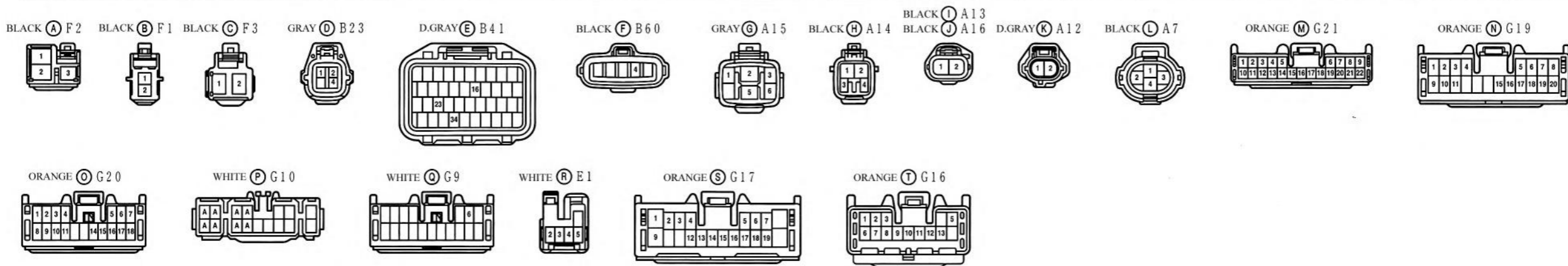
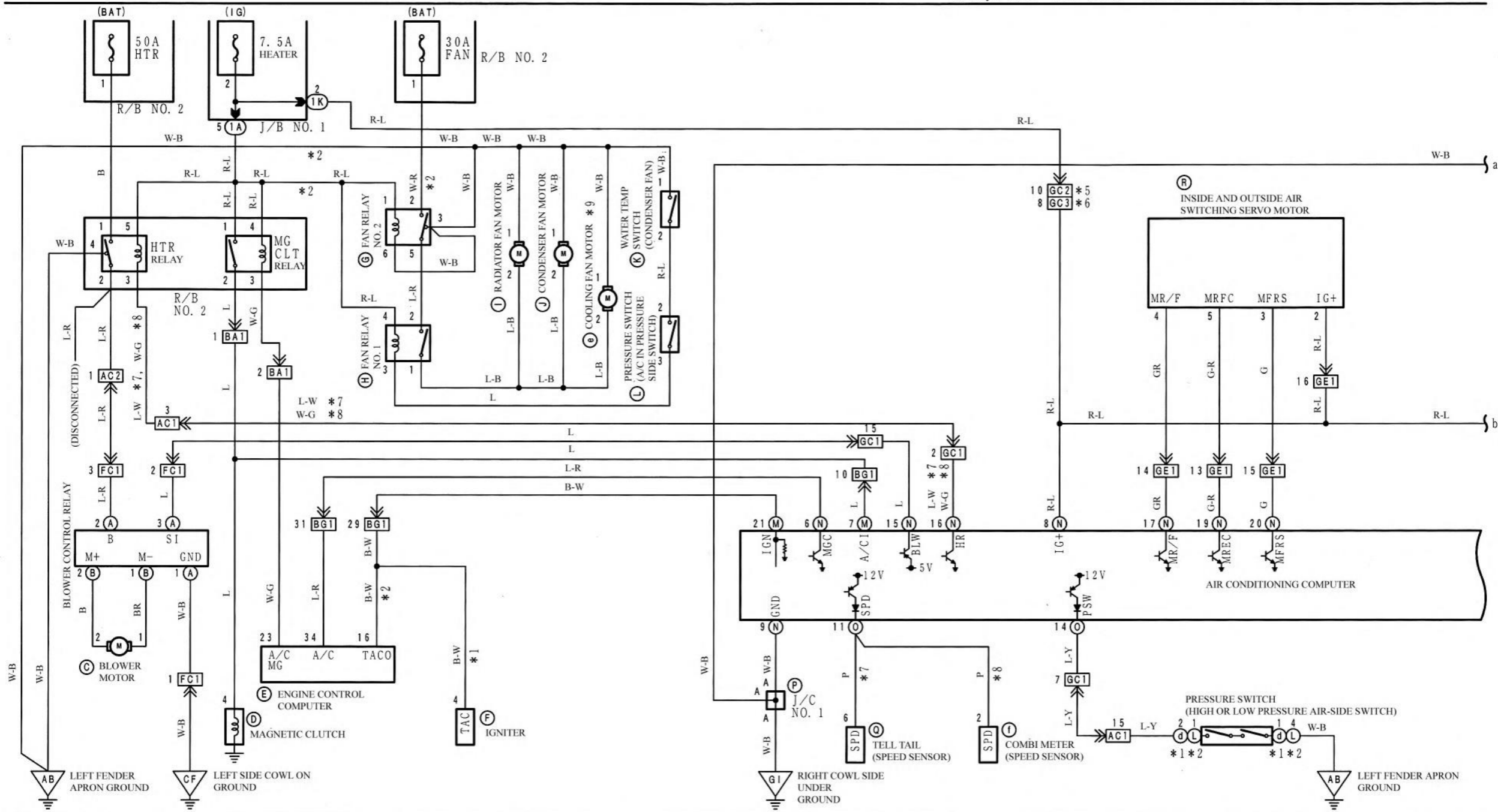

Auto air conditioner

*7: 96.4
*8: 96.4

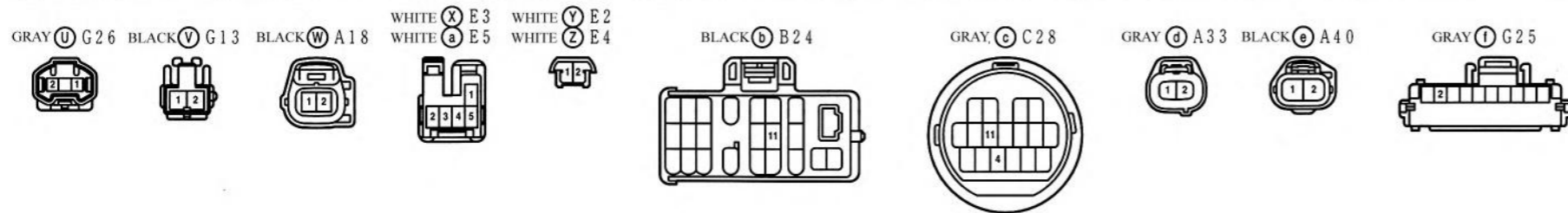
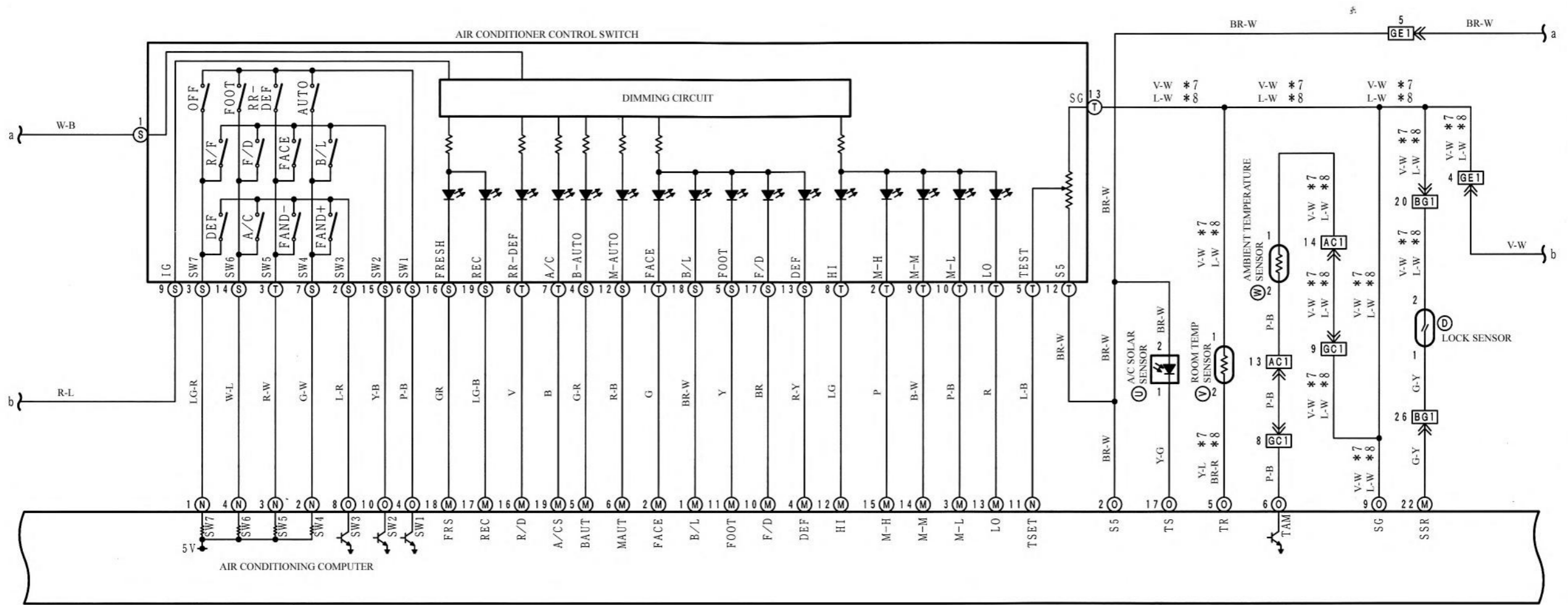

Auto air conditioner

*3: '94.8 *6: '95.5~ *8: '96.4~
 *5: '95.5 *7: '96.4

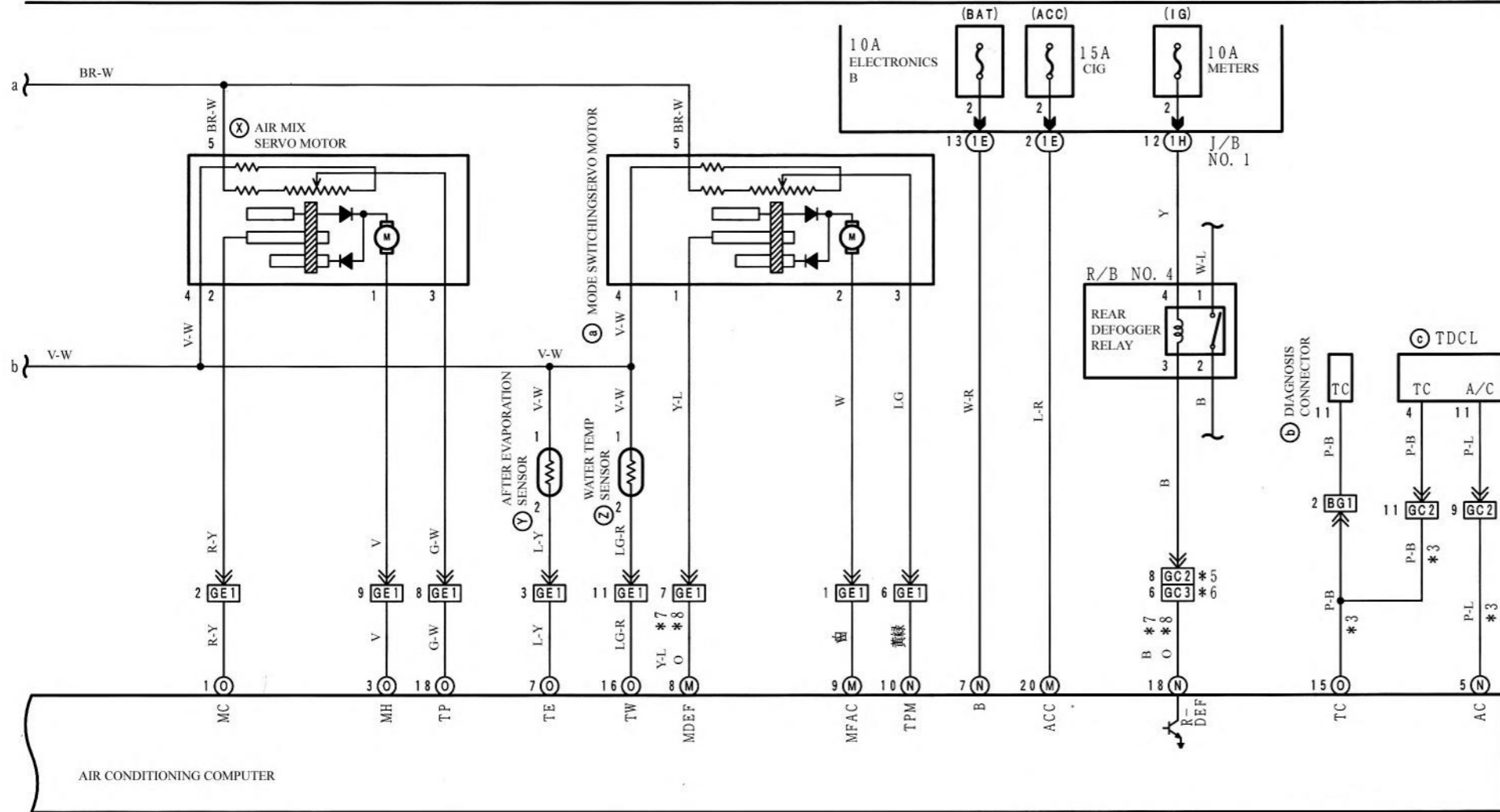

Clock

*1: ~ 96.4 2JZ-GE
 *2: EX ~ 96.4 2JZ-GE
 *3: ~ 97.8
 *4: ~ 97.8

Backup lamp

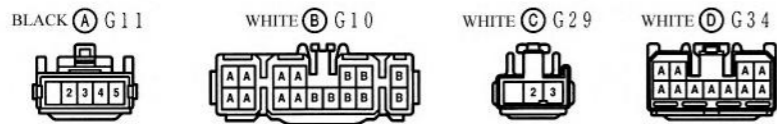
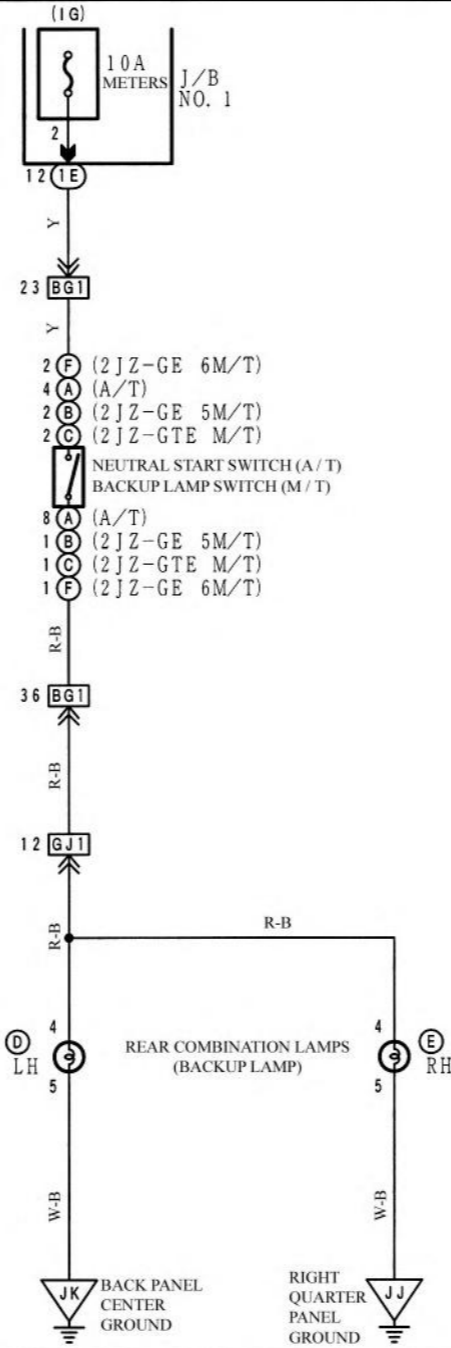
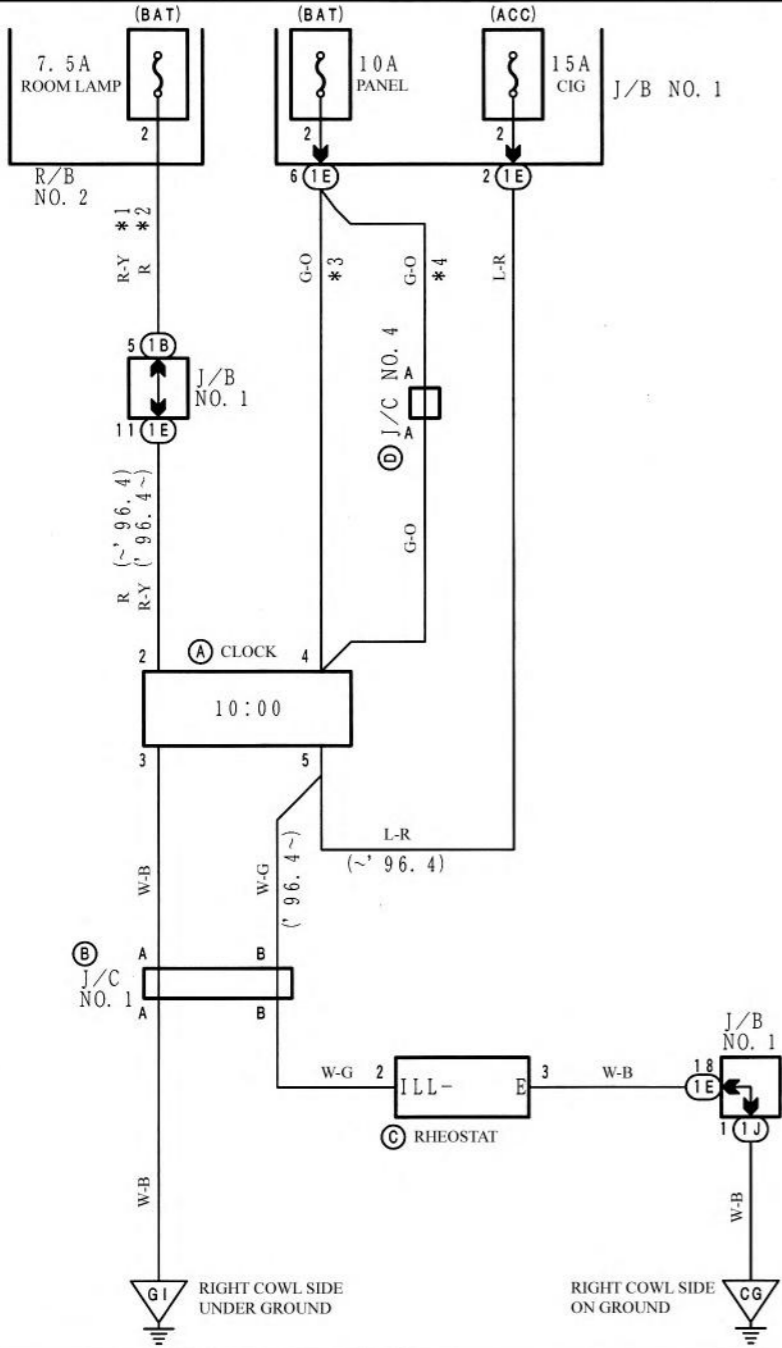

Fuse over load

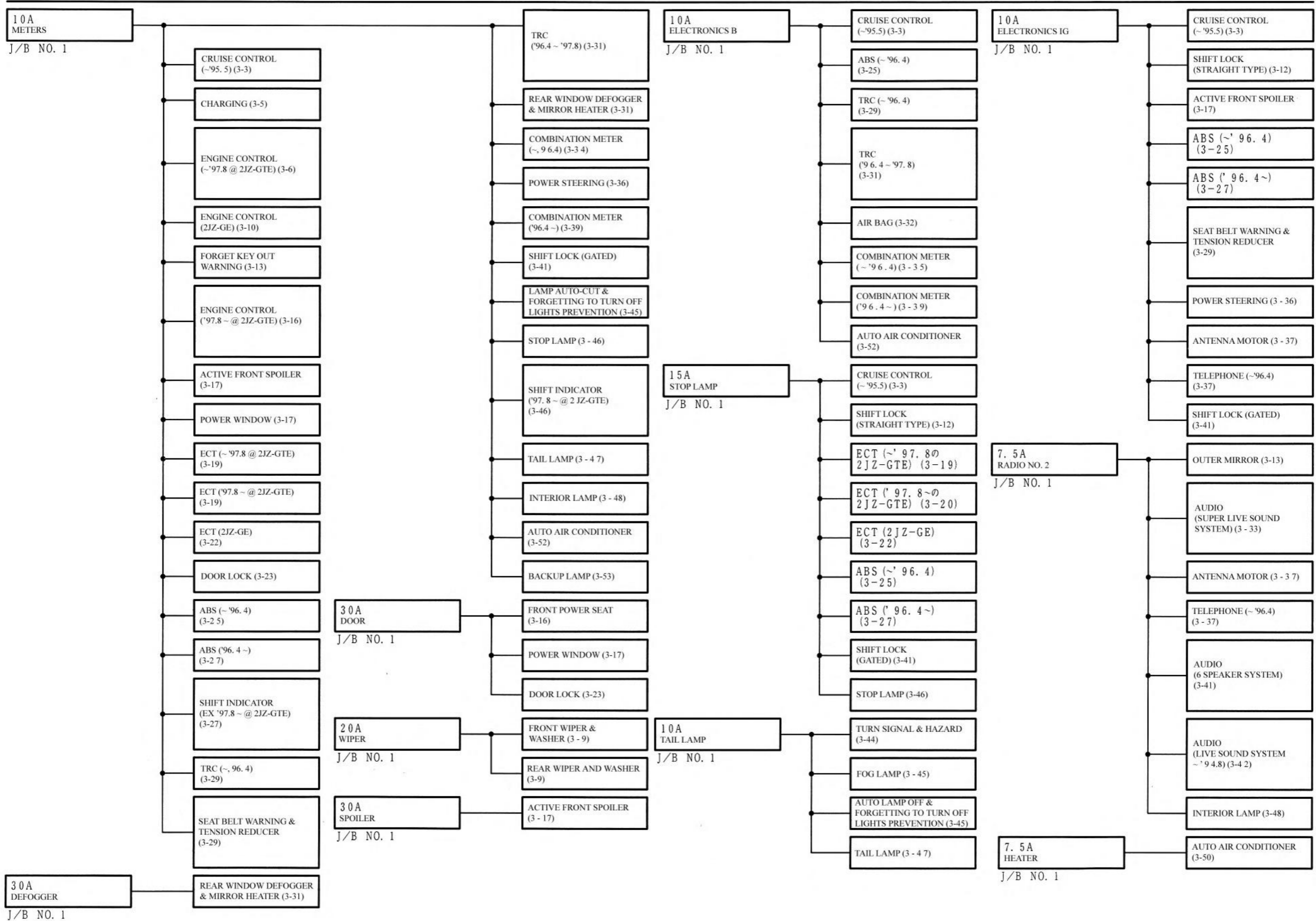

Fuse over load

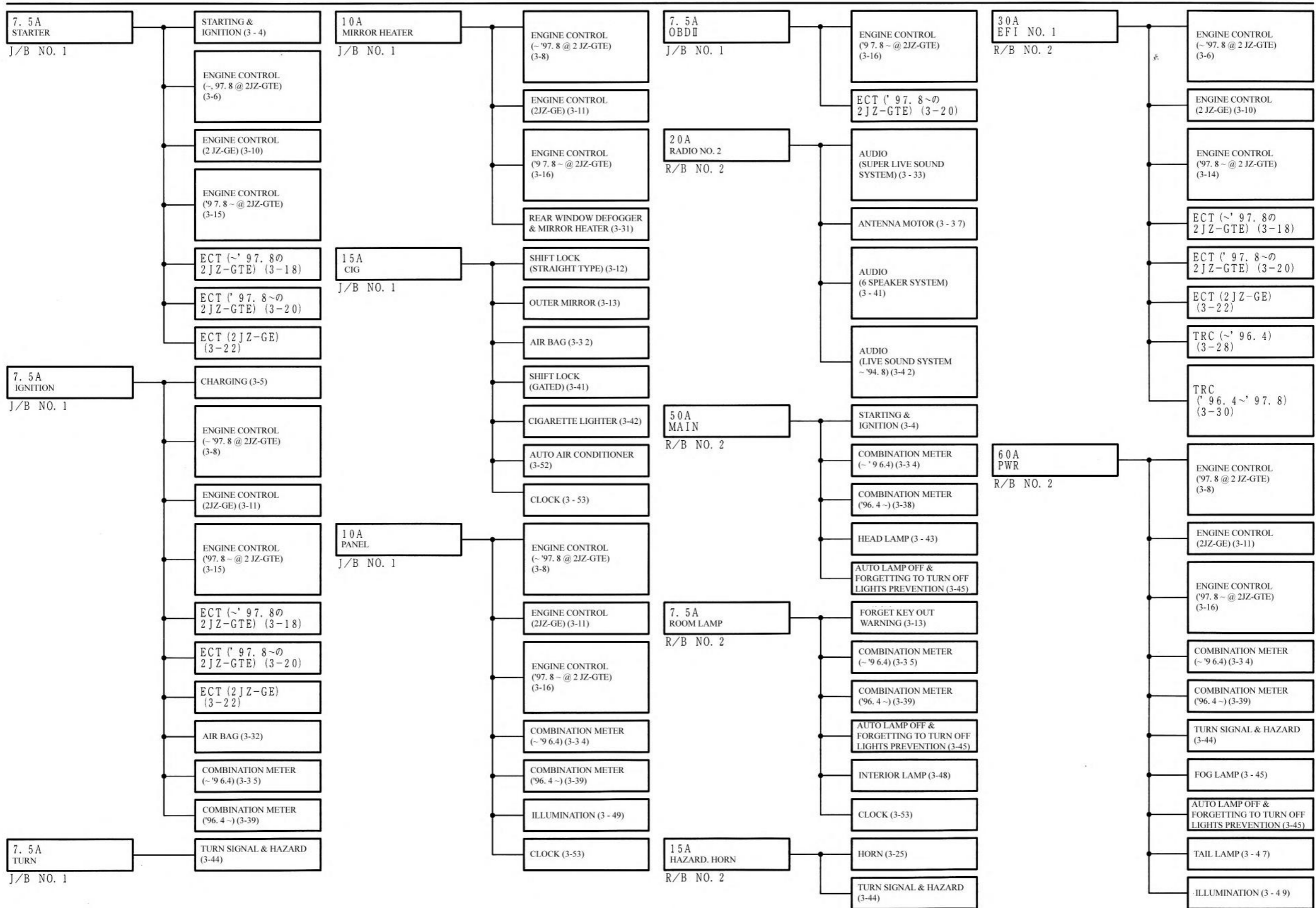

Fuse over load

*1: ~' 97. 8 2JZ-GTE
*2: ' 97. 8 ~ 2JZ-GTE

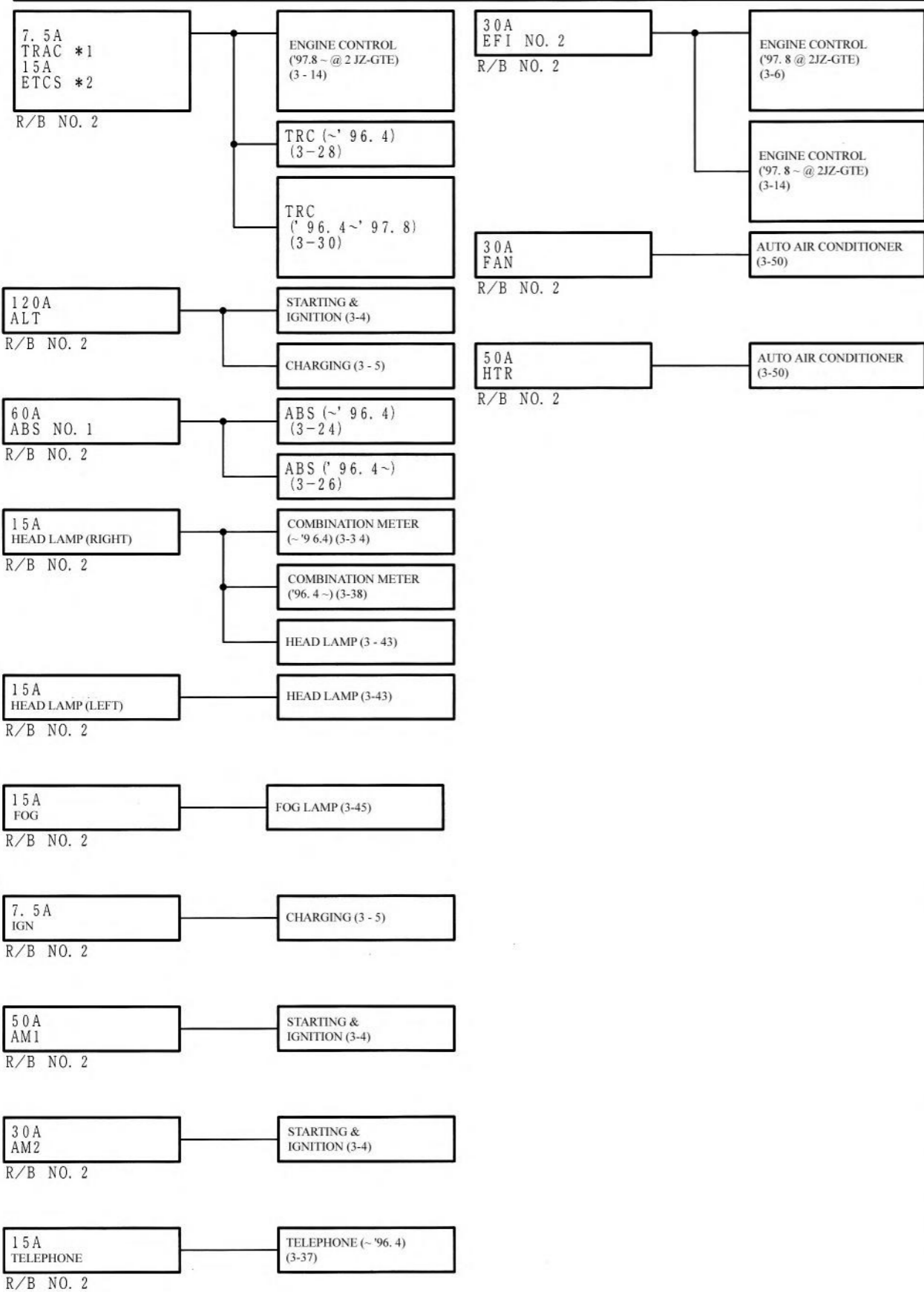

Ground over load

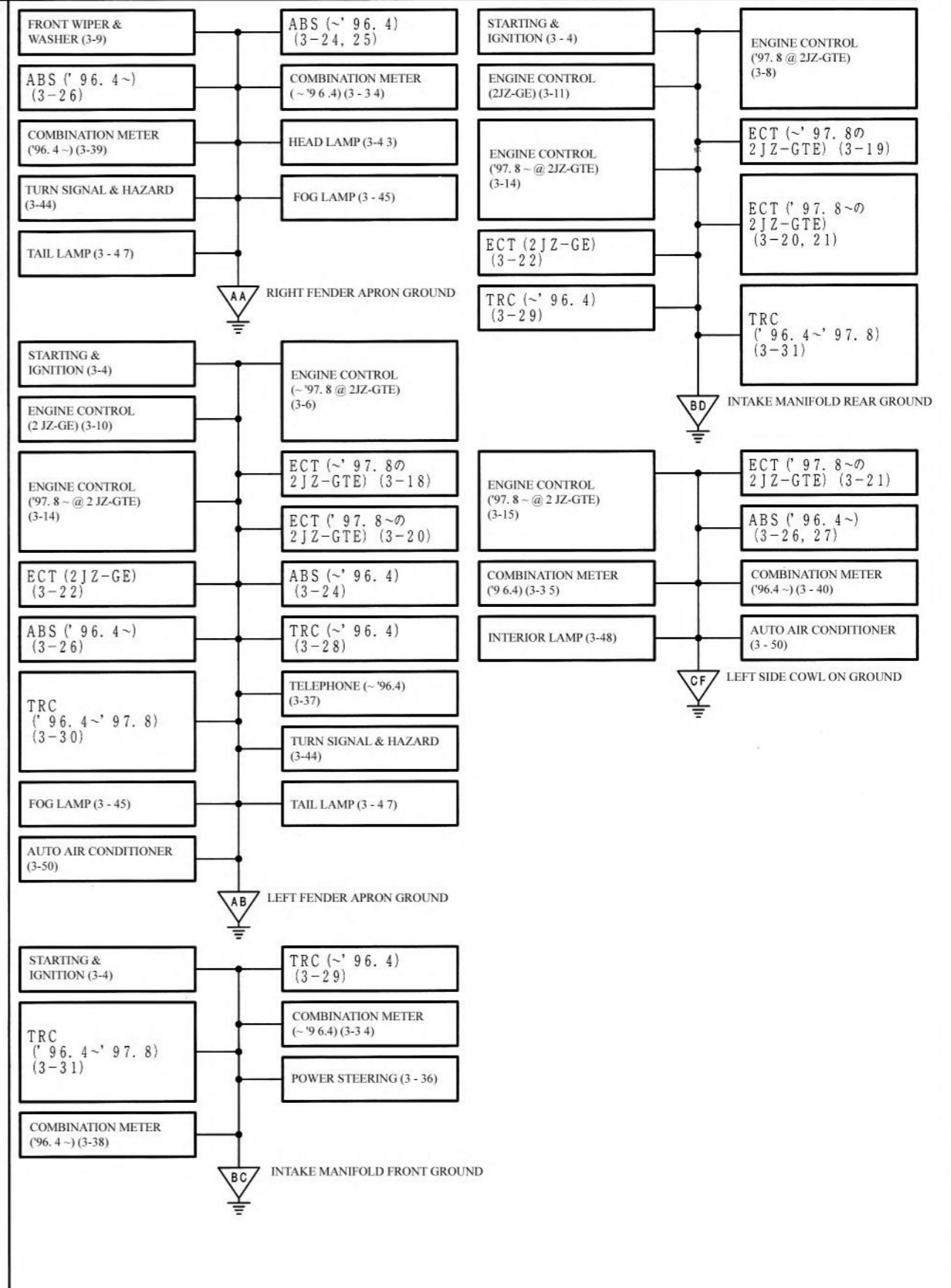

Ground over load

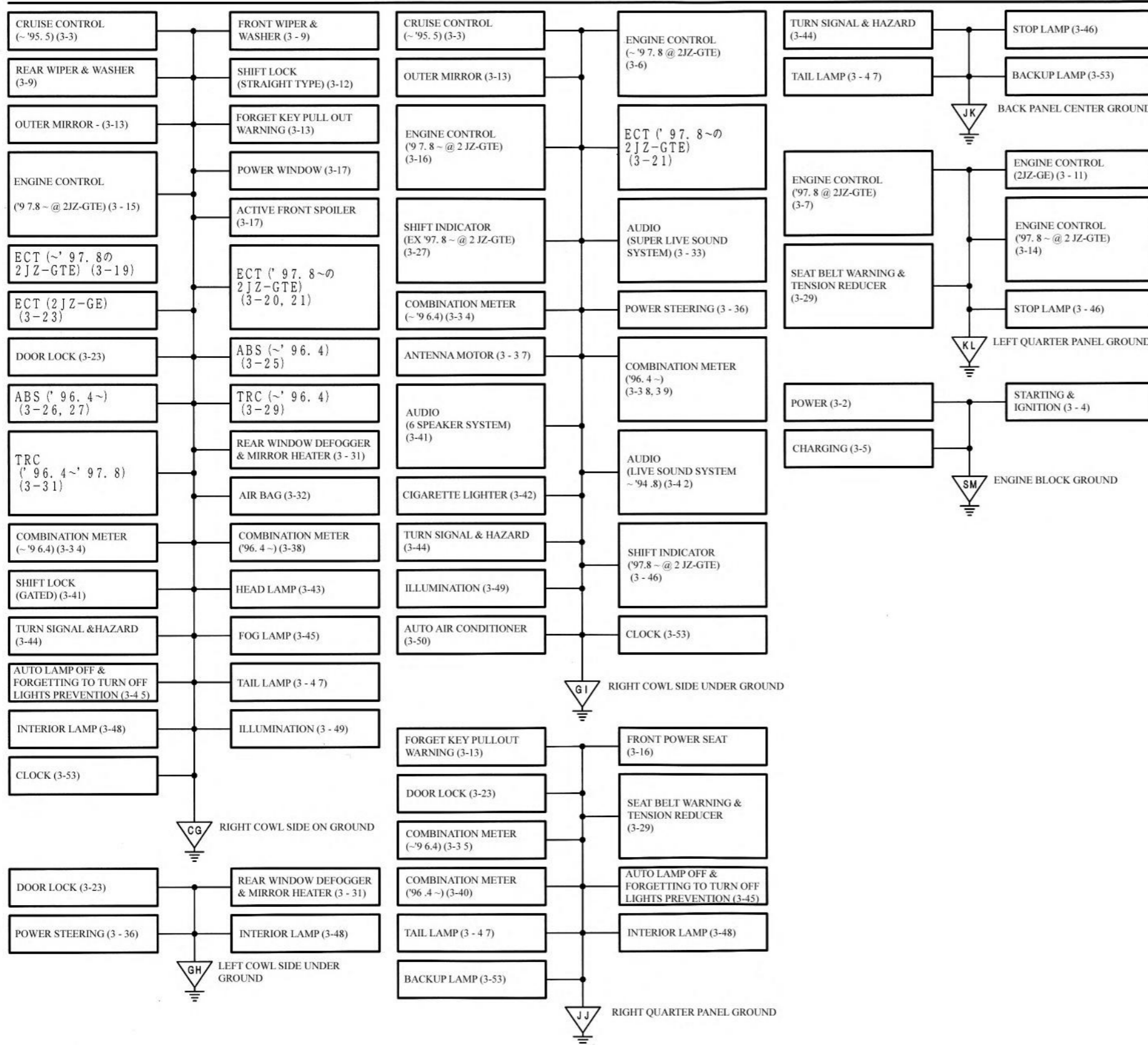

4 Common connector

J/B, R/B

J/B No.1 & R/B No.4 4-2

R/B No.2 4-5

R/B No.5 4-6

Wire to Wire

Wire to Wire 4-7

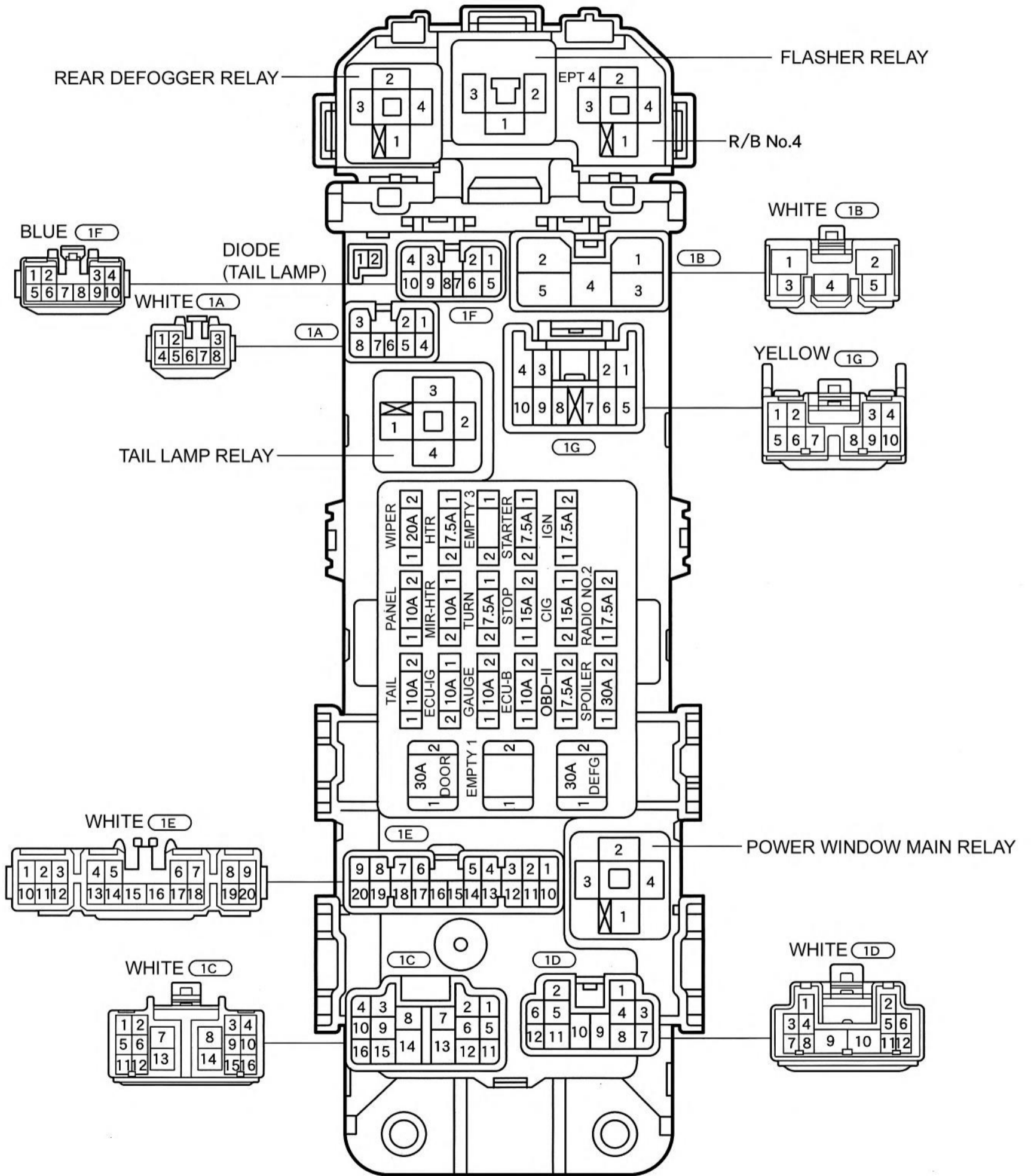

J/B No.1 & R/B No.4 (RIGHT SIDE COWL)

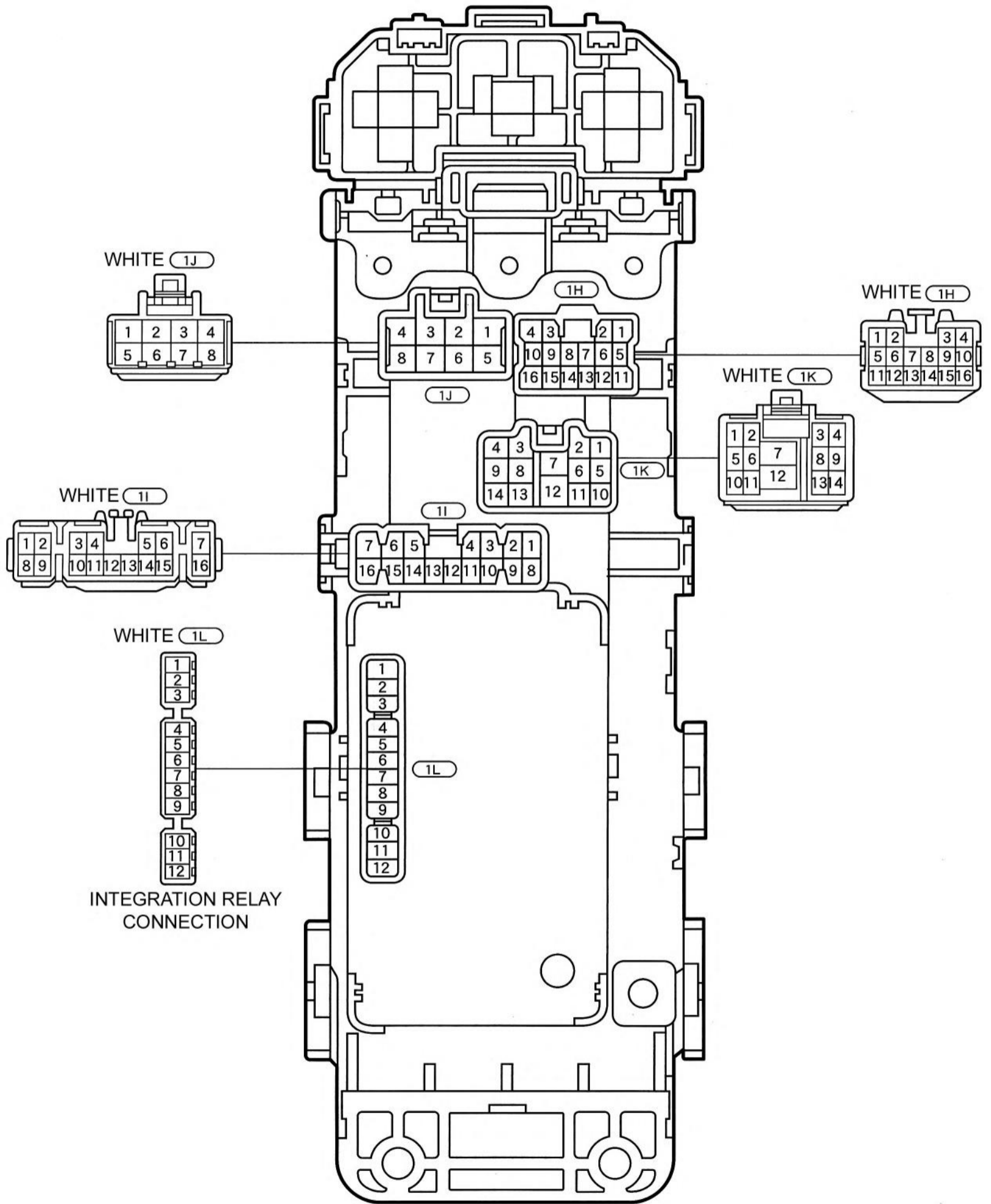

J/B No.1

J/B No.1 INTERNAL CIRCUIT

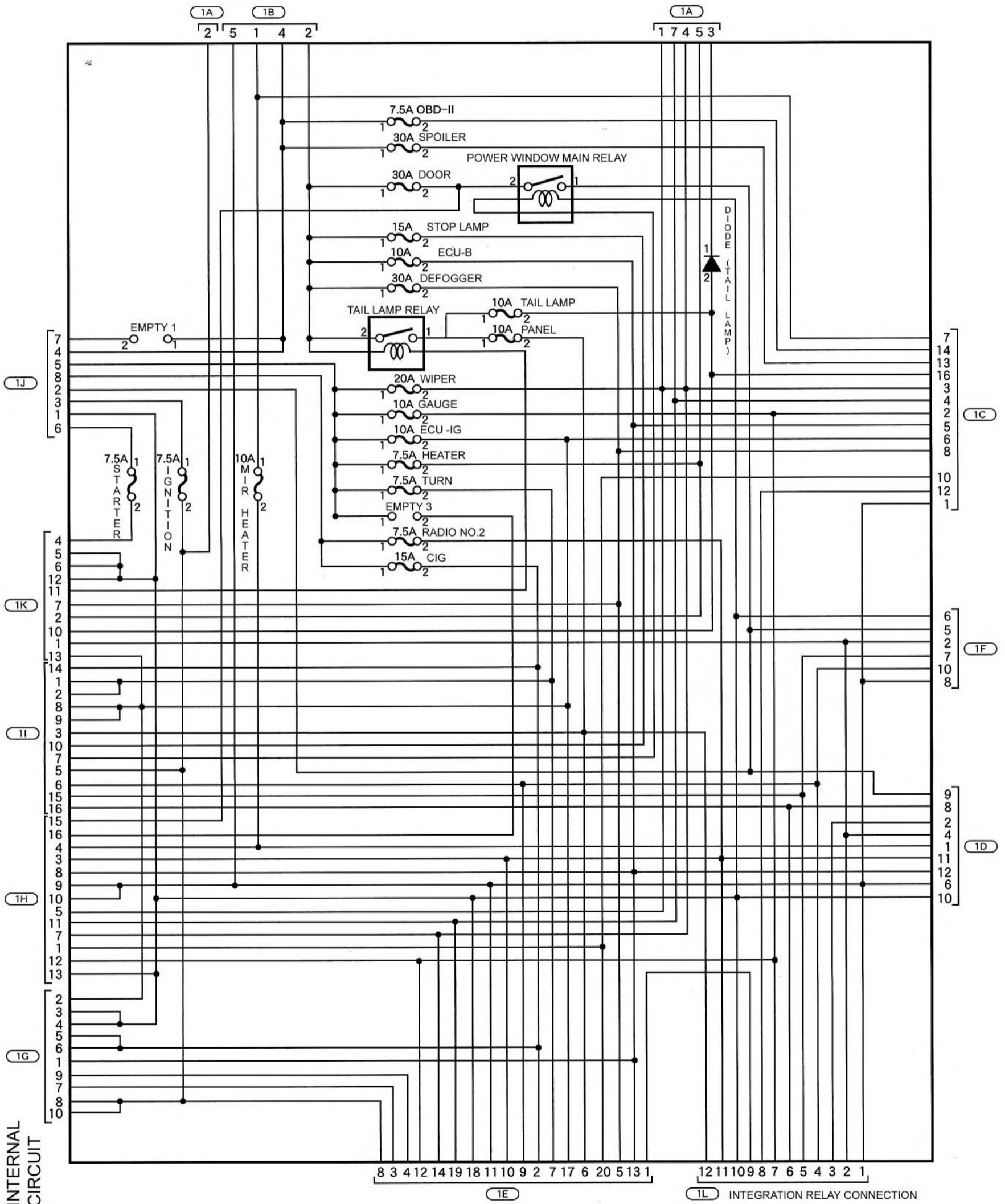

R/B No.2

R/B No.2 (ENGINE ROOM LEFT)

R/B No.2 INTERNAL CIRCUIT

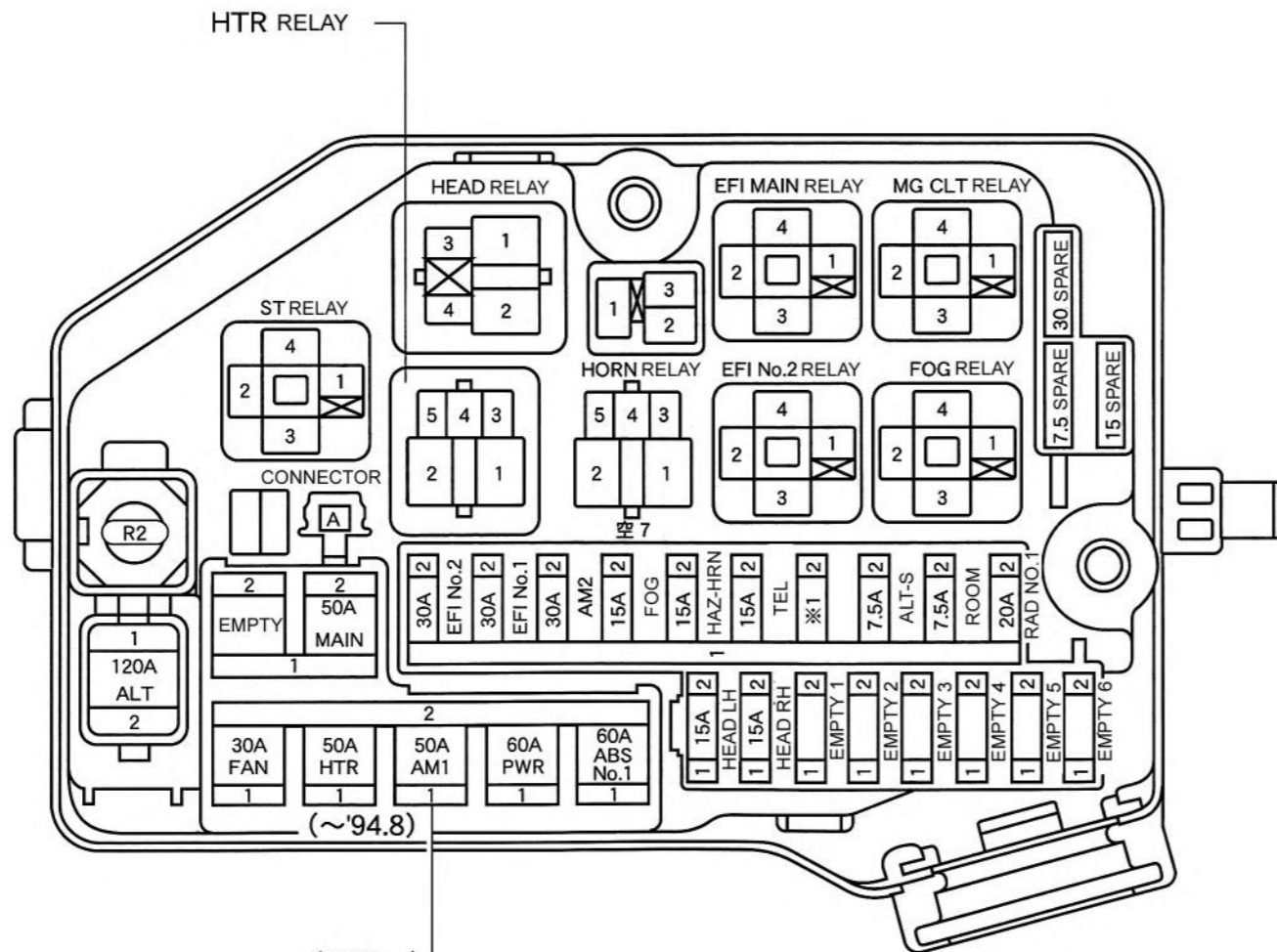

(~'94.8)

50A HTR	30A FAN	60A ABS No.1	50A AM1	60A PWR
1	1	1	1	1

7.5A TRAC (~'97.8 2JZ-GTE)
 ※1 15A ETCS ('97.8~ 2JZ-GTE)

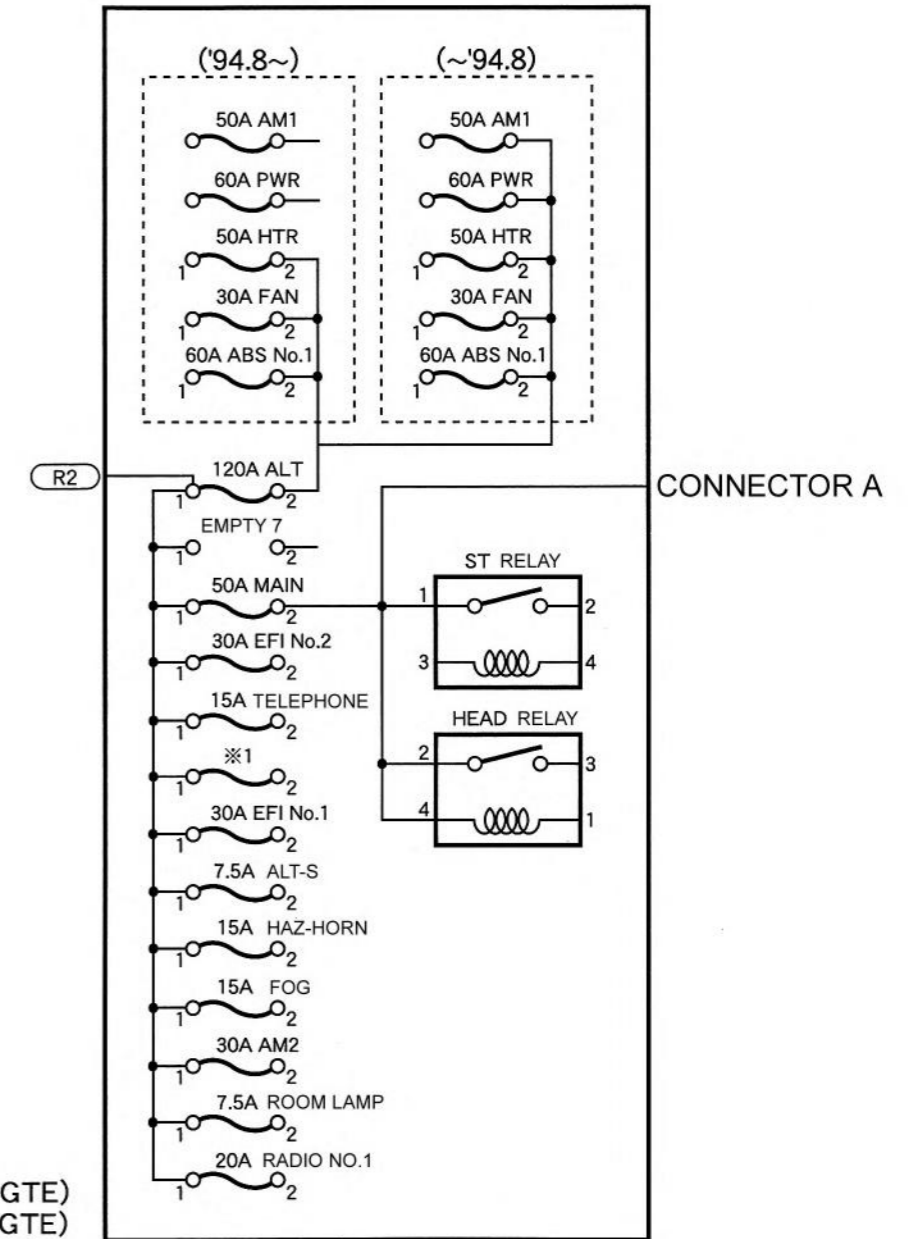

R/B No.5 (ENGINE ROOM RIGHT)

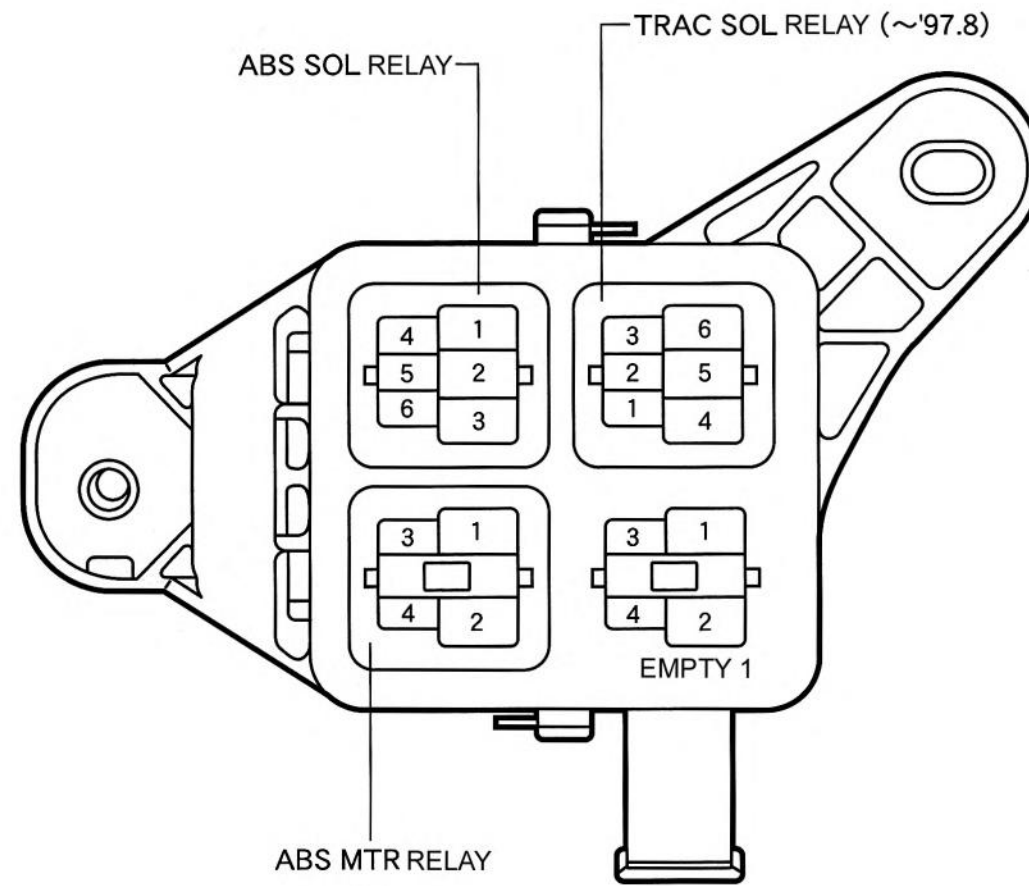

Wire to Wire

*1: ~'97.8
*2: '97.8~

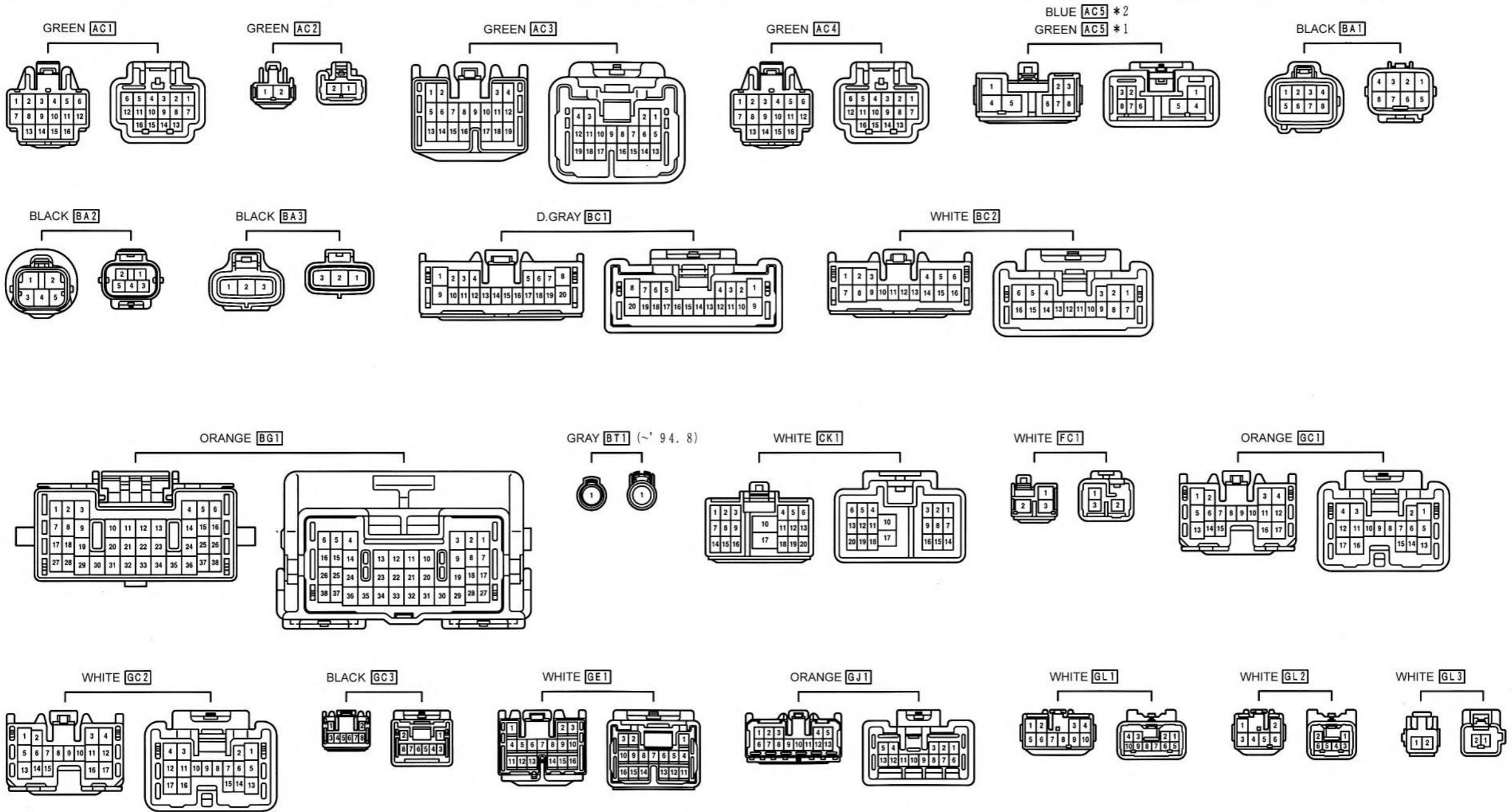

Wire to Wire

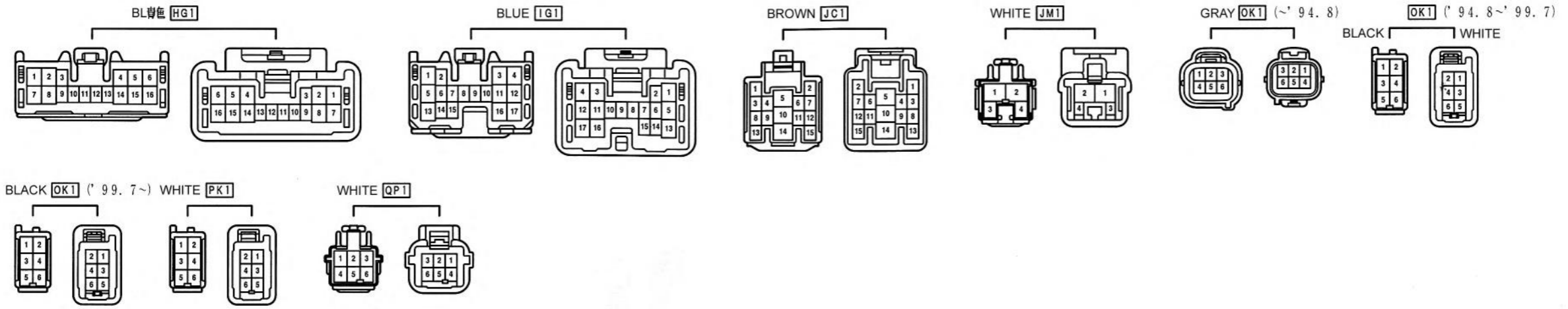

配線図集を入手ご希望の方は、お近くのトヨタ自動車販売店
又はトヨタ部品共販店に、代金を添えてお申し込み下さい。

2002年12月20日 印刷

2002年12月20日 発行 [無断転載を禁ず]

品番 6742505 実費 3900円 (消費税抜き)

編集発行 トヨタ自動車株式会社 サービス部

名古屋市東区泉1丁目23番22号

TECNO
トヨタサービス

トヨタ自動車株式会社